

MUTOH

OPERATION MANUAL

XPJ-1341WR-P

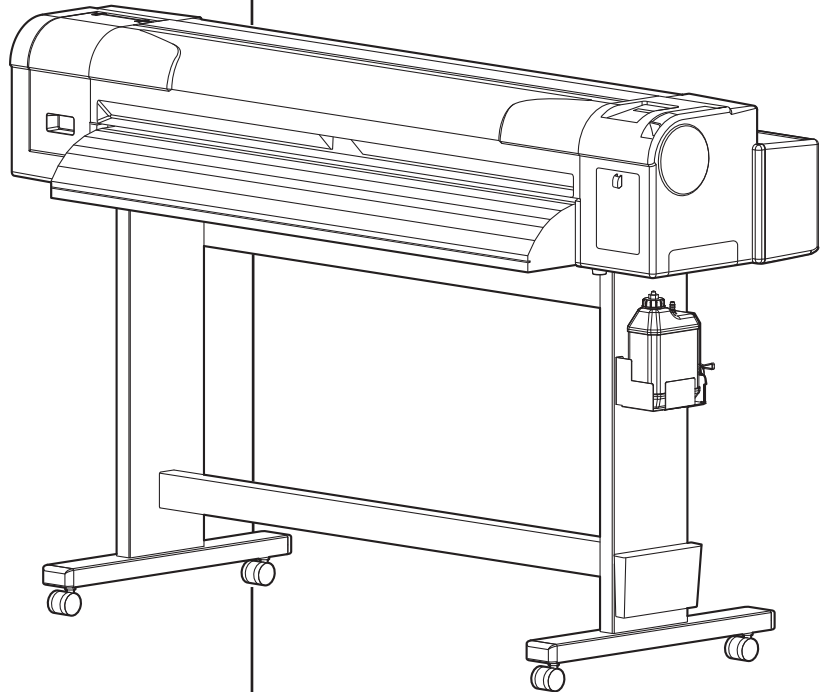

Read This Manual Before Using The
Printer.

Rev.

XPJ1341WRPE-A-01

Important Notice

1. For Users in Europe



The CE marking is a mandatory European marking for certain product groups to indicate conformity with the essential health and safety requirements set out in European Directives.

By affixing the CE marking, the manufacturer, his authorized representative, or the person placing the product on the market or putting it into service ensures that the item meets all the essential requirements of all applicable EU directives and that the applicable conformity assessment procedures have been applied.

2. For Users in the United States

This equipment has been tested and found to comply with the limits for a Class A digital device, pursuant to Part 15 of the FCC Rules.

These limits are designed to provide reasonable protection against harmful interference when the equipment is operated in a commercial environment.

This equipment generates, uses, and can radiate radio frequency energy and, if not installed and used in accordance with the instruction manual, may cause harmful interference to radio communications.

Operation of this equipment in a residential area is likely to cause harmful interference in which case the user will be required to correct the interference at his own expense.

3. Trademark Mentioned in this Manual

- MUTOH, XpertJet, XPJ-1341WR-P, MH-RTL are registered trademarks or product names of MUTOH INDUSTRIES LTD.
- Windows 11, Windows 10 are registered trademarks or product names of Microsoft Corporation.
- Other company and product names may be registered trademarks or product names.

NOTE

- Unauthorized copying or duplication of the whole or part of the contents of this manual is prohibited.
 - The product and the contents of this manual are subject to change without notice.
 - The information given by this manual is based on the best knowledge at the time of publication. Please inform MUTOH or MUTOH dealer you purchased the product from of any inaccuracies or mistakes contained herein.
 - MUTOH is not liable for any damages or accidents resulting from improper use which is not described in this manual.
-

About this Manual

1. Contents of the Manual

There are two manuals for this product.

Installation manual

Explains operating procedures along with unpacking, installation and preparation before use.

Operation Manual (this manual)

2. Purpose and Target Readers

This manual explains preparations before use and operation procedures for MUTOH Full Color Ink Jet Printer XPJ-1341WR-P.

This manual is prepared for the owners and operators of this printer.

Before using this printer, fully understand the contents and instructions in this manual.

3. Manual Configuration

Section	Description
1 Safety instructions	Explains warning terms, safety precautions and warning labels on the product that operators and installation personnel need to know.
2 Product overview	Explains the features of the printer along with the names and functions of each part.
3 Before using	Explains necessary steps before using the printer.
4 Handling the printer	Explains how to use the printer.
5 Panel setup menu	Explains the Setup menu of the printer.
6 Maintenance	Describes daily maintenance procedures of the product.
7 Troubleshooting	Provides common problems when using this product and possible solution.
8 Appendix	Describes specifications, optional accessories, supplies and user support of this printer.

NOTE

- **1 Safety instructions** to **4 Handling the printer** must be read before using the printer.
- Read **5 Panel setup menu** through **8 Appendix** as necessary.

4. Manual Notation

This section explains general cautions that must be followed in order to use this printer safely.







Warning	Meaning
 WARNING	Failure to follow the instruction may result in serious injury or death.
 CAUTION	Failure to follow the instruction may result in minor to medium injury or damage to the product.
 NOTE	Provides an instruction that should be observed or information that needs to be emphasized.
 TIP	Indicates useful tips for operating or understanding the printer.
	Indicates an action that must be avoided.
	Indicates an important instruction that must be followed.
	Indicates reference pages in this manual.

TABLE OF CONTENTS

1 Safety instructions

1.1	Types and meanings of warnings	14
1.2	Important safety instructions	15
1.3	Warning labels	19
1.3.1	Handling the warning labels.	19
1.3.2	Location and type of warning labels	19
1.4	Operating Instruction Labels	21
1.4.1	Cautions on Handling the Operating Instruction Labels	21
1.4.2	Locations and Types of Operating Instruction Labels	22

2 Product overview

2.1	Names of parts and functions.	24
2.1.1	Front section	24
2.1.2	Rear section.	26
2.1.3	Operation panel	27
2.1.4	Ink level indicator.	31
2.1.4.1	Ink level indicator.	32
2.2	Printer status	33
2.2.1	Ready-to-print status	33
2.2.2	Setup menu display	33
2.2.3	Changing printer status	33

3 Preparation before use

3.1	Power cord connection	36
3.2	Turning the power ON/OFF	40
3.2.1	Turning the power ON	40
3.2.2	Turning the power OFF	41
3.3	Installing ink	43
3.3.1	Installing 220 ml ink cartridges	45
3.3.2	Installing 1000 ml ink bags with optional high-capacity pack adapters	50
3.3.3	When using the high capacity pack adapters for the first time on the printer that ink has already been filled ⁵⁴	
3.4	Loading media	55
3.4.1	Loading roll media	55
3.4.2	Loading a roll media into the printer	58
3.4.3	Disabling Pressure Arms Individually	62
3.4.4	Specifying the User Type Setting	64

3.5	Test print	66
3.5.1	Nozzle check	69
3.5.2	Nozzle check F	70
3.5.3	Mode print	71
3.5.4	Setup print	72
3.5.5	Palette print	73
3.6	Adjust Print	74
3.6.1	Auto Adjust Print	75
3.6.2	Standard Adjust Print	80
3.6.2.1	Standard Confirmation Pattern	81
3.6.2.2	Standard Rough Adjustment Pattern	87
3.6.2.3	Standard Micro Adjustment Pattern	90
3.6.3	Custom Adjustment Pattern	93
3.6.3.1	Custom Confirmation Pattern	94
3.6.3.2	Custom Rough Adjustment Pattern	100
3.6.3.2.1	Rough Pattern ALL	100
3.6.3.2.2	Rough Pattern A to F	103
3.6.3.3	Custom Micro Adjustment Pattern	106
3.6.3.3.1	Fine Pattern ALL	106
3.6.3.3.2	Fine Pattern A to F	110
3.7	Connecting the printer to PC	113
3.7.1	System requirements	113
3.7.2	Preparing cables	113
3.7.3	Connecting a network interface cable	114
4	Handling the printer	
4.1	Print flow chart	116
4.2	Media	117
4.2.1	Media type	117
4.2.2	Cautions on handling media	117
4.2.3	Precaution on storing media after use	118
4.2.4	Printing area	118
4.2.5	Printhead Height	119
4.2.5.1	When raising the print head	120
4.2.5.2	When returning the print head to the original position	122
4.2.6	Media feed adjustment	124
4.2.6.1	Automatic PF adjustment method	125
4.2.6.2	Manual PF adjustment method using adjustment print	125
4.2.6.3	When you know the adjustment value (when changing the media or for similar operations)129	
4.3	Menu setups on the operation panel	130
4.3.1	Menu setup procedure	130
4.3.2	Panel setup menu overview	132
4.4	Operating from the operation panel	133
4.4.1	Feeding media	133
4.4.2	Automatic PF adjustment	134
4.4.3	Canceling printing	136

4.4.4	Cutting media	137
4.4.5	Cutting media manually	138
4.4.6	Changing and confirming settings while printing	139
4.4.6.1	Procedure for changing and confirming settings while printing	139
4.4.6.2	Settings that can be changed or confirmed while printing	140
4.4.7	Pausing printing	141
4.4.8	Normal Display while Printing	142

5 Panel setup menu

5.1	Setup menu	146
5.1.1	User Type menu	148
5.1.1.1	User Type menu	149
5.1.1.1.1	Print Mode menu	150
5.1.1.1.2	Effect menu	151
5.1.1.1.3	Adjust Print menu	152
5.1.1.1.4	Dist.Adj menu	155
5.1.1.1.5	Vacuum Fan menu	158
5.1.1.1.6	Media thickness menu	158
5.1.1.1.7	User Copy menu	159
5.1.2	Spitting menu	160
5.1.2.1	Spitting Pass count menu	162
5.1.3	Side Margin menu	163
5.1.4	Media Initial menu	164
5.1.5	Media Width menu	165
5.1.6	Output Mode menu	167
5.1.6.1	Ink Drying Time Menu	167
5.1.6.2	Page Gap menu	168
5.1.7	Method of Cut menu	168
5.1.7.1	Cut Pressure menu	169
5.1.8	Origin menu	169
5.1.9	Head Travel menu	171
5.1.10	Multi Strike menu	171
5.1.11	Strike Wait menu	172
5.1.12	Slant Check menu	172
5.1.13	Auto Cleaning menu	173
5.1.13.1	Standby Mode Auto Cleaning	173
5.1.13.2	While Printing Auto Cleaning	174
5.1.13.3	Before Print Auto Cleaning	174
5.1.14	Longstore menu	175
5.1.15	CR Maintenance menu	176
5.1.16	Initialization menu	176
5.1.17	IP Address menu	177
5.1.18	Subnet Mask menu	177
5.1.19	Gateway menu	178
5.1.20	Header Dump menu	179
5.1.21	Start Feed Menu	180
5.1.22	Alert Buzzer menu	180
5.1.23	Front Interlace Menu	181
5.1.24	Select Nozzle menu	182
5.1.24.1	Nozzle Settings menu	182

5.2	Test Print Menu	183
5.3	Cleaning menu	184
5.4	Menu Option menu	185
5.5	System Information menu	187
5.5.1	Ink Status menu	187
5.5.2	Life Times menu	188
5.6	Sleep Mode menu	188
5.6.1	Sleep Mode Cleaning Mode menu	189
5.6.2	Sleep Mode Start menu	189
5.7	Display menu	191
5.7.1	Language menu	191
5.7.2	Temperature menu	191
5.7.3	Length menu	192
5.7.4	Remain Ink menu	192
5.8	Job Status Menu	193
5.9	Roll Length Manage menu	194
5.9.1	Print menu	195
5.9.2	Simple Print menu	198
5.9.3	Scan menu	201
5.9.4	Roll Length menu	203
5.9.4.1	Roll Length menu	204
5.9.4.2	Print Stop menu	205
5.9.4.3	Near End menu	206
5.9.5	Auto Scan menu	206
5.9.6	Auto Print menu	207

6 Maintenance

6.1	Replacing consumable components	210
6.1.1	Replacing ink	210
6.1.2	Replacing Roll Media	218
6.1.3	Replacing Cutter	222
6.1.4	Replacing the cleaning wiper	230
6.2	Cleaning the printer	237
6.2.1	Cleaning the outer case	238
6.2.2	Cleaning the inside of the printer	239
6.2.3	Head cleaning	241
6.2.4	Cleaning the cleaning wiper	242
6.2.5	Cleaning around the capping unit	248
6.2.6	Cleaning around the print head	255
6.2.7	Cleaning the color sensor	262
6.3	Disposal of waste fluids	269
6.4	Moving or transporting the printer	271
6.4.1	Moving the printer	271
6.4.2	Transporting the printer	273

6.5	Long Storage and Initial Ink Charging	274
6.5.1	Long-term storage	274
6.5.2	Performing initial charging after head cleaning	278
6.5.2.1	Installing 220 ml ink cartridges	279
6.5.2.2	Installing high capacity pack adapters (option)	282
7	Troubleshooting	
7.1	Malfunctions and failures	286
7.1.1	Problems in installation and introduction	286
7.1.2	Cannot print at all.	287
7.1.3	Media-related troubleshooting	289
7.1.4	Printing-related troubleshooting	290
7.2	Error messages	293
7.2.1	Status messages	293
7.2.2	Message type error display and remedies	295
7.2.3	Error requiring restart.	298
7.3	The media has jammed	299
7.4	Smartchip Recovery	302
7.4.1	When the message "[***] S/C Recog. E" appears	302
7.4.2	When the message "[**] Check Color ->E" appears	302
8	Appendix	
8.1	Product specifications	304
8.1.1	Printer specifications	304
8.2	Interface specification	306
8.2.1	Network interface specification	306
8.3	Options/Supply list	307
9	Setup menu diagram	

1 Safety instructions

This chapter explains warning terms, safety precautions and warning labels on the product that operators and installation personnel must know.





- **When installing and operating this printer, be sure to follow the instructions and warnings in this document.**
-

1.1 Types and meanings of warnings

Depending on the level of risk, the following three symbols are used in this manual and the warning labels attached to the printer.













Understand the meanings of the following warning terms and follow the instructions in this manual.

Warning	Meaning
 WARNING	Failure to follow the instruction may result in serious injury or death.
 CAUTION	Failure to follow the instruction may result in minor to medium injury or damage to the product.
NOTE	Provides an instruction that should be observed or information that needs to be emphasized.

1.2 Important safety instructions

This section explains general cautions that must be followed in order to use this printer safely.

WARNING

-  Do not install this printer in the following places.
It may cause an injury if the printer falls down.
 - On a shaky stand
 - Uneven floor
 - Places where the printer gets vibration from the neighboring devices.
-  Do not step on or place heavy objects on the printer.
It may cause an injury if the printer falls down.
-  Do not block the vent on the product with cloth or other material.
If covered, the inside of the product may get hot and cause a fire.
-  Do not install the printer in a location with high humidity and dust.
It could lead to an electric shock and fire.
-  Do not use a damaged power cord.
It could lead to an electric shock and fire.
-  Do not connect or disconnect the power plug with a wet hand.
This could lead to an electric shock.
-  Do not connect an earth wire to the following places.
 - Gas pipes
There is a possibility of ignition and explosion.
 - Earth wire of telephone cables and lightning rods
Heavy current might flow whenever lightning strikes.
 - Water pipe and faucet
The earth might not work if a plastic pipe is connected in the middle of the metal pipe.
-  Do not insert or drop metal or flammable objects into the printer through openings such as a vent.
It could lead to an electric shock or fire.
-  If foreign substances or liquids such as water entered the printer, do not use the printer as it is.
It could lead to an electric shock or fire.
Immediately turn OFF the power switch, disconnect the power plug from the electric socket, and contact your local MUTOH dealer.
-  Wire each cable as instructed in the Operation Manual.
Any miswiring could cause fire.
-  Be sure to use the specified power cord.
Using power cords other than the specified can cause an electric shock or fire.
-  Make sure to use the specified power supply voltage only (AC 100 V to 120 V or AC 200 V to 240 V).
An incorrect voltage could cause an electric shock and fire.
-  Plug the power cord into the wall outlet (AC 100 V to 120 V or AC 200 V to 240 V).
Do not use power strips. This could generate heat and might cause fire.



Plug the power cord into the wall outlet that has the earth connection and make sure to connect the earth. If the earth is not connected, an electric shock or fire may occur.



Waste ink collected from this product is classified as industrial waste. Dispose of waste ink according to the local waste disposal regulations.

**CAUTION**

Follow these precautions when handling power cord.

- Do not modify the power cord.
- Do not put heavy objects on the power cord.
- Do not bend, twist or pull the power cord by force.
- Do not route the power cord near heating appliances.



Follow these precautions when handling the power supply plug. Any mishandling of the power cord could cause a fire.

- Do not allow dust or foreign objects to accumulate around the power plug.
- Make sure that the power plug is firmly inserted into the power socket.



Wear protective equipment (gloves, goggles or eye protection, protective mask, protective clothing) when handling ink.

Avoid contact with skin or eyes.

- If in eyes or on skin, wash with water immediately.
- Otherwise slight irritation or bloodshot eyes may occur. If irritation is present, seek medical advice/ attention immediately.



Do not disassemble ink cartridges.

If disassembled, ink may come into contact with eyes or skin.



Do not operate the media loading lever during the printer initialization or printing. The print head may touch the pressurizing roller, and cause a malfunction.



Do not use volatile solvents such as thinner, benzene, or alcohol. These solvents could cause damage to the paint.



Be careful that no moisture enters the printer. This could result in an electrical short circuit.



Do not open covers attached using screws under any circumstances. This may cause an electric shock or a malfunction.



When cleaning the cleaning wiper,

- Do not touch the cleaning wiper and head cap unit. Head cleaning may not be performed correctly because of oil from your hands.
- Make sure to wipe the print head using the cleaning stick. A wet cleaning stick may cause the print head to clog.
- Do not reuse the cleaning stick. Dust on the stick may damage the print head.



When cleaning around the capping unit,

- Use a dry cleaning stick. A damp stick can cause damage to the print head.
- Do not touch the tip of a cleaning stick with fingers. Skin oil will damage the print head.
- Do not reuse a cleaning stick. Dust on the stick will damage the print head.



When cleaning around the print head,

- Do not touch the nozzles of the print head.
Doing so may damage the print head.
- Do not touch the tip of the cleaning stick.
The oil from your hands will cause damage to the print head.
- Never use wet cleaning sticks.
Doing so may damage the print head.
- Do not reuse the cleaning stick.
Dust on the stick may damage the print head.



When cleaning the color sensor,

- Do not touch the nozzles of the print head.
Doing so may damage the print head.
- Do not touch the tip of the cleaning stick.
The oil from your hands will cause damage to the print head.
- Never use wet cleaning sticks.
Doing so may damage the print head.
- Do not reuse the cleaning stick.
Dust on the stick may damage the print head.
- Do not push the glass on the color sensor too hard with a cleaning stick. This will damage the glass.



Do not tilt the printer, prop it against a wall or turn it upside down.

The ink may leak from the printer.
MUTOH cannot guarantee that the printer can run properly.



Unpacking or moving this printer must be done by at least three people.



Mounting the printer on the dedicated stand must be done by at least three people.



When installing the dedicated stands, make sure to turn OFF the printer and unplug the power cord.
There may be a risk of electric shock.



When you do not use the printer for a long period, make sure to unplug the power cord from the power socket for safety.



Make sure to connect an earth wire to the earth connection that meets the following standards.

- Earth terminal of power socket
- Earth wire with copper plate which is buried at 650 mm or more, deep in the ground.



Before operation, make sure to read the Safety Data Sheet (SDS).



Keep the work area ventilated.

Failure to do so may cause feeling sick from odor or may lead to a fire.



When loading the roll media, place it on a flat surface such as a desk.
If the roll media is loaded with the scroller up, the scroller may be damaged.



Follow these precautions when cutting roll media.

Mishandling the razor blade may cause a cut on your finger or hand.

- When you hold media, do not place your finger on the media cut groove.
- Slowly cut the media along the media cut groove.



When cleaning the areas other than wiper or around the print head make sure to turn OFF the power and unplug the power cord.



Keep the printer level when moving it.



This device is not suitable for use in locations where children are likely to be present.

1.3 Warning labels

This section explains the handling, placement location and types of warning labels. Warning labels are attached to the area on the printer where special caution is needed. Understand the locations and the hazard descriptions associated with each label before operating the printer.

1.3.1 Handling the warning labels

When handling the warning labels, be careful about the following points.

NOTE

- Make sure all warning labels are legible.
If the letters or illustrations on the label are not clear, remove the dirt from the label.
- Use cloth, water and mild detergent for removing dirt from the warning label.
Avoid either organic solvents or gasoline.
- It is necessary to replace the labels if they are damaged, lost or illegible.
To replace, contact your local MUTOH dealer.

1.3.2 Location and type of warning labels

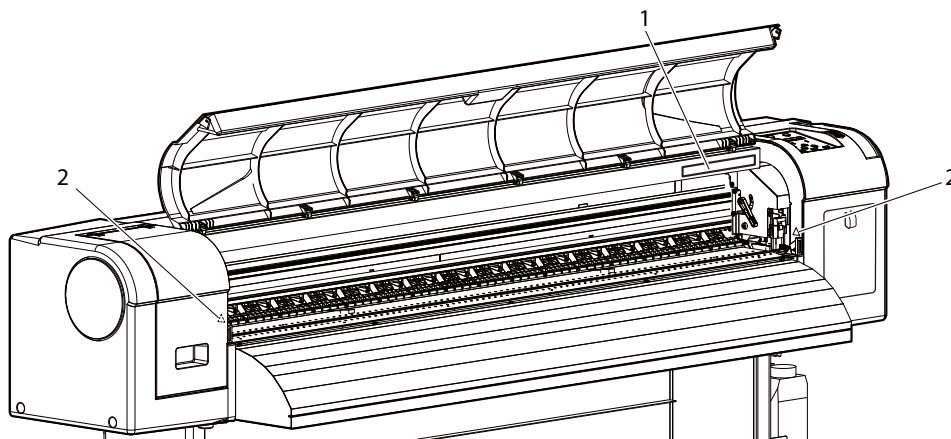

Warning labels are attached to the following locations:

(1) Front

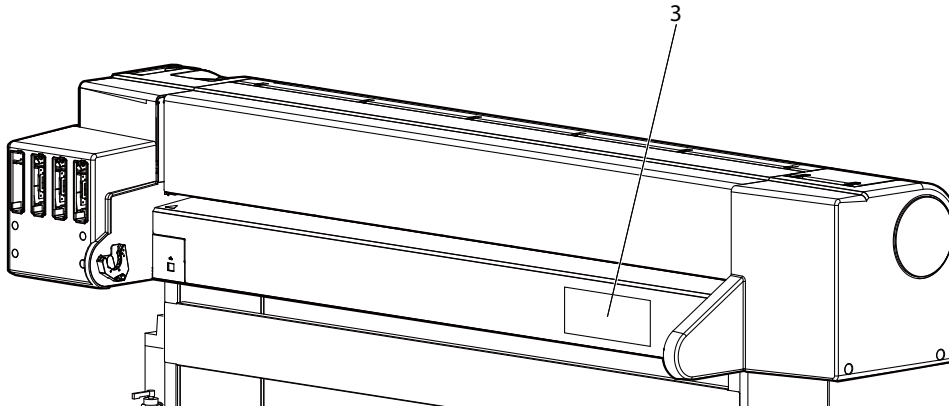

(2) Rear





No.	Types of warning labels			
1				
2	 <p>Pinch hazard. Keep hands and fingers clear of covers while opening or closing.</p>			
3	<div style="border: 1px solid black; padding: 10px;"> <p style="text-align: center;">MUTOH</p> <table style="width: 100%; border-collapse: collapse;"> <tr> <td style="width: 30%; vertical-align: top;"> <p>MODEL 型式 SERIAL NO. 製造番号</p> </td> <td style="width: 30%; vertical-align: top;"> <p>VOLTAGE 100 - 240V~ FREQUENCY 50 / 60 Hz CURRENT 2.4A - 1.2A</p> </td> <td style="width: 40%; vertical-align: top;"> <p>This device complies with Part 15 of the FCC Rules. Operation is subject to the following two conditions: (1) this device may not cause harmful interference, and (2) this device must accept any interference received, including interference that may cause undesired operation. CAN ICES-3 (A) / NMB-3 (A)</p> <p style="text-align: right;">MUTOH INDUSTRIES LTD. MADE IN JAPAN</p> </td> </tr> </table> <div style="display: flex; justify-content: space-between; margin-top: 10px;"> <div style="width: 45%;"> <p>Complies With UL 62368-1 CSA C22.2 No. 62368-1 E112544</p>  </div> <div style="width: 45%; border: 1px solid black; padding: 5px;"> <p>定格電圧 100V~ 定格周波数 50 / 60 Hz 消費電流 2.4A</p> </div> </div> <div style="margin-top: 10px;"> <p>注意</p> <p>この装置は、クラスA機器です。 この装置を住宅環境で使用すると電波妨害を 引き起こすことがあります。 この場合には使用者が適切な対策を講ずるよう 要求されることがあります。 VCCI-A</p> <p style="text-align: right;">武藤工業株式会社 日本製</p> </div> <div style="margin-top: 10px; border: 1px solid black; padding: 5px;"> <ul style="list-style-type: none"> • Apparatet må tilkoples jordet stikkontakt • Apparaten skall anslutas till jordat uttag • Laite on liitettävä suojakoskettimilla varustettuun pistorasiaan • Apparatets stikprop skal tilsluttes en stikkontakt med jord, som giver forbindelse til stikproppens jord </div> </div>	<p>MODEL 型式 SERIAL NO. 製造番号</p>	<p>VOLTAGE 100 - 240V~ FREQUENCY 50 / 60 Hz CURRENT 2.4A - 1.2A</p>	<p>This device complies with Part 15 of the FCC Rules. Operation is subject to the following two conditions: (1) this device may not cause harmful interference, and (2) this device must accept any interference received, including interference that may cause undesired operation. CAN ICES-3 (A) / NMB-3 (A)</p> <p style="text-align: right;">MUTOH INDUSTRIES LTD. MADE IN JAPAN</p>
<p>MODEL 型式 SERIAL NO. 製造番号</p>	<p>VOLTAGE 100 - 240V~ FREQUENCY 50 / 60 Hz CURRENT 2.4A - 1.2A</p>	<p>This device complies with Part 15 of the FCC Rules. Operation is subject to the following two conditions: (1) this device may not cause harmful interference, and (2) this device must accept any interference received, including interference that may cause undesired operation. CAN ICES-3 (A) / NMB-3 (A)</p> <p style="text-align: right;">MUTOH INDUSTRIES LTD. MADE IN JAPAN</p>		

”~” on the rating plate represents AC voltage.

NOTE

The following marks are for China’s safety standards.

	汉文	仅适用于海拔2000m以下地区安全使用。
	藏文	《2000m མངོས་ཀྱི་མཐོ་སྐོར་གྱི་ལུང་ལོ་རྒྱུ་ལྷོ་གླིང་གི་སྒོམ་ལྷོ་གླིང་གི་ལྷོ་གླིང་།》
	蒙古文	“ རྒྱ་མཚོ་འོ་ས་ལས་མཐོ་ཚད་ལྷི་2000མན་གྱི་ས་ལུང་ལོ་ནར་ཉེན་མེད་བེད་སྤྱོད་བྱས་འཇུག། ”
	壮文	Dan hab yungh youq gij digih haijbaz 2000m doxroengz haenx ancienz sawjyungh.
	维文	دېڭىز يۈزىدىن 2000 مېتر تۆۋەن رايونلاردا بىخەتەر ئىشلەتكىلى بولىدۇ
	汉文	“仅适用于非热带气候条件下安全使用。”
	藏文	《སྤོང་གི་མཐོ་སྐོར་གྱི་ལུང་ལོ་རྒྱུ་ལྷོ་གླིང་གི་སྒོམ་ལྷོ་གླིང་གི་ལྷོ་གླིང་།》
	蒙古文	“ ཚ་བའི་ས་ལུང་གི་གན་མ་གཤིས་མིན་པའི་ས་ལུང་ལོ་ནར་ཉེན་མེད་བེད་སྤྱོད་བྱས་འཇུག། ”
	壮文	Dan hab yungh youq gij dienheiq diuzgen mbouj dwg diegndat haenx ancienz sawjyungh.
	维文	غەيرى ئىسسىق بەلباغ ھاۋا كىلىماتى شارائىتىدا بىخەتەر ئىشلەتكىلى بولىدۇ

1.4 Operating Instruction Labels

This section explains the handling, placement location and types of operating instruction labels. This printer has some operating instruction labels with simplified operation procedures where special attention is required during operation. Make sure to fully understand the locations and contents of the labels before operating the printer.

1.4.1 Cautions on Handling the Operating Instruction Labels

When handling the operating instruction labels, note the following.





NOTE

- Make sure all operating instruction labels are legible.
If the letters or illustrations on the label are not clear, remove the dirt from the label.
- When cleaning the operating instruction labels, use a cloth, water, and mild detergent.
Avoid either organic solvents or gasoline.
- It is necessary to replace the operating instruction labels if they are damaged, lost or illegible.
To replace, contact your local MUTOH dealer.

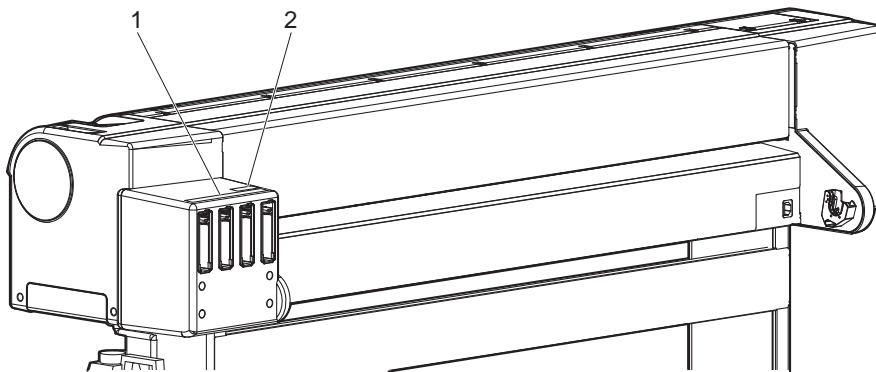
1.4.2 Locations and Types of Operating Instruction Labels

Operating instruction labels are attached to the following locations:



No.	Types of the operating instruction labels	Reference
1		<p> 3.3 Installing ink</p> <p> 6.1.1 Replacing ink</p>
2	 <p>Protective equipment label (Mask • Glasses • Gloves • Protective clothing) Wear protective equipment when handling ink.</p>	

2 Product overview

This chapter explains the names and functions of each part.

2.1 Names of parts and functions

This section explains the names and functions of each part.

2.1.1 Front section

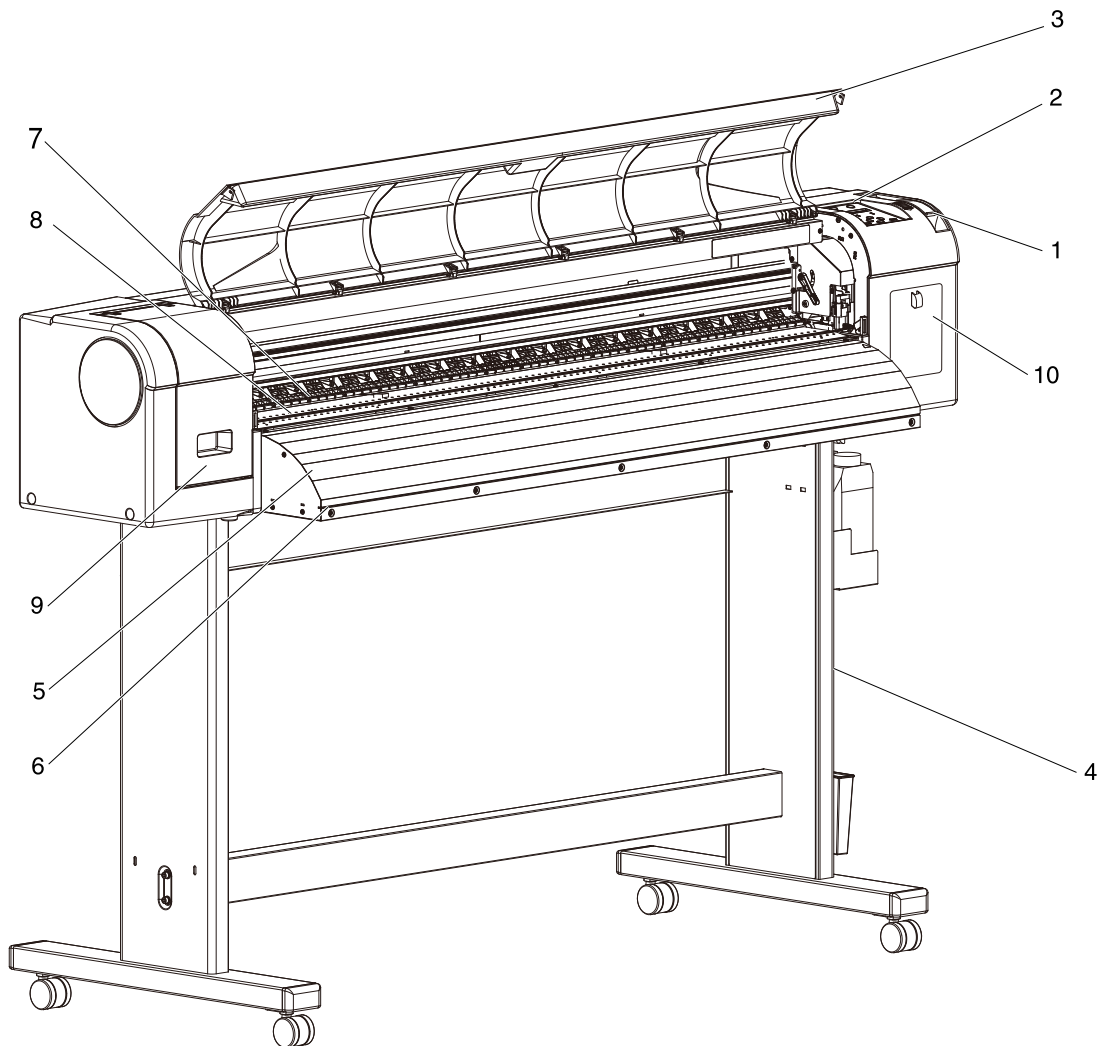

No.	Name	Function
1	Media loading lever	Hold down or release a roll media.
2	Operation panel	Specify various printer setting, check the printer status.
3	Front cover	Protect user from moving parts while the printer is operating. Open or close the cover when loading a roll media or removing media jam. It is normally closed.
4	Stand	Use it when installing the printer on a flat floor.
5	Media guide	Used for smooth media feeding while in printing or when loading a roll media in the printer.

No.	Name	Function
6	Media cut groove	Use it to cut media straight.
7	Pressurizing rollers	Installed inside of the front cover. Hold down the entire width of roll media when printing.
8	Platen	Installed inside of the front cover. Stabilizes the print side of the media.
9	Maintenance cover L	Prevent user from touching the inner mechanical section. Open and close the cover when <ul style="list-style-type: none">• cleaning around the print head.• cleaning the color sensor.• replacing the cutter. It is normally closed.
10	Maintenance cover R	Prevent user from touching the inner mechanical section. Open and close the cover when <ul style="list-style-type: none">• cleaning the cleaning wiper.• cleaning around the capping unit.• replacing the cleaning wiper. It is normally closed.

2.1.2 Rear section

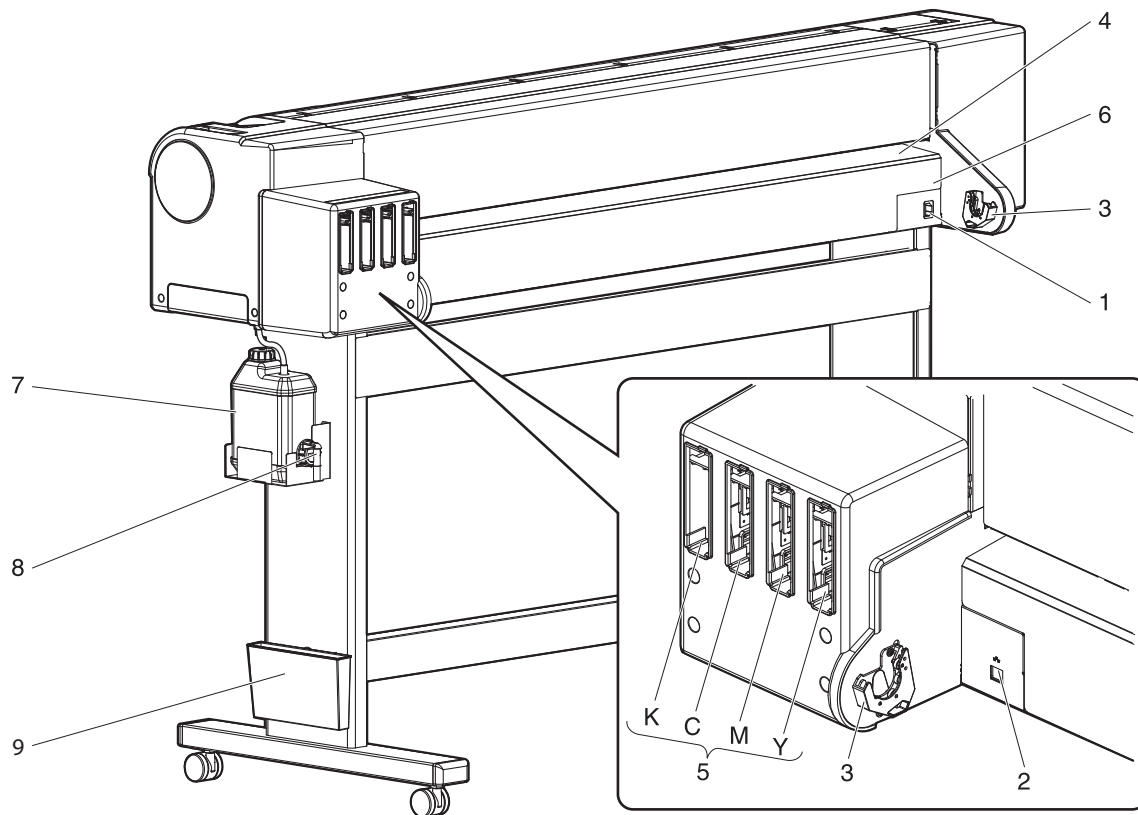

No.	Name	Function
1	AC inlet	Connect the power cord.
2	Network interface cable connector	Connect a network interface cable.
3	Scroller holder	Set the scroller here when using the roll media.
4	Media feed slot	Insert the leading edge of a roll media into the slot to load it in the printer.
5	Ink cartridge slot	Insert ink.
6	Media guide	Used for smooth media feeding while in printing or when loading a roll media in the printer.
7	Waste fluid tank	Collect waste ink from the printer.
8	Waste fluid valve	Open and close the valve when draining waste fluid from the waste fluid tank. It is normally closed.
9	Book holder	Store quick reference materials, etc.

2.1.3 Operation panel

The operation panel is used to specify various printer settings and check the printer status. Names of each operation key and status display along with the functions are explained.

TIP

- Refer to the following for details regarding the operation method of the operation panel.
- When performing menu setting from the operation panel: [4.3 Menu setups on the operation panel](#)
- When performing various operations in the operation panel: [4.4 Operating from the operation panel](#)

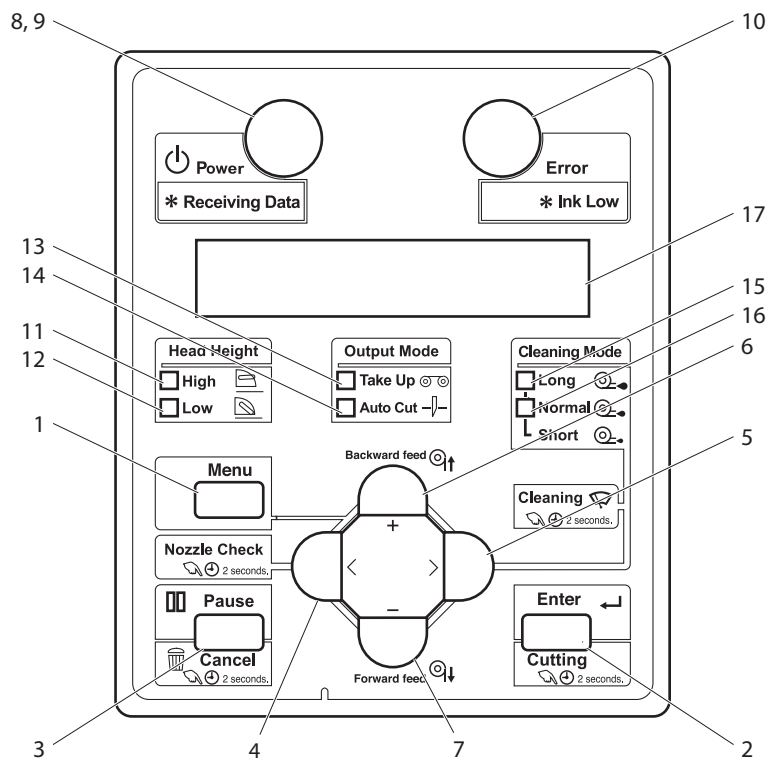

(1) Operation keys

NOTE

- The operation keys are assigned with different functions and names depending on printer status (Ready-to-print status or Setup menu).
For details about printer status, refer to "[2.2 Printer status](#)".
-  indicates the printer's power state "ON"/ "Standby". Pressing the [Power] key will switch between "ON" and "Standby".
In the Standby state, even when the power key is not turned on, the printer consumes a very small amount of power as long as the power cord is plugged in. In this manual, this state is also referred to as "power off".

No.	Name	Ready-to-print status	Setup menu
1	[Menu] key	Shifts to the Setup menu.	Shifts from Setup menu display to Ready-to-print status.
2	[Enter] key	<ul style="list-style-type: none"> Performs an automatic PF adjustment. Pressing this key while printing is paused will resume the print job. 	<ul style="list-style-type: none"> Select the menu and move to the submenu. Confirm and save the setting.
	[Cutting] key	Pressing this key for more than two seconds will cut the media.	—
3	[Pause] key	Pauses printing.	—
	[Cancel] key	<ul style="list-style-type: none"> While printing: Pressing the key for more than two seconds will forcibly terminate printing and will delete the print job. While receiving or analyzing data: Pressing the key for more than two seconds will delete the data already received and processed. 	<ul style="list-style-type: none"> Return to the upper menu without saving the changes made in the setting. Shifts from Setup menu display to Ready-to-print status.
4	[<] key	—	—
	[Nozzle Check] key	Pressing this key for more than two seconds will print a nozzle check F pattern.	—
5	[>] key	<ul style="list-style-type: none"> Select a cleaning mode. The lamp of the selected mode will light up in green. 	Move to the lower level menu.
	[Cleaning] key	Pressing the key for more than two seconds will start cleaning.	—
6	[Backward↑] key	Media is fed backward.	—
	[+] key	—	<ul style="list-style-type: none"> Move the selection to the previous menu item. Move the selection backward in a list. For numeric value input, increase the value.
7	[Forward↓] key	Media is fed forward.	—
	[-] key	—	<ul style="list-style-type: none"> Move the selection to the next menu item. Move the selection forward in a list. For numeric value input, decrease the value.

No.	Name	Ready-to-print status	Setup menu
8	[Power] key	Turns the printer ON and OFF.	Turns the printer ON and OFF.

(2) Display section

No.	Name	Color	Status	Description
9	Power lamp	Blue	Lamp ON	Power ON.
			Lamp blinks	<ul style="list-style-type: none"> Receiving and analyzing the data. Performing media initial operation.
			Lamp OFF	Power OFF.
10	Error lamp	Orange	Lamp ON	An error has occurred. Error content is displayed on the LCD.
			Lamp blinks	The remaining amount of ink is low.
			Lamp OFF	No error.
11	High lamp	Green	Lamp ON	The head height is set to High. <ul style="list-style-type: none"> When the Low lamp is also on, the head height is set to Middle.
			Lamp OFF	The head height is set to Low.
12	Low lamp	Green	Lamp ON	The head height is set to Low. <ul style="list-style-type: none"> When the High lamp is also on, the head height is set to Middle.
			Lamp OFF	The head height is set to High.
13	Take Up lamp	Green	Lamp ON	Output mode is set to "Take-up".
			Lamp OFF	Output mode is set to "Off" or "Auto cut".
14	Auto Cut lamp	Green	Lamp ON	Output mode is set to "Auto cut".
			Lamp OFF	Output mode is set to "Off" or "Take-up".
15	Long lamp	Green	Lamp ON	<ul style="list-style-type: none"> Cleaning mode is set to Long. When the Normal lamp is also on, the cleaning mode is set to Short.
			Lamp OFF	Cleaning mode is set to Normal.
16	Normal lamp	Green	Lamp ON	<ul style="list-style-type: none"> Cleaning mode is set to Normal. When the Long lamp is also on, the cleaning mode is set to Short.
			Lamp OFF	Cleaning mode is set to Long.
17	LCD display section	—	—	Displays operation status of the printer or an error message.

TIP

When an error requiring a restart (fatal malfunction for the printer operation) occurs, all lamps blink with an alarm.

7.2.3 Error requiring restart

If the error persists even when the malfunction is fixed, contact your local MUTOH dealer.

2.1.4 Ink level indicator

When the "Remain Ink" menu in the Display menu is set to "On", the ink level indicator that shows ink level or ink cartridge status is displayed on the LCD in the following cases:

☞ 5.7 Display menu

☞ 5.7.4 Remain Ink menu

- In ready-to-print status
 - ☞ 2.2.1 Ready-to-print status
- During printing
- When an ink or cartridge error is displayed
 - ☞ 7.2.2 Message type error display and remedies

The indicator and the corresponding ink colors on the label are shown below.





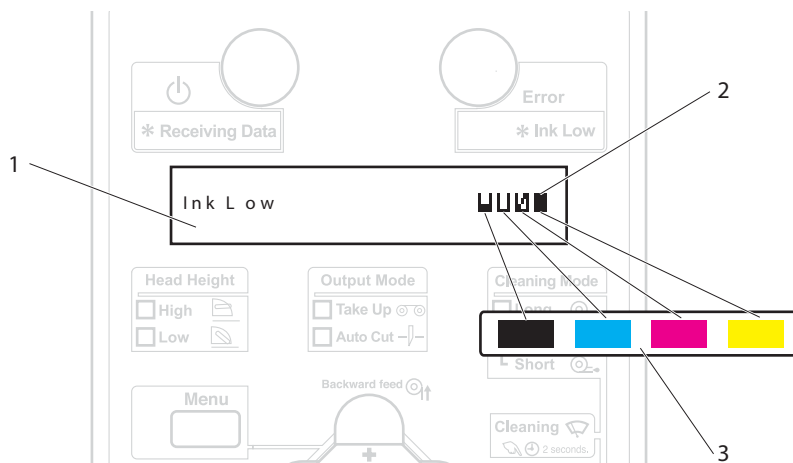



NOTE

- The ink color labels are attached to the top of the ink cartridge slots.



No.	Name
1	LCD display section
2	Ink level indicator
3	Ink color label (K, C, M, Y)

2.1.4.1 Ink level indicator

No.	Indicator	Ink level/ Ink cartridge status
1		Remaining ink amount : More than 80%, less than 100%
2		Remaining ink amount : More than 60%, less than 80%
3		Remaining ink amount : More than 40%, less than 60%
4		Remaining ink amount : More than 20%, less than 40%
5		Remaining ink amount : Less than 20% • The blinking indicates that smartchip recovery is being performed.  7.4 Smartchip Recovery
6		Ink low
7		Ink End
8		No cartridge

2.2 Printer status

This section explains printer status.

2.2.1 Ready-to-print status

Printing is possible when media is loaded.

The various operation for printing can be performed on the operation panel.

2.2.2 Setup menu display

Various settings regarding printing can be made from the operation panel.

The various functions for printing can be performed on the operation panel.

Display contents in the LCD monitor of the operation panel are as follows.

2.2.3 Changing printer status

Follow the procedure below and change printer status.

(1) Ready-to-print status → Setup menu display

Press the [Menu] key on the operation panel when the printer is Normal.

- “Menu 1: Setup>” is displayed on the operation panel and the display shifts to the Setup menu.

NOTE

- For details regarding the Setup menu, refer to “[4.3 Menu setups on the operation panel](#)”.
-

(2) Setup menu display → Ready-to-print status

To switch the operation panel display from the Setup menu to the Ready-to-Print state, do one of the followings:

- Press the [Cancel] or [Menu] key on the operation panel.
- In the Setup menu, leave the printer without any key input for three minutes.

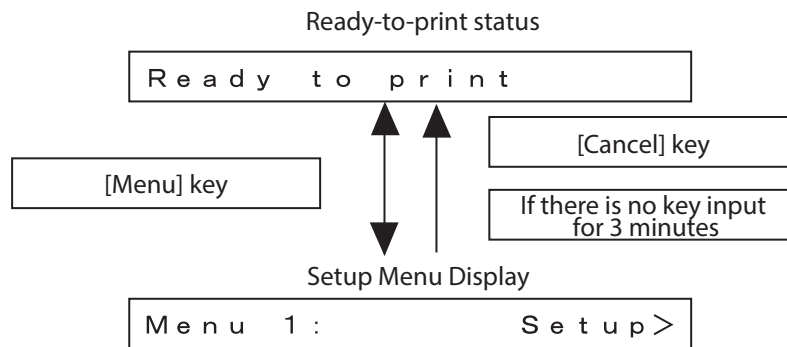

NOTE

- For details on Status message, refer to “[7.2.1 Status messages](#)”.

3 Preparation before use

This chapter explains necessary steps before using the printer.

3.1 Power cord connection

This section explains power cord connection.

WARNING

- **Be sure to use the designated power cord.**
Using a non-designated one can cause an electric shock or fire.
- **Use a power cord which meets the safety standards, power supply voltage and plug shape of the country where this printer is used.**
- **The power cord should have the protective ground terminal and make sure to plug in securely.**
- **Do not use a damaged power cord.**
It could lead to an electric shock and fire.

CAUTION

- **Follow these precautions when handling power cord.**
 - **Do not modify the power cord.**
 - **Do not put heavy objects on the power cord.**
 - **Do not bend, twist or pull the power cord by force.**
 - **Do not route the power cord near heating appliances.**

NOTE

- Contact your local MUTOH dealer in case of power cord damage.
- This product is also designed for IT power distribution system with phase-to-phase voltage 230V.

Follow the procedure below to connect the power cord.

1. Make sure that the printer is turned OFF.

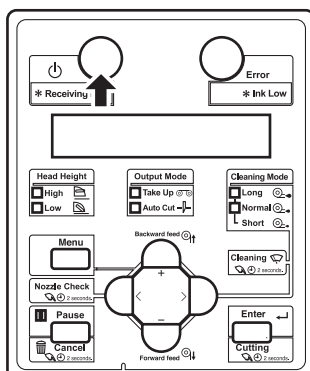

NOTE

- The power is ON when the [Power] key of the operation panel is pressed in. Press the key again to turn OFF the power.

2. Connect the power cord to the AC inlet on the back of the printer.

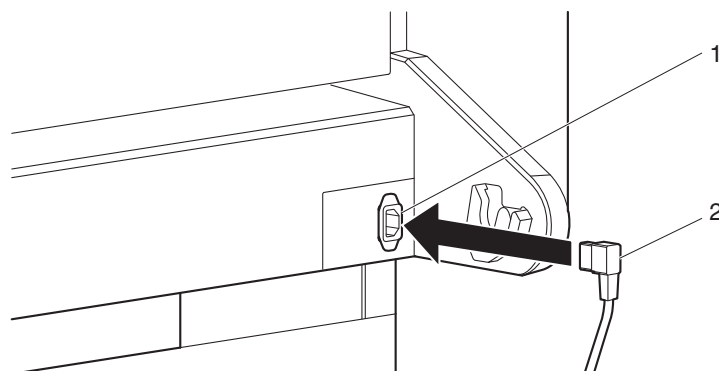

No.	Name
1	AC inlet
2	Power cord

3. Plug the power cord firmly into the wall outlet.

⚠ WARNING

- **Do not connect or disconnect the power plug with a wet hand.**
This could lead to an electric shock.
- **Make sure to use the specified power supply voltage only (AC 100 V to 120 V or AC 200 V to 240 V).**
An incorrect voltage could cause an electric shock and fire.
- **Plug the power cord into the wall outlet (AC 100 V to 120 V or AC 200 V to 240 V).**
Do not use power strips.
This could generate heat and might cause fire.
- **Plug the power cord into the wall outlet that has the earth connection and make sure to connect the earth.**
If the earth is not connected, an electric shock or fire may occur.
- **Do not connect an earth wire to the following places.**
 - **Gas pipes**
There is a possibility of ignition and explosion.
 - **Earth wire of telephone cables and lightning rods**
Heavy current might flow whenever lightning strikes.
 - **Water pipe and faucet**
The earth might not work if a plastic pipe is connected in the middle of the metal pipe.

⚠ CAUTION

- **Follow these precautions when handling the power supply plug.**
Any mishandling of the power cord could cause a fire.
 - **Do not allow dust or foreign objects to accumulate around the power plug.**
 - **Make sure that the power plug is firmly inserted into the power socket.**
 - **When you do not use the printer for a long period, make sure to unplug the power cord from the power socket for safety.**
- **Make sure to connect an earth wire to the earth connection that meets the following standards.**
 - **Earth terminal of power socket**
 - **Earth wire with copper plate which is buried at 650 mm or more, deep in the ground.**

NOTE

- Contact your local MUTOH dealer if the earth connection cannot be established, or if the earth connection is not given.
- Do not unplug the printer while the printer is powered ON.
If unplugged, allow one minute or more before inserting the plug in the power socket again.

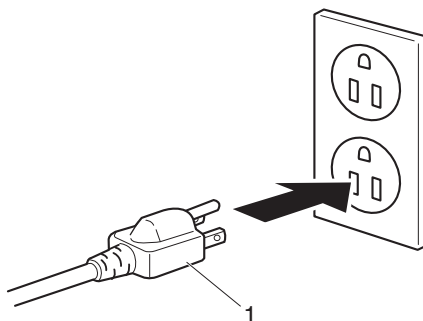

No.	Name
1	Power plug

3.2 Turning the power ON/OFF

This section explains how to turn the printer ON/OFF.

3.2.1 Turning the power ON

Follow the procedure below to turn the power ON.

1. Press the [Power] key on the operation panel to turn ON the printer.
 - Power lamp on the operation panel turns on (blue).

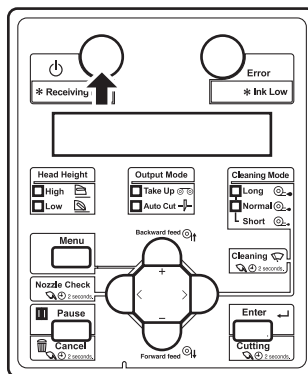

- The printer starts initial operation.
- After the initial operation is complete, the printer will be in ready-to-print mode.

NOTE

- If there is a problem during the initial operation, a message is displayed on the operation panel and the printer may stop operating. If operation has stopped, refer to “7 Troubleshooting” and take an appropriate action.

3.2.2 Turning the power OFF

Follow the procedure below to turn the printer OFF.

1. Check that
 - Printing or other operations are not in progress.
 - "Ready to Print" is displayed on the operation panel.
2. Press the [Power] key on the operation panel to turn OFF the printer.
 - The Power lamp on the operation panel is turned off.

NOTE

- The printer is powered ON if
 - the [Power] key is pressed in.
 - power lamp is on (blue).

Press the key again to turn OFF the power.

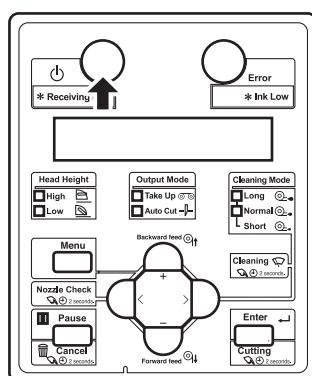

- The printer starts the procedure to turn the power OFF.
- "Power Off" is displayed on the operation panel.
- All the lamps on the operation panel and the LCD monitor turn OFF.
- The printer automatically turns the power OFF.

NOTE

- If there is a problem during turning OFF operation, a message is displayed on the operation panel and the printer may stop operating.
If operation stops, refer to "[7 Troubleshooting](#)" and take an appropriate action.
- To turn the printer ON again, wait at least ten seconds after the printer is turned off.

3. Push the media loading lever towards the back if the printer will not be in use for a while.

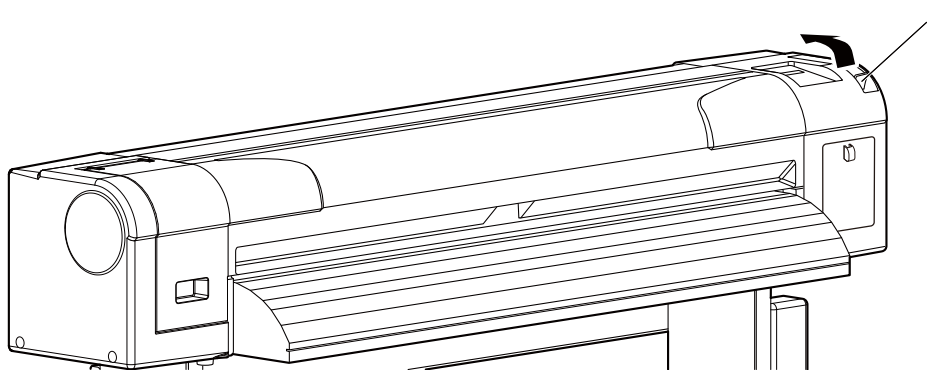

No.	Name
1	Media loading lever

3.3 Installing ink

This section describes the procedure to install the ink cartridges and high capacity pack adapter.

CAUTION

- Before operation, make sure to read the Safety Data Sheet (SDS).
- Wear protective equipment (gloves, goggles or eye protection, protective mask, protective clothing) when handling ink.
Avoid contact with skin or eyes.
 - If in eyes or on skin, wash with water immediately.
 - Otherwise slight irritation or bloodshot eyes may occur. If irritation is present, seek medical advice/ attention immediately.
- Do not disassemble ink cartridges.
If disassembled, ink may come into contact with eyes or skin.
- Do not perform the following operations during ink charging.
 - Do not turn OFF the printer.
 - Do not unplug the power cord.
 - Do not open the cover.
 - Do not push the media loading lever towards the back.

NOTE

- Do not use the same ink cartridge on different printers. The cartridge will not be usable from that time onward.
- Make sure to use genuine ink cartridges or ink bags.
This printer is designed to use only with the genuine ones.
The use of non-genuine ink may cause blurred print or detection failure of ink end.
The warranty does not cover damages caused by such use.
- For types and details of ink cartridges and ink bags, contact your local MUTOH dealer.
- Do not give ink cartridges or ink bags strong shakes.
Doing so may cause ink leakage.
- Do not disassemble ink cartridges or ink bags.
A disassembled ink cartridge cannot be used.
- Make sure to use the dedicated cleaning fluid
(Model number: RJ-FGCLS, VJ-AQU-CL600U).
- Shake the ink cartridges or ink bags gently before installing them to deliver best print quality.
- When an ink cartridges or ink bags is moved from a cold place to warm place, leave it in the new environment for at least three hours before printing.
- Do not insert or remove the ink cartridges or ink bags more than 10 times.
Doing so will make it unusable even though ink remains.
- The ink cartridges and ink bags for this printer have dedicated IC chip on them.
If removing/inserting the ink cartridges or ink bags and high capacity pack adapters (option) in the following situations, the information within the IC chips may be damaged and the cartridges cannot be used.
 - During printing
 - For several seconds after inserting the ink cartridge

3.3.1 Installing 220 ml ink cartridges

Follow the procedure below to install the 220 ml ink cartridge.

1. Turn the printer ON.

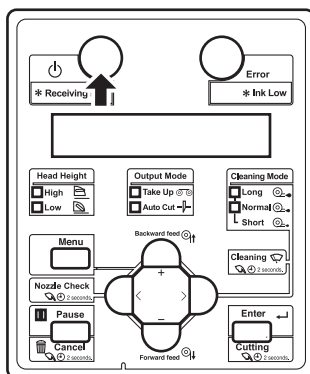

- The printer starts the initializing operation.
- After the initial operation is complete, “Start Ink Charge – > E” is displayed on the operation panel.

2. Press the [Enter] key on the operation panel.

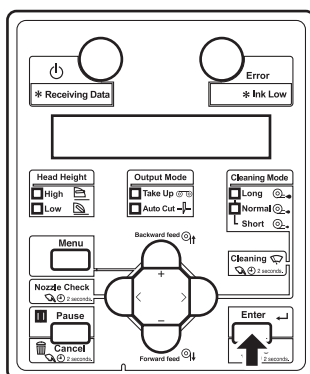

- If “Remove Cartridges” is displayed on the operation panel, remove all the ink cartridges.
- “Insert Cleaning cart.” is displayed on the operation panel.
- “Busy-Washing” is displayed on the operation panel and the printer starts head cleaning.

3. Take out the cleaning cartridges (4 pieces) from the packages.

4. Insert the cleaning cartridges into the ink cartridge slots.

- Keep ▲ mark of the cleaning cartridge facing up and insert into the slot.
- Insert the cleaning cartridge all the way to the end of the slot.

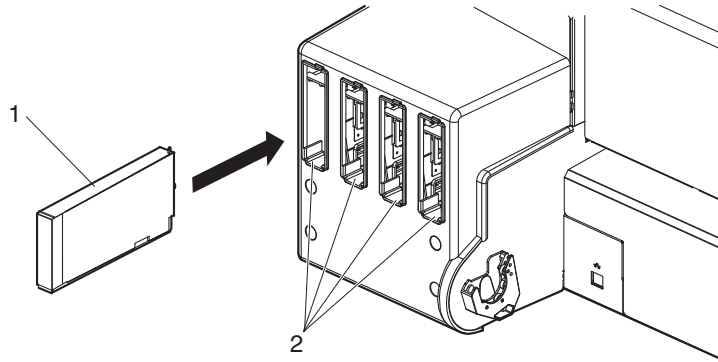

No.	Name
1	Cleaning cartridge
2	Ink cartridge slots

- When all cleaning cartridges are installed, “Busy-Washing” is displayed on the operation panel, and the printer starts charging the cleaning fluid.
- When the cleaning fluid has been charged, “Remove Cartridges” is displayed on the operation panel.

5. Remove all cleaning cartridges.

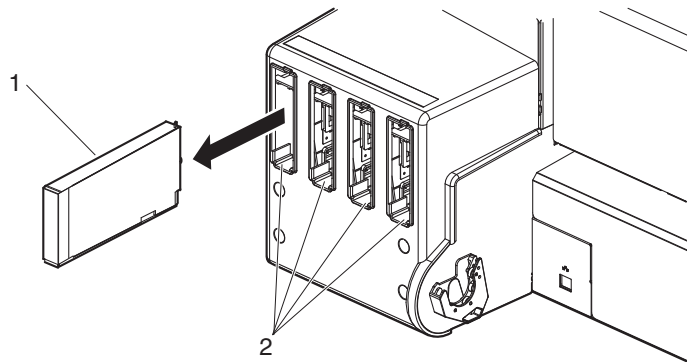

No.	Name
1	Cleaning cartridge
2	Ink cartridge slots

- “Busy-Washing” is displayed on the operation panel and the printer starts head cleaning.

6. After the head cleaning is complete, "Insert CleaningCart." is displayed on the operation panel.

7. Repeat steps 4 and 5.

- When head cleaning is complete, “Wash retry? No” is displayed on the operation panel.

NOTE

- To perform head cleaning again before ink charging, press the [+] or [-] key on the operation panel to select “Yes”, and press the [Enter] key to perform head cleaning.

8. Press the [Enter] key on the operation panel.

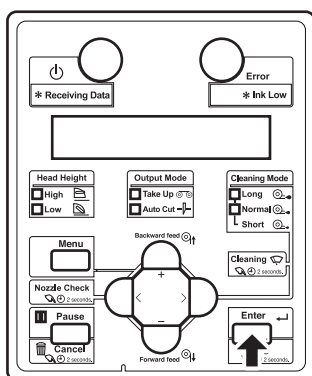

- “Insert InkCartridges” is displayed on the operation panel.

9. Take out the new ink cartridge from the package.

10. Agitate the ink cartridges.

- Hold the ink cartridge facing the ink plug up and wait for 3 seconds.
- Next invert the cartridge and wait for 3 seconds.
- Repeat that 3 times.

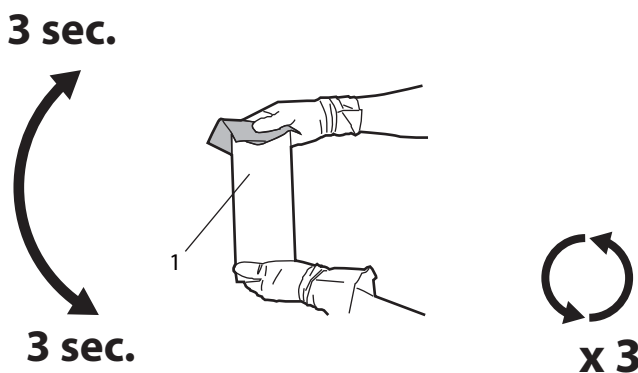

No.	Name
1	Ink cartridge

11. Insert the ink cartridges into Ink cartridge slots.

- Make sure that the ink cartridges are inserted into the correct slots. Match the color of the label on the cartridge with the ink color label on each slot.
- Keep ▲ mark of the ink cartridge facing up and insert into the slot.
- Insert the ink cartridge all the way to the end of the slot.

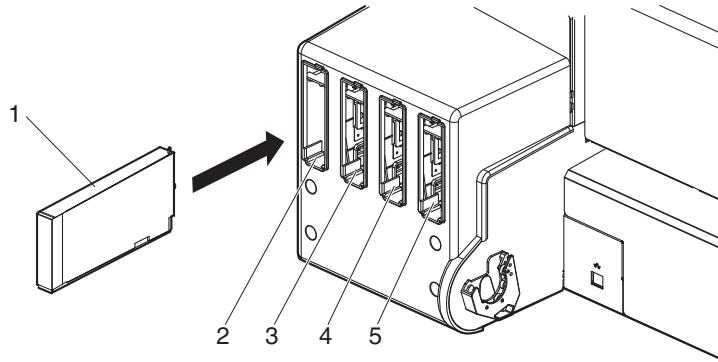

No.	Name
1	Ink cartridge
2	Ink cartridge slot K
3	Ink cartridge slot C
4	Ink cartridge slot M
5	Ink cartridge slot Y

- “Ink Refill **%” is displayed on the operation panel and initial ink charge starts.
- Initial ink charge takes about 13 minutes.
The printer repeats ink filling and pausing during the initial ink charge.
- When “100%” is displayed, the initial ink charge is complete.

 **CAUTION**

- **Follow these precautions during ink charging. If charging is interrupted, ink will be lost when charging is resumed.**
 - **Do not turn OFF the printer.**
 - **Do not unplug the power cord.**
 - **Do not open the front cover.**
 - **Do not open the maintenance cover.**
 - **Do not push the media loading lever towards the back.**

- After the initial ink charge is complete, “Media End” is displayed on the operation panel.

NOTE

- If the printer performs the nozzle check printing immediately after initial ink charge is complete, the following results may occur.
- Printed lines become blurred.
- The data is partially not printed.

In such cases, follow “**6.2.3 Head cleaning**” and perform “Little Charge”. Then, run a nozzle check.

If there is no improvement in the print result even after performing “Little Charge”, leave the printer for at least one hour. Then, perform “Little Charge” again and run a nozzle check.

If the problem still persists contact your local MUTOH dealer.

3.3.2 Installing 1000 ml ink bags with optional high-capacity pack adapters

By using the optional high-capacity pack adapters, you can install 1,000 ml ink bags on this printer.

Follow these steps.

1. Turn the printer ON.

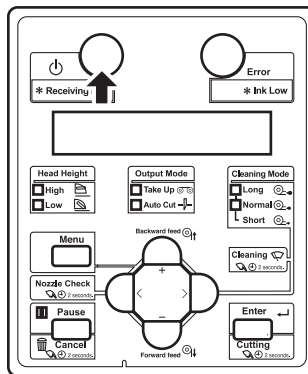

- The printer starts the initializing operation.
 - After the initial operation is complete, “Start Ink Charge – > E” is displayed on the operation panel.
2. Press the [Enter] key on the operation panel.

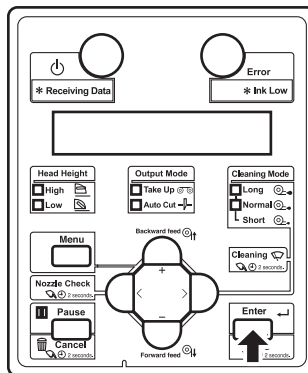

- If “Remove Cartridges” is displayed on the operation panel, remove all the ink cartridges.
 - “Insert Cleaning cart.” is displayed on the operation panel.
 - “Busy-Washing” is displayed on the operation panel and the printer starts head cleaning.
3. Take out the cleaning cartridges (4 pieces) from the packages.

4. Insert the cleaning cartridges into the ink cartridge slots.

- Keep ▲ mark of the cleaning cartridge facing up and insert into the slot.
- Insert the cleaning cartridge all the way to the end of the slot.

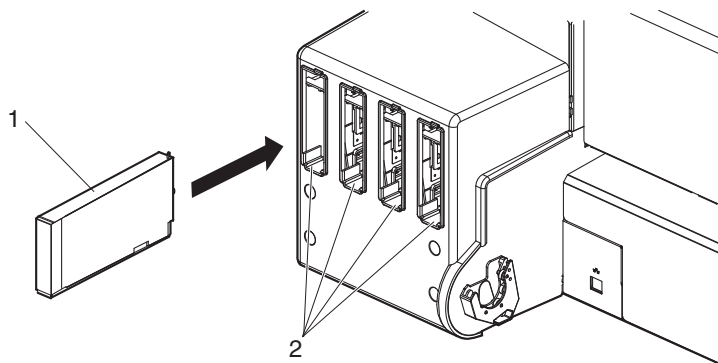

No.	Name
1	Cleaning cartridge
2	Ink cartridge slots

- When all cleaning cartridges are installed, “Busy-Washing” is displayed on the operation panel, and the printer starts charging the cleaning fluid.
- When the cleaning fluid has been charged, “Remove Cartridges” is displayed on the operation panel.

5. Remove all cleaning cartridges.

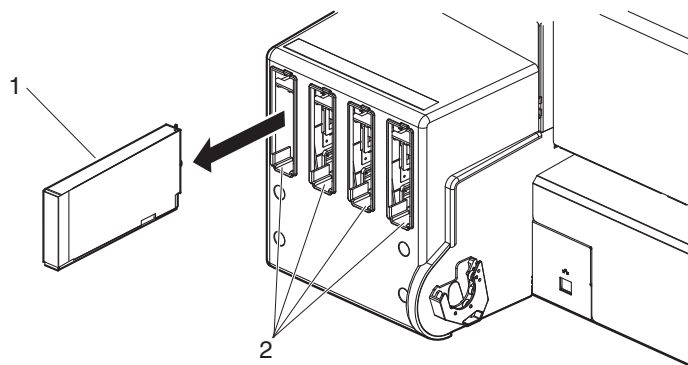

No.	Name
1	Cleaning cartridge
2	Ink cartridge slots

- “Busy-Washing” is displayed on the operation panel and the printer starts head cleaning.

6. After the head cleaning is complete, "Insert CleaningCart." is displayed on the operation panel.

7. Repeat steps 4 and 5.

- When head cleaning is complete, “Wash retry? No” is displayed on the operation panel.

NOTE

- To perform head cleaning again before ink charging, press the [+] or [-] key on the operation panel to select “Yes”, and press the [Enter] key to perform head cleaning.

8. Press the [Enter] key on the operation panel.

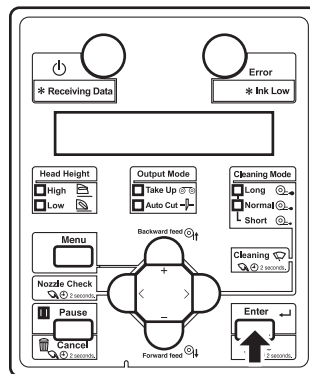

- “Insert InkCartridges” is displayed on the operation panel.

9. Take out the new ink bag from the package.

10. Install the ink bag and a smart chip card to the high capacity pack adapter.

11. Agitate the ink bag.

- To avoid removing the ink bag from the high-capacity pack adapter, use one hand to hold the top of the ink bag. Rotate the plug of the ink bag vertically and hold for 3 seconds.
- Then, invert the ink bag with the adapter and hold for 3 seconds.
- Repeat that 3 times.

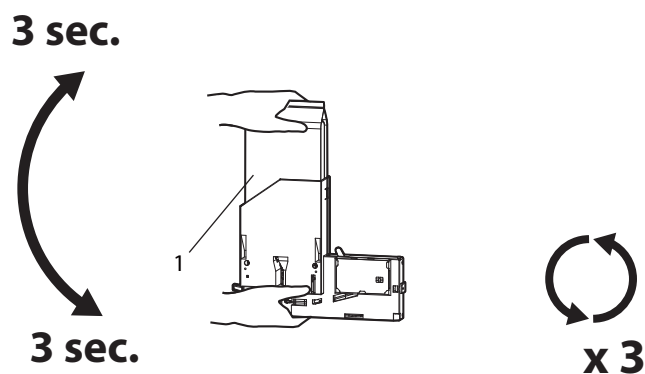

No.	Name
1	Ink bag

12. Insert the High capacity ink pack adapters into Ink cartridge slots.

NOTE

- Do not insert the high capacity pack adapter into the ink cartridge slot without an ink bag attached. The information of the remaining amount will be overwritten and the cleaning fluid bag will not be usable.

- Insert the high capacity pack adapter all the way to the end of the slot.

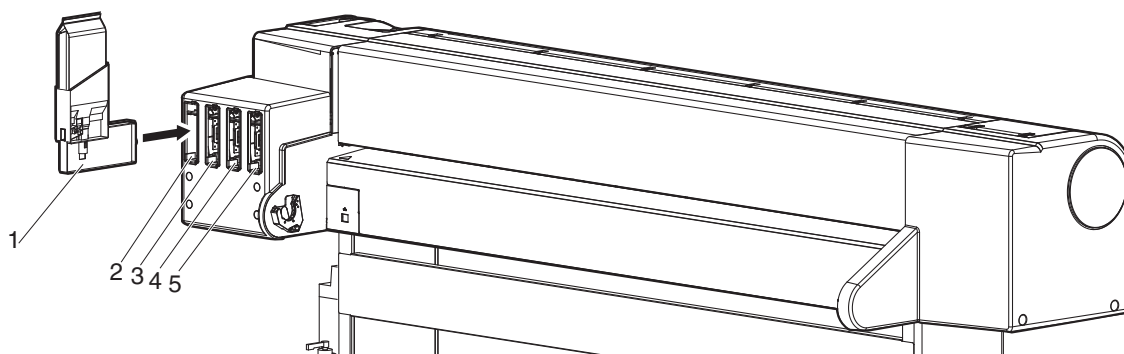

No.	Name
1	High capacity pack adapter
2	Ink cartridge slot K
3	Ink cartridge slot C
4	Ink cartridge slot M
5	Ink cartridge slot Y

- When the high-capacity pack adapters are installed, “Ink Refill **%” is displayed on the operation panel and the printer starts ink charging.
- Initial charging takes about 13 minutes.
The printer repeats ink filling and pausing during the ink charging.
- When “100%” is displayed, the ink charging is complete.

CAUTION

- **Do not perform the following operations during ink charging. If charging is interrupted, ink will be lost when charging is resumed.**
 - **Do not turn OFF the power of the printer.**
 - **Do not unplug the power cord of the printer.**
 - **Do not open the front cover.**
 - **Do not open the maintenance cover.**
 - **Do not push the media loading lever towards the back.**

- After the ink charging is complete, “Media End” is displayed on the operation panel.

NOTE

- If the printer perform the nozzle check printing immediately after initial ink charging is complete, the following results may occur.
- Printed lines become blurred.
- The data is partially not printed.

In such cases, follow “**6.2.3 Head cleaning**” and perform “Little Charge”. Then, run a nozzle check.

If there is no improvement in the print result even after performing “Little Charge”, leave the printer for at least one hour. Then, perform “Little Charge” again and run a nozzle check.

If the problem still persists, contact your local MUTOH dealer.

3.3.3 When using the high capacity pack adapters for the first time on the printer that ink has already been filled

In the following cases, make sure to perform initial ink charging from the Cleaning menu in order to avoid air entering the printer's ink tube, causing nozzle clogging.

- When using the high-capacity pack adapters for the first time on the printer that ink has already been filled
- When replacing an adapter on the high-capacity pack adapter with a new one

5.3 Cleaning menu

3.4 Loading media

This section explains how to load a roll media, and specify the settings for each media type.

NOTE

Refer to the following for details about handling media.

 [4.2 Media](#)

3.4.1 Loading roll media

This section describes the procedure to load the roll media.

To load it, use the scroller included with the printer.

NOTE

The following roll media can be loaded on the scroller included with the printer.

- Roll media with 3-inch paper core: Outer diameter up to 150 mm, Weight up to 19 kg
- Roll media with 2-inch paper core: Outer diameter up to 150 mm, Weight up to 19 kg

Follow the procedure below to load the roll media.



CAUTION

- **When loading a roll media onto the scroller, place the roll media on a flat table and load it onto the scroller.**
If the roll media is loaded with the scroller up, the scroller may be damaged.

- When using the roll media with 2-inch paper core, remove the attachments for 3-inch paper core from the movable media stopper and fixed media stopper.

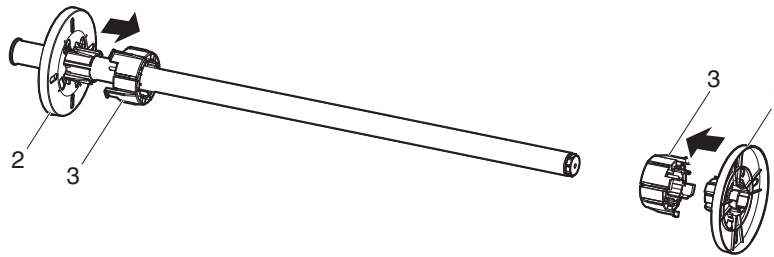

No.	Name
1	Movable media stopper
2	Fixed media stopper
3	Attachments for 3-inch paper core

- To set the roll media on the scroller, make sure that the paper is rolled counter-clockwise when seen from the fixed media stopper.
- Insert the roll media all the way till its core touches the right edge of the fixed media stopper.

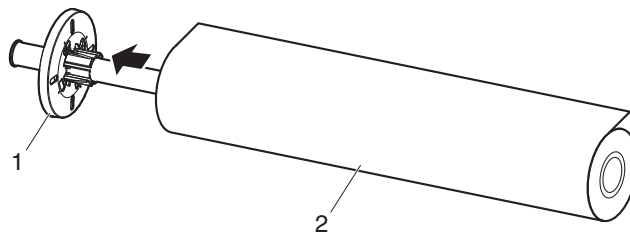

No.	Name
1	Fixed media stopper
2	Roll media

- Attach the movable media stopper firmly to the core of the roll media.

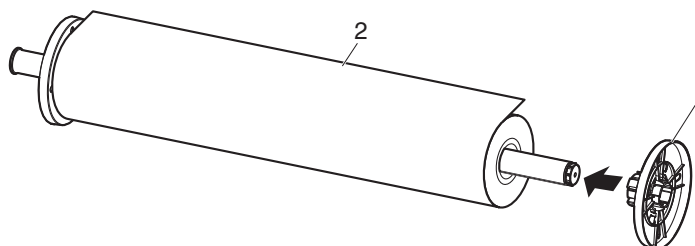

No.	Name
1	Movable media stopper
2	Roll media

5. Set the scroller on the holder with the fixed media stopper on the ink cartridge slot side.

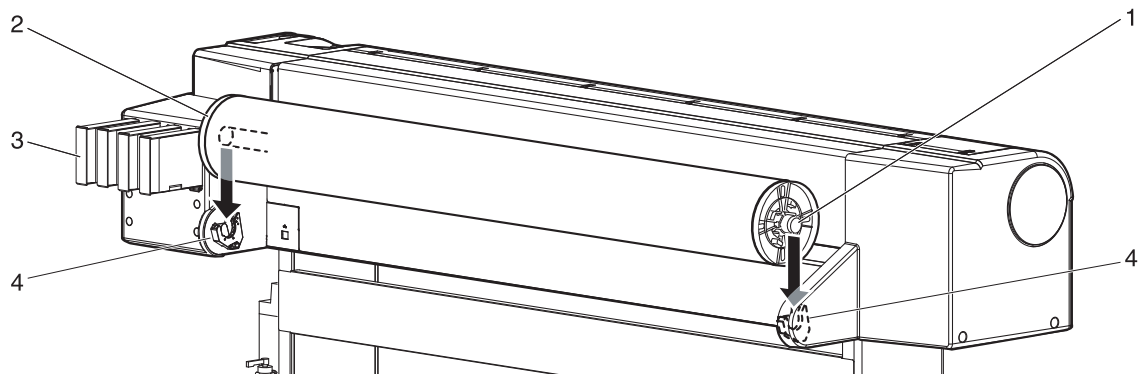

No.	Name
1	Scroller
2	Fixed media stopper
3	Ink cartridge slots
4	Scroller holder

3.4.2 Loading a roll media into the printer

This section explains how to load a roll media into the printer.

Follow the procedure below to set the roll media.

1. Turn the printer ON.

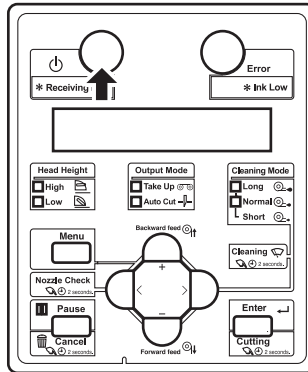

CAUTION

- Do not operate the media loading lever during the printer initialization or printing. The print head may touch the pressurizing roller, and cause a malfunction.

- The printer starts the initializing operation.
 - “Media End” is displayed on the operation panel.
2. Push the media loading lever towards the back.

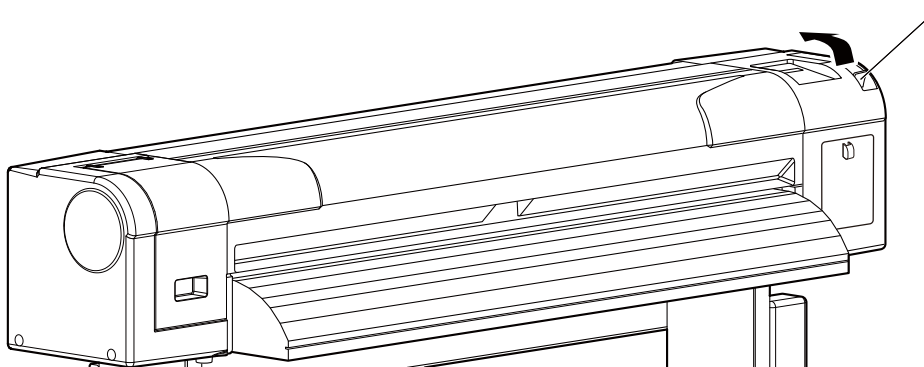

No.	Name
1	Media loading lever

- “Load Media” is displayed on the operation panel.

3. Insert the leading edge of the roll media into the media feed slot.

NOTE

- If the end of the roll media is not wound tightly, wind it tightly again, and then load it.

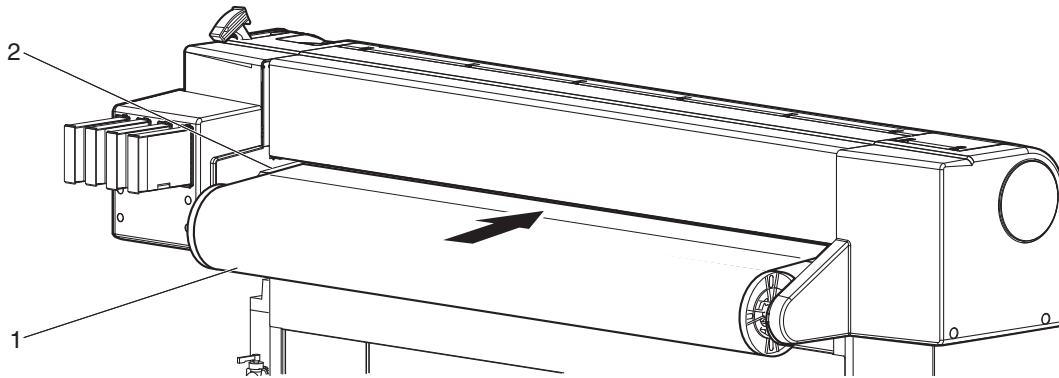

No.	Name
1	Roll media
2	Media feed slot

4. Open the front cover to pull the roll media towards you.

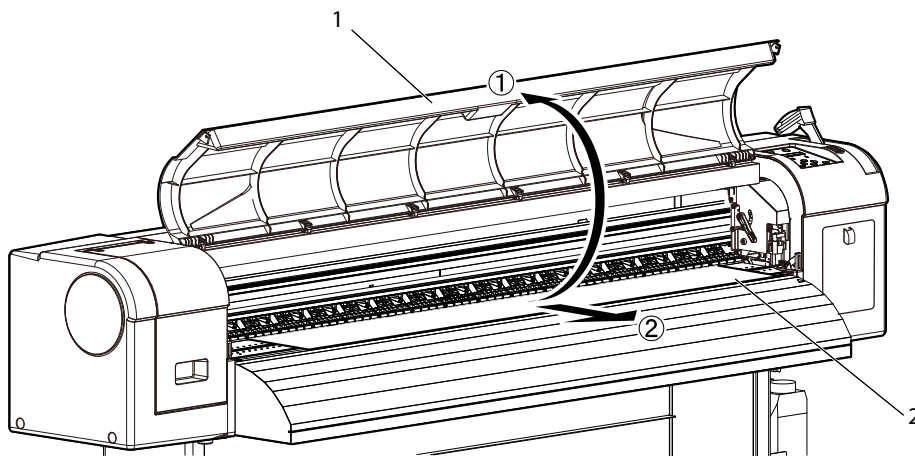

No.	Name
1	Front cover
2	Roll media

5. Wind back the roll media with the scroller to remove a media warp or skew.

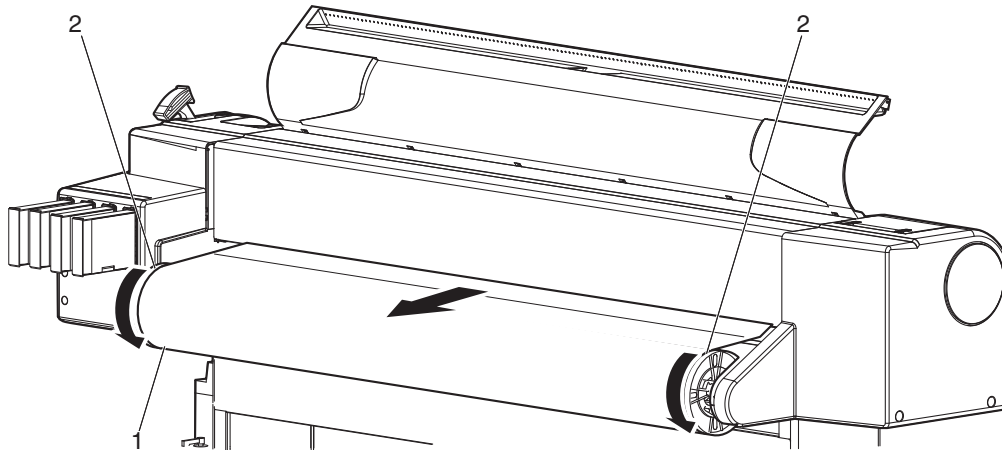

No.	Name
1	Roll media
2	Scroller

6. Pull the media loading lever towards the front.

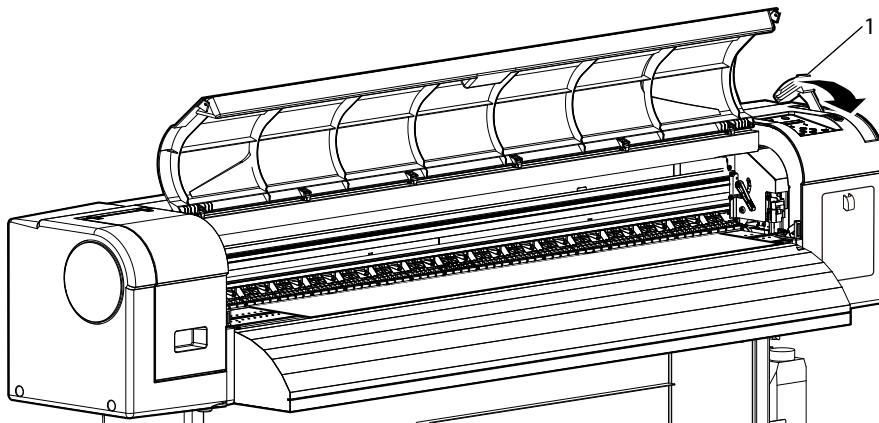

No.	Name
1	Media loading lever

NOTE

- When loading the new roll media, cut the leading edge of the media if it is not straight.

☞ [4.4.4 Cutting media](#)

7. Close the front cover.

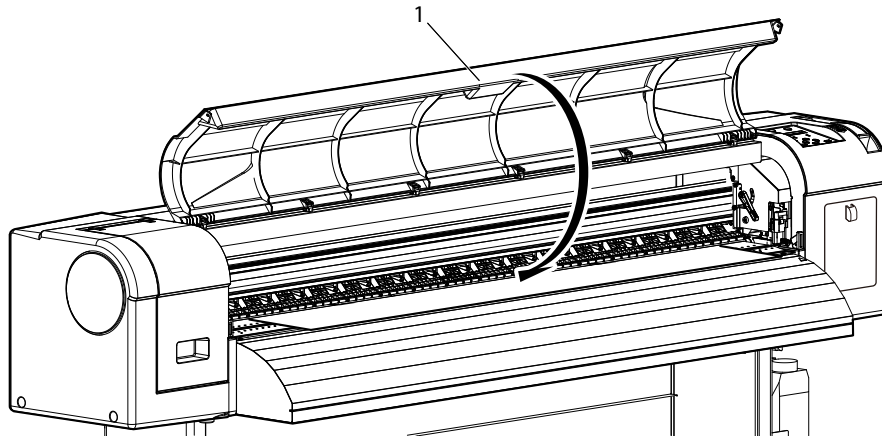

No.	Name
1	Front cover

- The User type setup menu is displayed on the operation panel.

TIP

To change the media type, follow “[3.4.4 Specifying the User Type Setting](#)” and set the media type.

3.4.3 Disabling Pressure Arms Individually

If thin media cockles while printing, try disabling some of the pressure arms. This may help to avoid cockling while printing.

Follow the procedure below to disable the pressure arms.

1. Push the media loading lever towards the back.

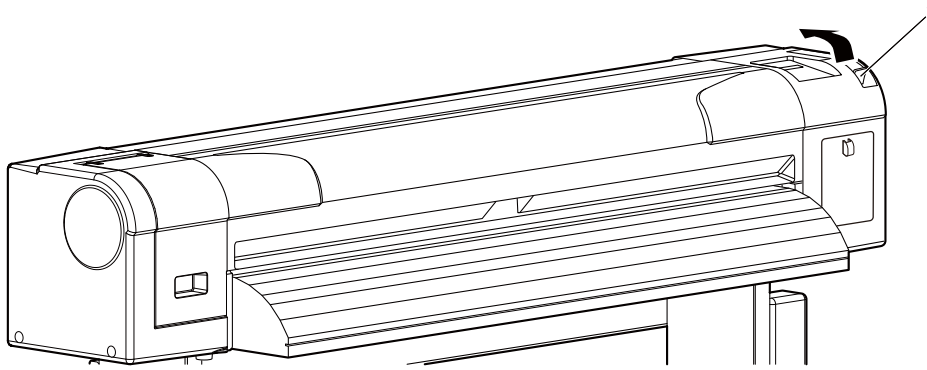

No.	Name
1	Media loading lever

2. Slide back the release switch of the pressure arms on both edges of the media.
 - Sliding the release switch back will disable the pressure on the pressure arms.

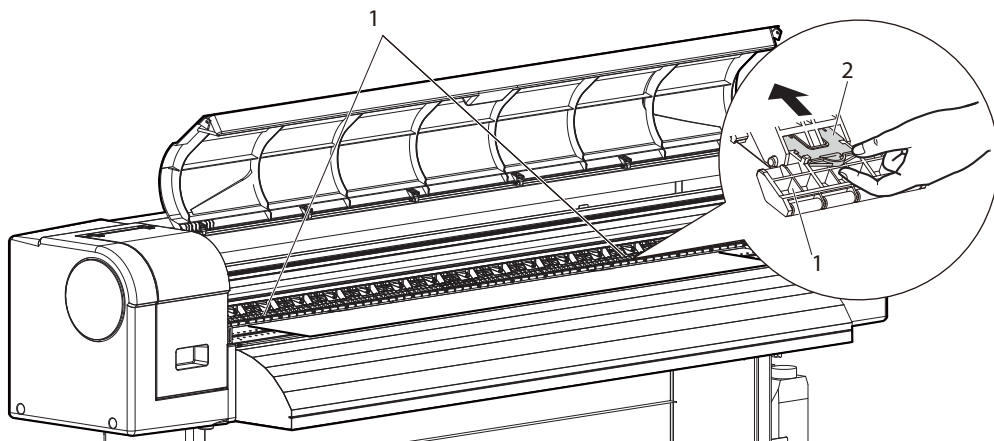

No.	Name
1	Pressure arms
2	Release switch

NOTE

- When releasing the function, make sure to release Pressure arms of both sides of the media as a set.

3. If media still gets cockling, try disabling more pressure arms.

NOTE

- The media may still get creases even when more Pressure arms are released.

3.4.4 Specifying the User Type Setting

This section explains how to set the user type setting.

Follow the procedure below to set the user type setting.

1. Turn ON the printer and load media.

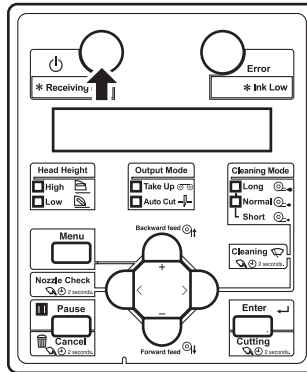

- After loading the media, the user type setting menu will appear.

TIP

Refer to the following for setting media.

[3.4.2 Loading a roll media into the printer](#)

2. Press the [+] key or [-] key to select the user type for the roll media loaded on the printer.

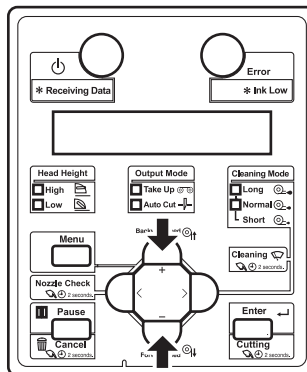

3. Press the [Enter] key on the operation panel.

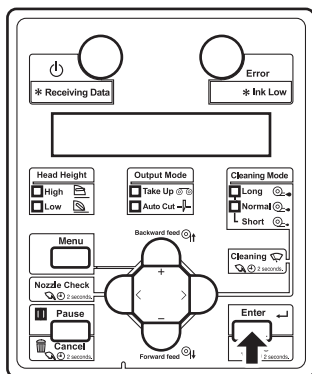

- The user type setting is set.
- “Media initial” is displayed on the operation panel and media initialization starts.

NOTE

If the following operations are performed in the user type setting menu, the printer starts media initial operation without specifying a user-defined setting.

- Pressing the [Cancel] key on the operation panel.
- No keys on the operation panel are pressed for 30 seconds.

- After media initial operation is complete, detected media width is displayed on the operation panel.
Press the [Enter] key on the operation panel and the display shifts to Normal.

4. When using the roll media, turn the scroller by hand to rewind the roll media and eliminate any warp.

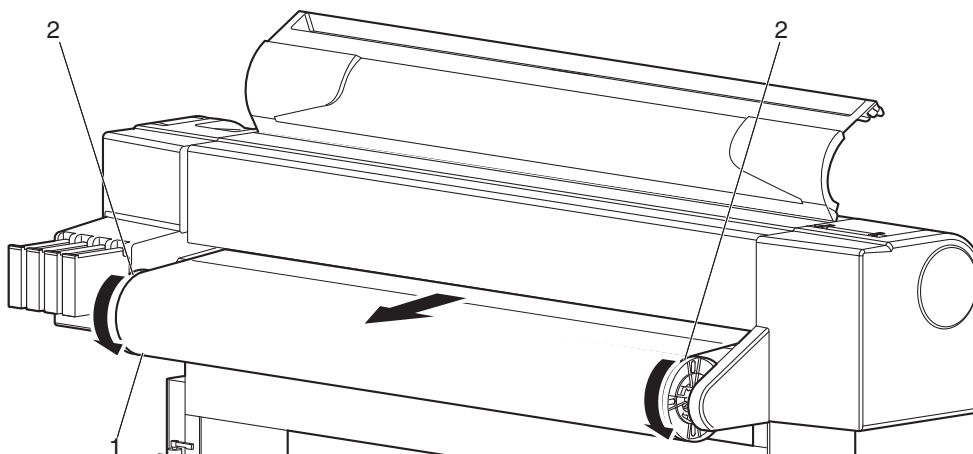

No.	Name
1	Roll media
2	Scroller

- Media set is complete.

3.5 Test print

Follow the procedure below to perform a test printing to confirm that the printer works correctly.

1. Turn ON the printer and load the media.
 - ☞ [3.4.2 Loading a roll media into the printer](#)
2. Check that "Ready to Print" is displayed on the operation panel.
3. Go to the Test Print menu on the operation panel.
 - a. Press the [Menu] key on the operation panel.

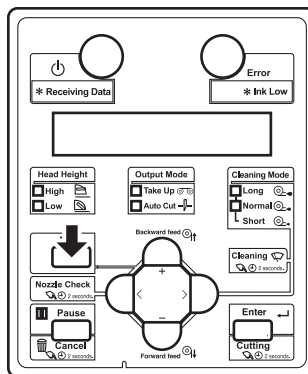

- “Menu 1: Setup>” is displayed on the operation panel.
 - The operation panel shifts to the Setup menu display.
- b. Press the [+] key or [-] key to select “Menu2: Test Print>”.

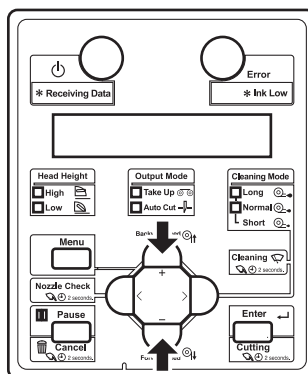

- c. Press the [>] key on the operation panel.

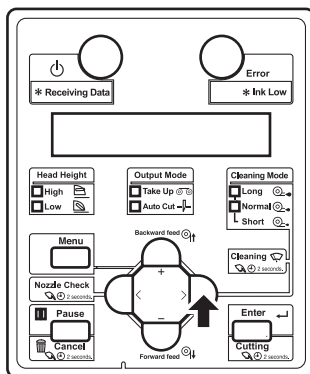

- “Test1: Nozzle Check” is displayed on the operation panel.
- The display shifts to the Test Print menu.

5.2 Test Print Menu

4. Press the [+] key or [-] key on the operation panel to select an item you want to print from the following options:

- Nozzle Check
- Nozzle Check F
- Mode Print
- Setup List
- Palette

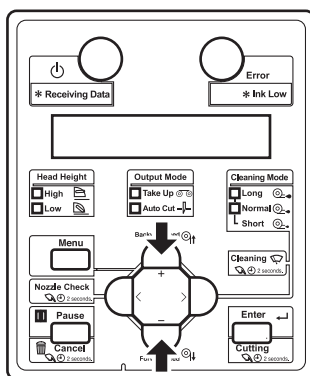

NOTE

When the selected print mode of the user type is Production, Palette menu is not displayed.

5.1.1.1.1 Print Mode menu

- Press the [Enter] key on the operation panel.

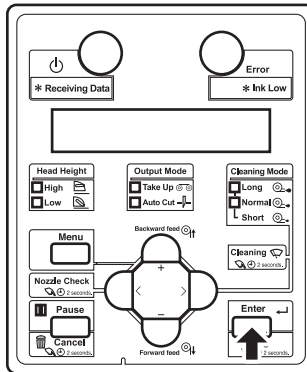

- The printer starts printing the selected item.

TIP

Refer to the following for details on each of the print list items.

☞ [3.5.1 Nozzle check](#) to [3.5.5 Palette print](#)

- To print different items, repeat step 4 to step 5.
- Press the [Cancel] key on the operation panel to exit from test print.

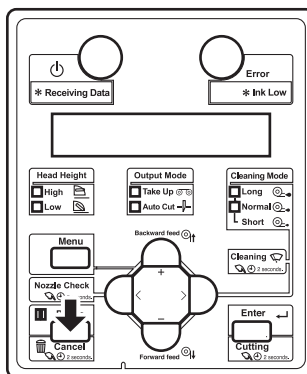

- "Ready to Print" is displayed on the operation panel.
- The procedure for test printing is complete.

3.5.1 Nozzle check

A nozzle check is a test print to verify whether there is no missing or faint line on the print due to nozzle clogging.

Print a nozzle check pattern selected from Nozzle setting menu.

 [5.1.24 Select Nozzle menu](#)

NOTE

- If any missing or faint line appears on the nozzle check print, perform head cleaning.

 [6.2.3 Head cleaning](#)

After the head cleaning, run a nozzle check again.

TIP

- Refer to the following for printing procedure.

 [3.5 Test print](#)

- A nozzle check pattern is printed with the printer information (date and time of printing, printer's serial number, firmware version, Select Nozzle setting).

OK

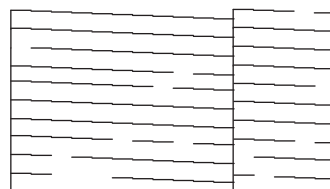
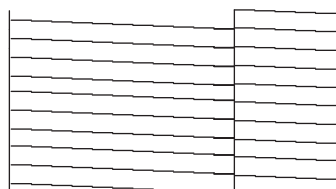

3.5.2 Nozzle check F

A nozzle check is a test print to verify whether there is no missing or faint line on the print due to nozzle clogging.

A nozzle check pattern is printed with all the nozzles on the print head.

NOTE

- If any missing or faint line appears on the nozzle check print, perform head cleaning.

➤ [6.2.3 Head cleaning](#)

After the head cleaning, run a nozzle check again.

TIP

- Refer to the following for printing procedure.

➤ [3.5 Test print](#)

- A nozzle check pattern is printed with the printer information (date and time of printing, printer's serial number, firmware version, Select Nozzle setting).

OK

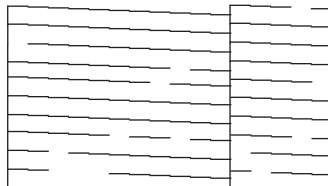
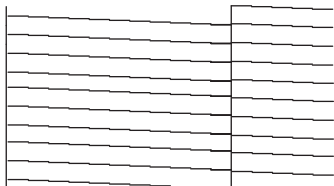

3.5.3 Mode print

This menu is used to confirm the following printer settings.

- Print Mode
- Effect
- Adjustment value

TIP

Refer to the following for printing procedure.

 [3.5 Test print](#)

2022/07/01 0:00 Quality/i-Screen/PF Adjust:0.00%



3.5.4 Setup print

This menu is used to check the current setup of the printer.

NOTE

- Keep the printed setup list at hand.

TIP

Refer to the following for printing procedure.

[3.5 Test print](#)

Setup List

<Information>		<Display> 2021/01/01 12:34	
SerialNo. = K15U00001	Total Print = 1000m	Language = English	
Model = XPJ-1341WR-P	Firmware = V1.00	Temperature = Celsius [C]	
Memory Size = 256MB		Length = mm	
<Menu Setup>		<Information>	
[Number]SelectMenu = Setup	Head Height:Low	Cleaning Mode:Normal	
[1]User Type = Type 1	[Number]SelectMenu = Setup	[19]IP Address = 192.168. 1.253	
[1]Print Mode = Quality (Effect = i-Screen)	[20]Subnet Mask = 255.255.255.0	[21]Gateway = 192.168. 1.254	
[2]Adjust Print	[22]Header Dump = Off	[23]Start Feed = 0.0mm	
[3]PF Adjust	[23]Initial Print	[24]Alert Buzzer = On	
[1]Auto	[3]Initial Change = 250.2/250mm	[25]Front Interface = Auto	
[2]Initial Print	[4]Confirm Print	[26]Select Nozzle	
[3]Micro Print	[5]Micro Print	[1]Print	
[6]Micro Change = -0.15%	[6]Micro Print	[2]Nozzle Settings = Nozzle ALL	
[4]Vacuum Fan = High	[4]Vacuum Fan = High		
[5]Thickness = 170um	[5]Thickness = 170um	<Ink Status>	
[6]User Copy	[6]User Copy	SmartChip KCMY 98/ 99/ 91/ 92	
[2]Splitting = On (Pass Count = 2Cnt)	[2]Splitting = On (Pass Count = 2Cnt)	<Life Times>	
[3]Side Margin = 5mm	[3]Side Margin = 5mm	Head : E*****F	
[4]Media Initial = Width	[4]Media Initial = Width	Pump : E*****F	
[5]Media Width = 1250mm	[5]Media Width = 1250mm	CR Motor : E*****F	
[6]Output Mode = Off (InkDryTimer= 0sec)	[6]Output Mode = Off (InkDryTimer= 0sec)	PF Motor : E*****F	
[7]Method of Cut = SingleCut-3steps (CutPressure=High)	[7]Method of Cut = SingleCut-3steps (CutPressure=High)	<SleepModeSettings>	
[8]Origin	[8]Origin	CleaningTimer = 6h	
[9]Prevent Stick	[9]Prevent Stick	<RollPaperRemain>	
[10]Standby Heating	[10]Standby Heating	[1]Print	
[11]Head Travel = Media	[11]Head Travel = Media	[2]Simple Print	
[12]Multi Strike = 1cnt	[12]Multi Strike = 1cnt	[3]Scan	
[13]Strike Wait = 0.0sec	[13]Strike Wait = 0.0sec	[4]Roll Length = Roll1 (Length = 30m)	
[14]Slant Check = On	[14]Slant Check = On	(PrintStop = On/NearEnd = 1m)	
[15]Auto Cleaning	[15]Auto Cleaning	[5]Auto Scan = Off	
Standby = 360min	Standby = 360min	[6]Auto Print = Off	
Printing = Off	Printing = Off		
Before Print = Off	Before Print = Off		
[16]Longstore	[16]Longstore		
[17]ICR Maintenance	[17]ICR Maintenance		
[18]Initialization	[18]Initialization		

<User Type List>

User Type	Type 1	Type 2	Type 3	Type 4	Type 5
Print Mode	Quality	High Quality	Quality	Production	High Speed
Print Mode>Effect	i-Screen	i-Screen	i-Screen	i-Screen	Fine&Fog
PF>Initial Adjust	250.2/250mm	250.2/250mm	250.2/250mm	250.2/250mm	499.7/500mm
PF>Micro Adjust	-0.15%	-0.15%	-0.15%	0.00%	0.10%
Vacuum Fan	High	High	High	Medium	Medium
Thickness	170um	170um	170um	170um	170um
User Type	Type 6	Type 7	Type 8	Type 9	Type10
Print Mode	Quality	Quality	Quality	Quality	Quality
Print Mode>Effect	i-Screen	i-Screen	i-Screen	i-Screen	i-Screen
PF>Initial Adjust	250.0/250mm	250.0/250mm	250.0/250mm	250.0/250mm	250.0/250mm
PF>Micro Adjust	0.00%	0.00%	0.00%	0.00%	0.00%
Vacuum Fan	High	High	High	High	High
Thickness	170um	170um	170um	170um	170um
User Type	Type11	Type12	Type13	Type14	Type15
Print Mode	Quality	Quality	Quality	Quality	Quality
Print Mode>Effect	i-Screen	i-Screen	i-Screen	i-Screen	i-Screen
PF>Initial Adjust	250.0/250mm	250.0/250mm	250.0/250mm	250.0/250mm	250.0/250mm
PF>Micro Adjust	0.00%	0.00%	0.00%	0.00%	0.00%
Vacuum Fan	High	High	High	High	High
Thickness	170um	170um	170um	170um	170um

3.5.5 Palette print

Palette print is executed for the color demonstration.

NOTE

When the selected print mode of the user type is Production, Palette menu is not displayed.

☞ [5.1.1.1.1 Print Mode menu](#)

TIP

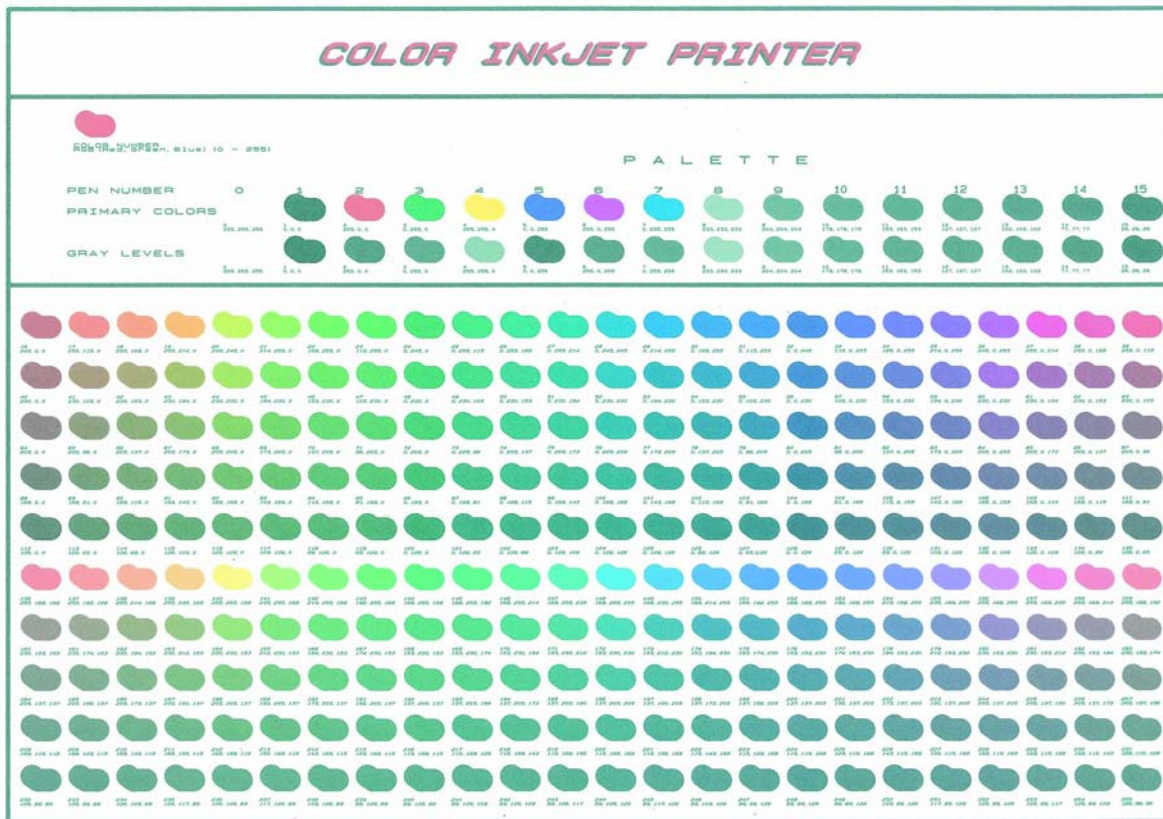

Refer to the following for printing procedure.

☞ [3.5 Test print](#)





3.6 Adjust Print

This menu allows you to calibrate the dot placement of bidirectional printing. The following three adjustment methods are available:

Adjustment method	Description	Reference
Auto	Perform an automatic calibration that the printer automatically prints and scans a pattern with the embedded color sensor to correct dot placement.	 3.6.1 Auto Adjust Print
Standard	Adjustment is performed only for the print mode set by the current user type. When the adjustment is done using this method, you must match the settings of print resolution, number of passes and printing direction in your RIP software with the current user type.	 3.6.2 Standard Adjust Print
Custom	You can also calibrate the dot placement of a print mode other than the one set in the current user mode. This allows you to print with an optimum image quality even if the print mode on the RIP is different from the one in the user type.	 3.6.3 Custom Adjustment Pattern

NOTE

- When newly setting or changing the user type setting after adjusting Standard adjust print, make sure to adjust print.
- If print defects (like banding or grainy look) still appear on the print, try an auto calibration again, or go to "Standard" or "Custom" to perform calibration.
 -  [3.6.2 Standard Adjust Print](#)
 -  [3.6.3 Custom Adjustment Pattern](#)
- When the print mode is changed after Standard adjust print, perform Standard adjust print again.
- Since all print modes are adjusted at once after performing Custom adjust print, adjust print is not required even after changing the print mode.
- When specifying a print mode for RIP software, etc, that is different from the mode set in the usertype setting, perform Custom head adjustment and check all patterns (A to F), and then adjust any patterns that are misaligned beforehand.
- "Adjust Print" requires at least 550 mm printable width. Before printing, make sure that there is sufficient width on the media.

If printable width is less than 550 mm, your printer will not perform printing. Printable width on the media can be adjusted by changing CR origin and side margin (left and right side margin) settings.

 -  [5.1.3 Side Margin menu](#), [5.1.5 Media Width menu](#), [5.1.8 Origin menu](#)

3.6.1 Auto Adjust Print

This menu performs an automatic adjustment using the embedded color sensor. It consists of the following menu options:

Menu Name	Description
All	Perform automatic adjustment for all patterns (A to F) using the color sensor.
Standard	Perform automatic adjustment for the currently selected print mode using the color sensor (calibrate the same print mode as "3.6.2 Standard Adjust Print").
Pattern A to F	Choose the adjustment pattern between A and F for automatic adjustment.

Follow the procedure below to adjust print quality.

1. Turn ON the printer and load the roll media.
 - ↳ [3.4.2 Loading a roll media into the printer](#)
2. Go to the Adjust Print menu on the operation panel.
 - a. Press the [Menu] key on the operation panel.

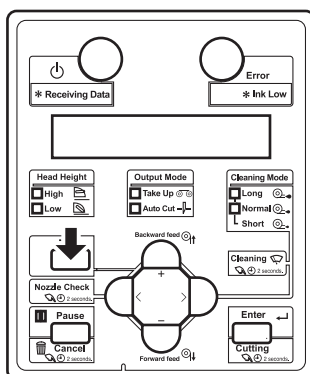

- “Menu1: Setup>” is displayed on the operation panel.
- b. Press the [>] key on the operation panel.

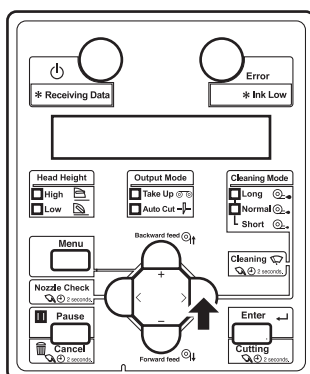

- “Set1: User Type” is displayed on the operation panel.

- c. Press the [Enter] key on the operation panel.

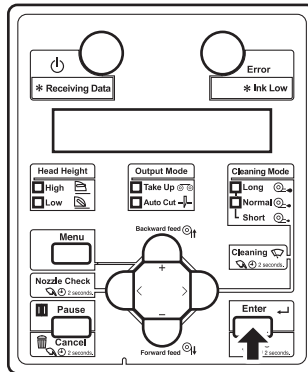

- “User: TypeXX” (XX is a number between 1 and 15) is displayed on the operation panel.
- d. Press the [+] key or [-] key on operation panel to select the user type setting.

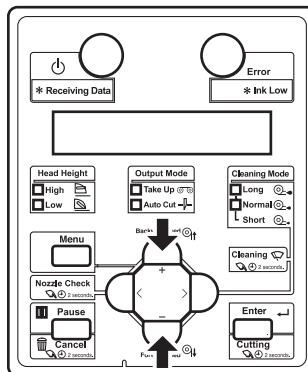

- e. Press the [Enter] key on the operation panel.

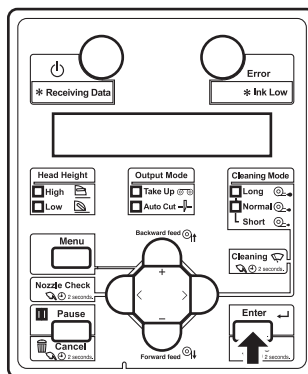

- “**>1: Print Mode” is displayed on the operation panel.

- f. Press the [+] key or [-] key to select “**>2: Adjust Print>”.

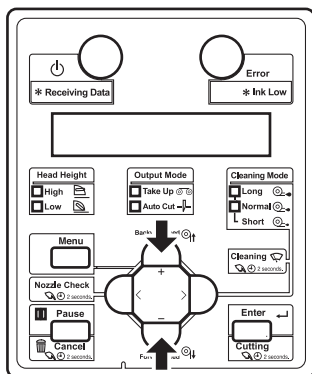

- g. Press the [>] key on the operation panel.

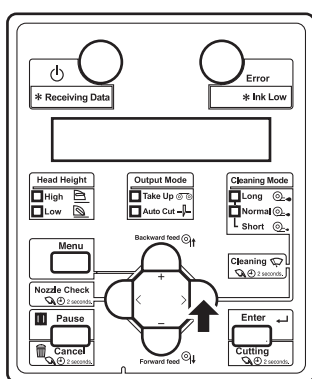

- “Thickness 170 μm” is displayed on the operation panel. (The default is set to 170 μm. If the default value has been changed, the changed value is displayed.)

- h. Press the [+] key or [-] key and enter the thickness of the paper in the range of 80 μm to 1,300 μm.

- This setting is the same as “Media thickness menu”.

[5.1.1.1.6 Media thickness menu](#)

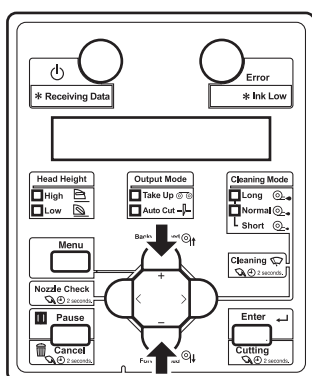

- i. Press the [Enter] key on the operation panel.

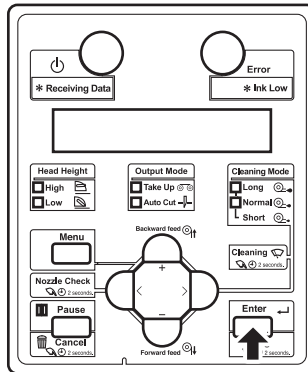

- Media thickness value is set.
 - “Adj.Print1: Auto” is displayed on the operation panel.
- j. Press the [Enter] key on operation panel.

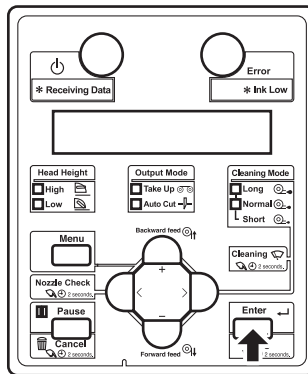

- “Auto1: All” is displayed on the operation panel.
- The display enters the Adjust Print menu.

5.1.1.1.3 Adjust Print menu

- k. Press the [+] key or [-] key and select the adjustment pattern from "ALL", "Standard", or any specific pattern between "Adjust Pattern A" and "Adjust Pattern F".

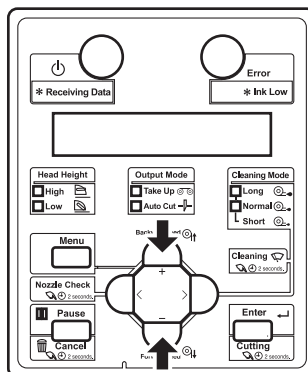

- Press the [Enter] key on the operation panel.

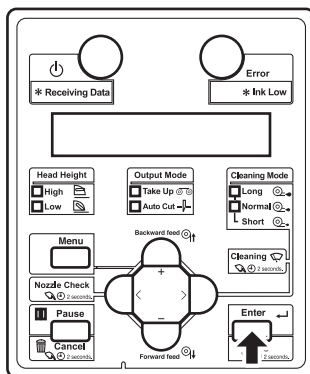

- “A confirmation pattern for print quality adjustment is printed.
- The printer scans the print using the embedded color sensor, then automatically corrects the dot placement.
 - Once successfully completed, the message “Auto Adjust Succeeded” will appear on the panel.
 - If failed, the message “Auto Adjust Failed” will appear on the panel.
 - Press the [Enter] key on the operation panel.

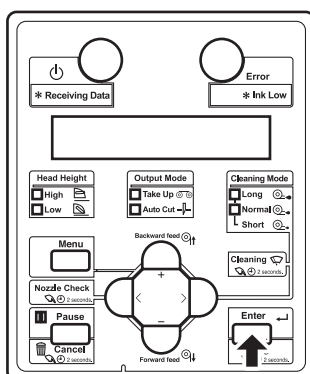

- The display goes back to the Adjust Print menu.

NOTE



- If failed in the middle of the calibration, the adjustment value for the pattern which has been successfully calibrated will be saved in the printer, but the adjustment value for the pattern which has been failed to calibrate or has not been calibrated yet will not be saved in the printer.
- If print defects (like banding or grainy look) still appear on the print, try an auto calibration again, or go to "Standard" or "Custom" to perform calibration.

👉 [3.6.2 Standard Adjust Print](#)



👉 [3.6.3 Custom Adjustment Pattern](#)

3.6.2 Standard Adjust Print

Adjusts only the print mode in the user type setting which is currently set.
It consists of the following menu options:

Menu Name	Description	Reference
Standard Confirmation Pattern	Print the confirmation pattern and check the amount of misalignment.	 3.6.2.1 Standard Confirmation Pattern
Standard Rough Adjustment Pattern	Perform this adjustment when the misalignment is large.	 3.6.2.2 Standard Rough Adjustment Pattern
Standard Micro Adjustment Pattern	Perform this adjustment when the misalignment is small.	 3.6.2.3 Standard Micro Adjustment Pattern

Follow the procedure below to adjust print quality.

1. Print the confirmation pattern and check the amount of misalignment.
 [3.6.2.1 Standard Confirmation Pattern](#)
2. Perform rough adjustment when the misalignment is large.
 [3.6.2.2 Standard Rough Adjustment Pattern](#)
Perform micro adjustment when the misalignment is small.
 [3.6.2.3 Standard Micro Adjustment Pattern](#)

NOTE

- Perform rough adjustment first when the degree of misalignment is difficult to determine.

3. Print the confirmation pattern and check if the printer is adjusted properly.
 [3.6.2.1 Standard Confirmation Pattern](#)
4. If the printer is not adjusted, go back to Step 2.

NOTE

- When you are not satisfied with the result of rough adjustment, perform micro adjustment.

3.6.2.1 Standard Confirmation Pattern

Print the confirmation pattern for the print mode in the user type setting which is currently set.

1. Turn ON the printer and load the roll media.
 -  [3.4.2 Loading a roll media into the printer](#)
2. Go to the Adjust Print menu on the operation panel.
 - a. Press the [Menu] key on the operation panel.

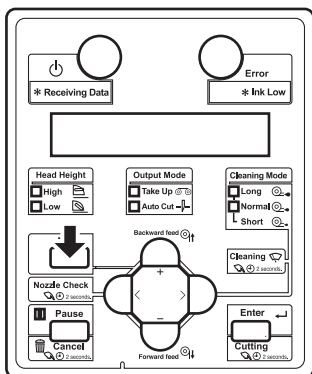

- “Menu1: Setup>” is displayed on the operation panel.
- b. Press the [>] key on the operation panel.

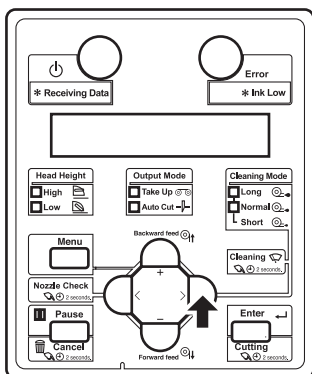

- “Set1: User Type” is displayed on the operation panel.

- c. Press the [Enter] key on the operation panel.

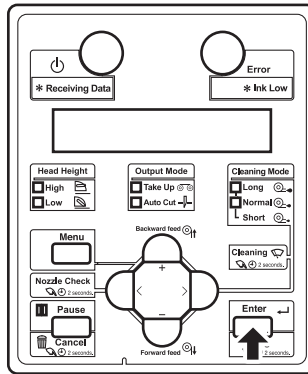

- “User: TypeXX” (XX is a number between 1 and 15) is displayed on the operation panel.

- d. Press the [+] key or [-] key on operation panel to select the user type setting.

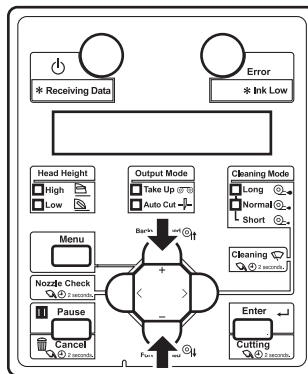

- e. Press the [Enter] key on the operation panel.

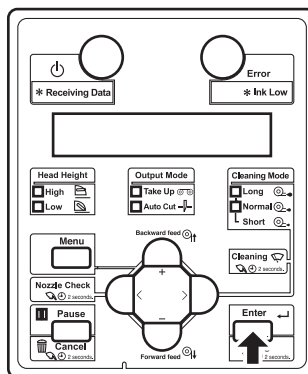

- “**>1: Print Mode” is displayed on the operation panel.

- f. Press the [+] key or [-] key to select “**>2: Adjust Print>”.

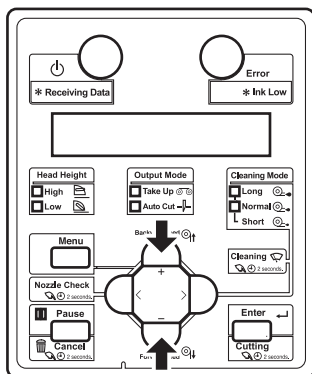

- g. Press the [>] key on the operation panel.

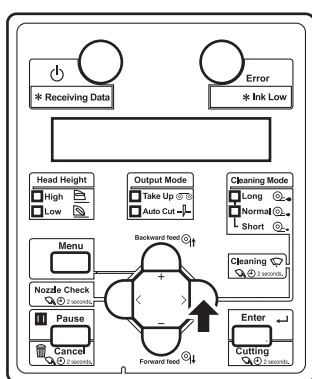

- “Thickness 170 μm” is displayed on the operation panel. (The default is set to 170 μm. If the default value has been changed, the changed value is displayed.)

- h. Press the [+] key or [-] key and enter the thickness of the paper in the range of 80 μm to 1,300 μm.

- This setting is the same as “Media thickness menu”.

 [5.1.1.1.6 Media thickness menu](#)

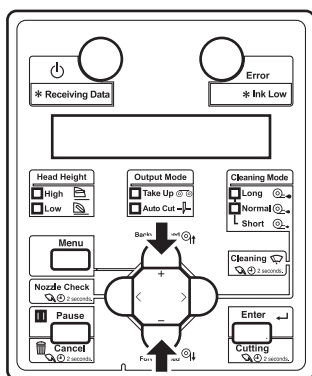

- i. Press the [Enter] key on the operation panel.

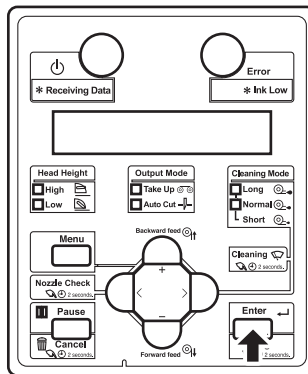

- Media thickness value is set.
 - “Adj.Print1: Auto” is displayed on the operation panel.
- j. Press the [+] key or [-] key to select “Adj.Print2: Standard”.

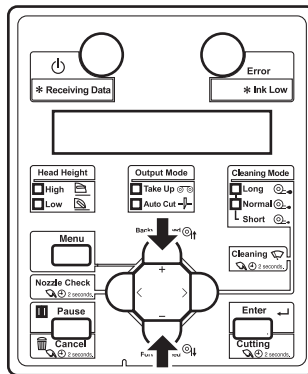

- k. Press the [Enter] key on the operation panel.

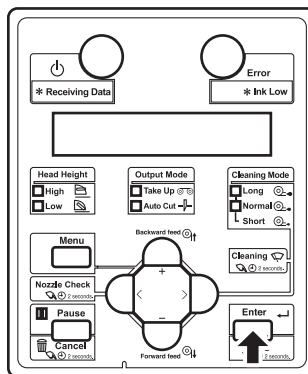

- “Adj.1: Confirm Ptn.” is displayed on the operation panel.
- The display enters the Adjust Print menu.

5.1.1.1.3 Adjust Print menu

3. Press the [Enter] key on the operation panel.

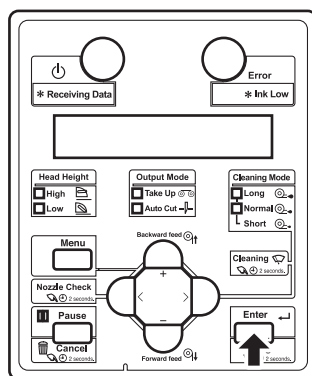

- A confirmation pattern for print quality adjustment is printed.

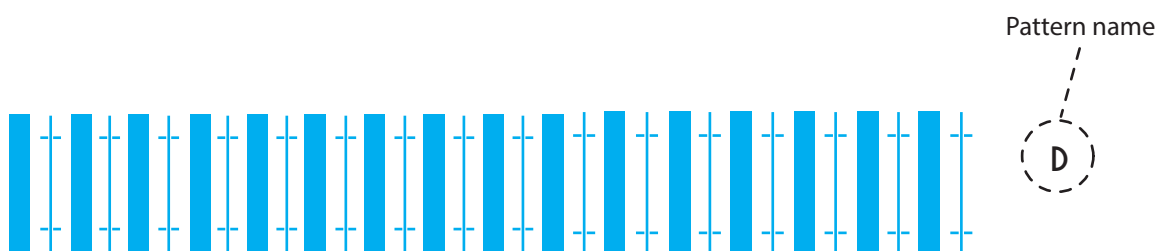

- After the confirmation pattern is printed, operation panel returns to “Adj. 1: Confirm Ptn”.

4. Confirm that the confirmation pattern printing result is as follows.

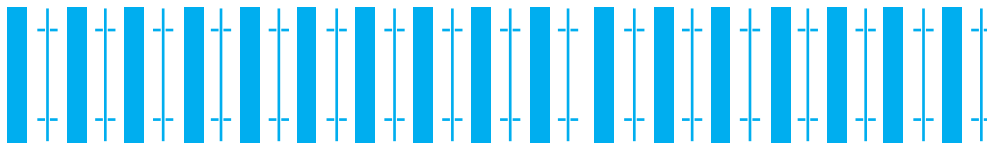
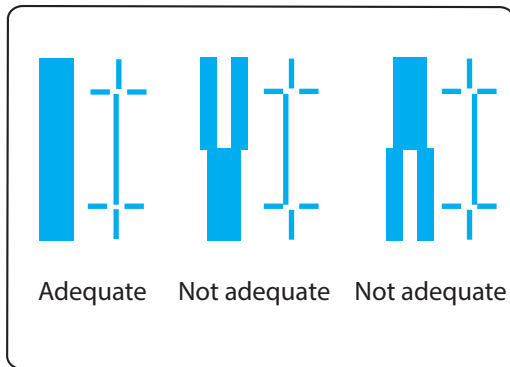

D

- a. When the printing result is Adequate;
 - You do not need perform print quality adjustment.
 - The procedure for print quality adjustment is complete.
- b. When the printing result is Not adequate;
 - You need to perform print quality adjustment.
 - Perform rough adjustment when the misalignment is large.
 ☞ [3.6.2.2 Standard Rough Adjustment Pattern](#)
 - Perform micro adjustment when the misalignment is small.
 ☞ [3.6.2.3 Standard Micro Adjustment Pattern](#)

3.6.2.2 Standard Rough Adjustment Pattern

Perform rough adjustment when the degree of misalignment is large.
Print rough adjustment pattern and register the set values.

1. Go to the Standard Adjust Print menu on operation panel in the same way as step 2 of “3.6.2.1 Standard Confirmation Pattern”.
2. Press the [+] key or [-] key to select “Adj.2: Rough Pattern”.

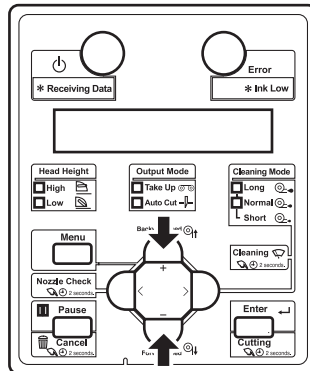

3. Press the [Enter] key on the operation panel.

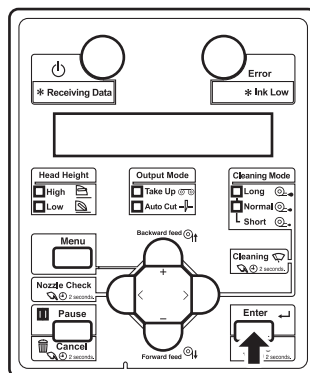

- A rough adjustment pattern is printed.

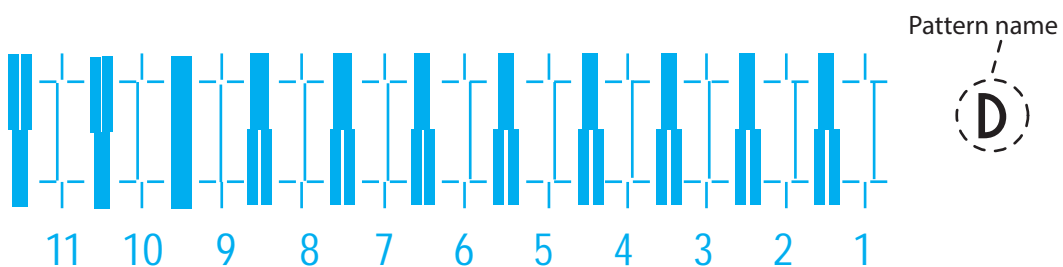

- For the rough adjustment pattern, the same patterns will be printed on both sides and center of the media.

4. Check the both ends and the center of the print result that printed with Adjust pattern, and select the number from 1 to 11 that is not out of alignment.
- “9” is selected in the next printing sample.

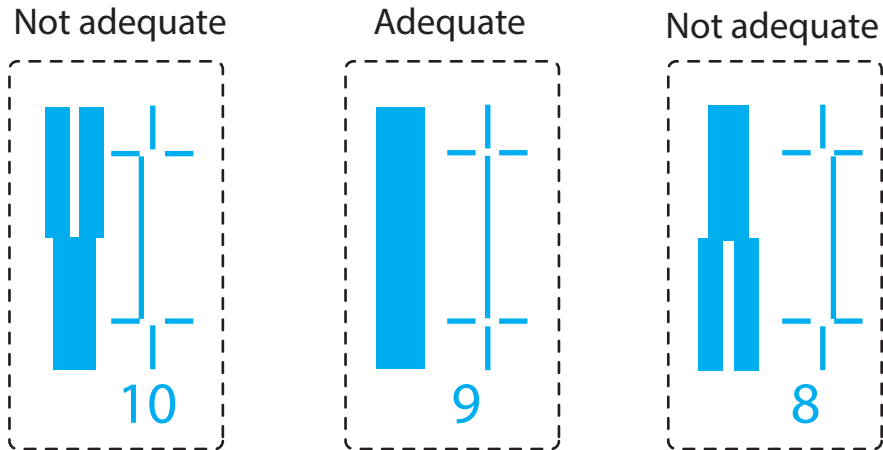
**NOTE**

- “6” is the current setting value.
- When the line is aligned, the bold line on its left side does not have a white vertical line in the middle.

- “Pattern *: 6” (* indicates a pattern name as shown below) is displayed on the operation panel.
- The print modes and their pattern names are as follows.

PrintMode	PatternName
High Quality	D
Quality	D
Production	D
High Speed	D

NOTE

- Refer to the following for Print mode.
[👉 5.1.1.1.1 Print Mode menu](#)

5. Press the [+] key or [-] key to enter the number that you selected in Step 4.

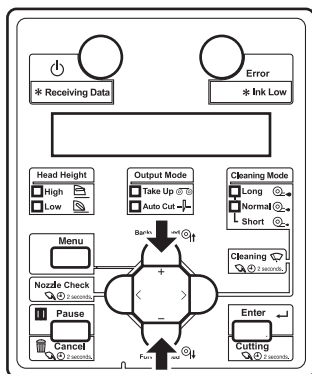

NOTE

- When you press the [Cancel] key, the input operation is not executed and “Adj.2: Rough Pattern” is displayed on the operation panel.

6. Press the [Enter] key on the operation panel.

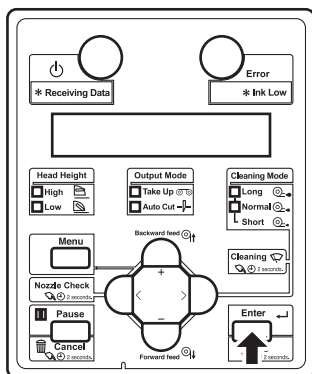

- Determines the setting.
- “Adj.2: Rough Pattern” is displayed on operation panel.

3.6.2.3 Standard Micro Adjustment Pattern

Perform micro adjustment when the degree of misalignment is small.
Print micro adjustment pattern and register the set values.

1. Go to the Standard Adjust Print menu on operation panel in the same way as step 2 of “3.6.2.1 Standard Confirmation Pattern”.
2. Press the [+] key or [-] key to select “Adj.3: Fine Pattern”.

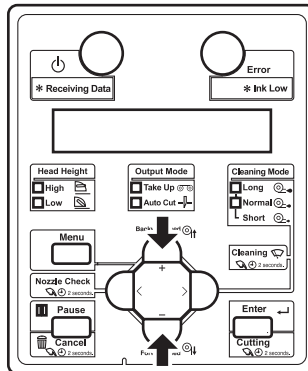

3. Press the [Enter] key on the operation panel.

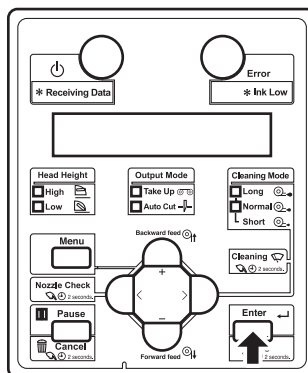

- An micro adjust print pattern is printed.

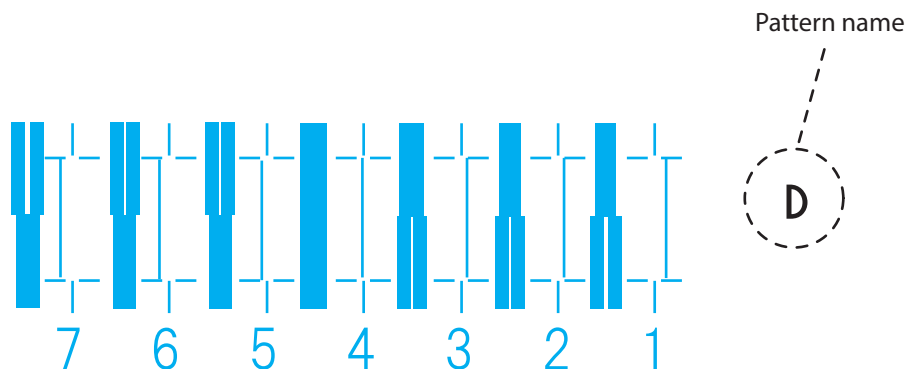

- For the micro adjustment pattern, the same patterns will be printed on both sides and center of the media.

4. Check the both ends and the center of the print result that printed with Adjust pattern, and select the number from 1 to 7 that is not out of alignment.
 - “6” is selected in the next printing sample.

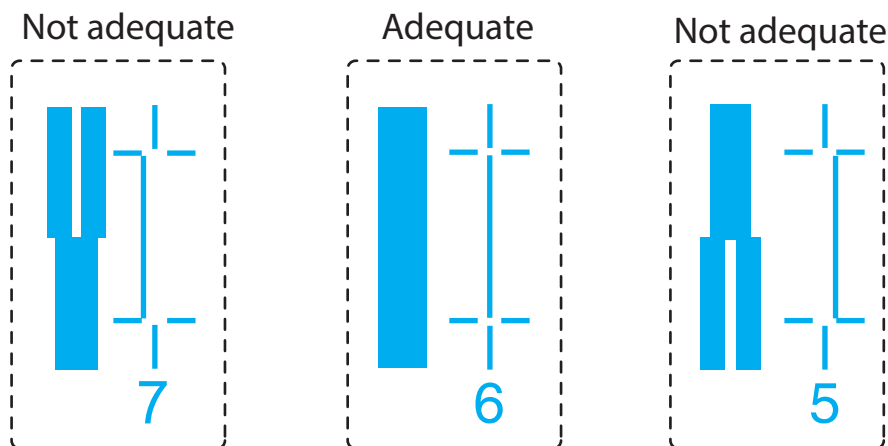

NOTE

- “4” is the current setting value.
- When the line is aligned, the bold line on its left side does not have a white vertical line in the middle.

- “Pattern *: 4” (* indicates a pattern name as shown below) is displayed on the operation panel.
- The print modes and their pattern names are as follows.

PrintMode	PatternName
High Quality	D
Quality	D
Production	D
High Speed	D

NOTE

- Refer to the following for Print mode.
 📖 [5.1.1.1.1 Print Mode menu](#)

- Press the [+] key or [-] key to enter the number that you selected in Step 4.

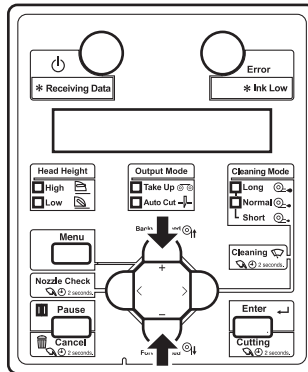

NOTE

- When you press the [Cancel] key on operation panel, the display returns to “Adj.3: Fine Pattern”.

- Press the [Enter] key on the operation panel.

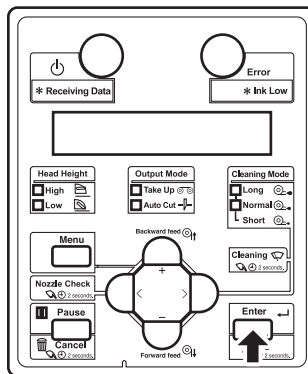





- Determines the setting.
- “Adj.3: Fine Pattern” is displayed on operation panel.

3.6.3 Custom Adjustment Pattern

Perform adjustment for all patterns (A to F).

All print modes will be adjusted.

This menu consists of the following menus.

Menu Name		Description	Reference
Custom confirmation pattern		Print out the confirmation patterns (A to F) and check the degree of misalignment.	 3.6.3.1 Custom Confirmation Pattern
Custom rough adjustment pattern	Rough PatternALL	Perform this when the degree of misalignment is large. All confirmation patterns (A to F) will be adjusted.	 3.6.3.2.1 Rough Pattern ALL
	Individual Rough Adj. pattern	Perform this when the degree of misalignment is large. One of the confirmation patterns (A to F) will be adjusted.	 3.6.3.2.2 Rough Pattern A to F
Custom micro adjustment pattern	Adj. PatternALL	Perform this when the degree of misalignment is small. All confirmation patterns (A to F) will be adjusted.	 3.6.3.3.1 Fine Pattern ALL
	Individual Adj. pattern	Perform this when the degree of misalignment is small. One of the confirmation patterns (A to F) will be adjusted.	 3.6.3.3.2 Fine Pattern A to F

Follow the procedure below to adjust print quality.

1. Print the confirmation pattern and check the amount of misalignment.

 [3.6.3.1 Custom Confirmation Pattern](#)

2. Perform rough adjustment when the misalignment is large.

 [3.6.3.2 Custom Rough Adjustment Pattern](#)

Perform micro adjustment when the misalignment is small.

 [3.6.3.3 Custom Micro Adjustment Pattern](#)

NOTE

- Perform rough adjustment first when the degree of misalignment is difficult to determine.
- Perform adjustment for A to F patterns if they are misaligned.

3. Print the confirmation pattern and check if the printer is adjusted properly.

 [3.6.3.1 Custom Confirmation Pattern](#)

4. If the printer is not adjusted, go back to Step 2.

NOTE

- Perform micro adjustment if the printer is not fully adjusted after rough adjustment.
- In adjustment patterns, there are Adjust pattern ALL where all patterns will be adjusted and Individual Adj. pattern where the patterns A to F can be adjusted individually.

☞ [3.6.3.3.1 Fine Pattern ALL](#)

☞ [3.6.3.3.2 Fine Pattern A to F](#)

3.6.3.1 Custom Confirmation Pattern

Using this menu, you can print out all of the confirmation patterns (A to F) and check the degree of misalignment.

1. Turn ON the printer and load the roll media.
 - ☞ [3.4.2 Loading a roll media into the printer](#)
2. Go to the Adjust Print menu on the operation panel.
 - a. Press the [Menu] key on the operation panel.

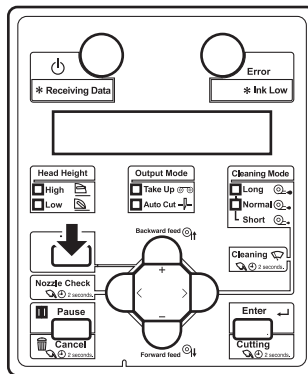

- “Menu1: Setup>” is displayed on the operation panel.

b. Press the [>] key on the operation panel.

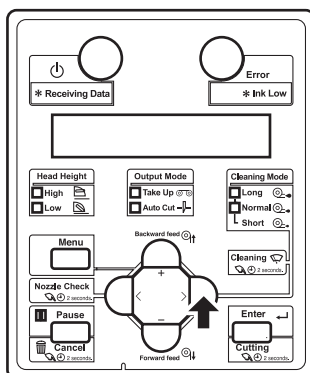

- “Set1: User Type” is displayed on the operation panel.

c. Press the [Enter] key on the operation panel.

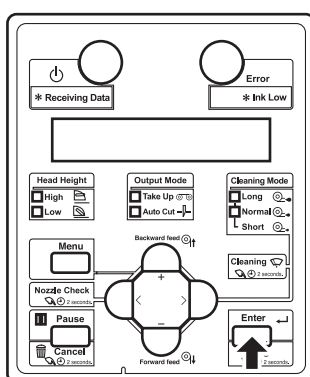

- “User: TypeXX” (XX is a number between 1 and 15) is displayed on the operation panel.

d. Press the [+] key or [-] key on operation panel to select the user type setting.

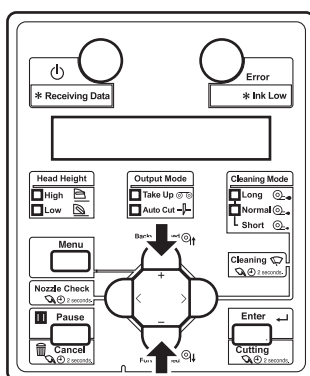

- e. Press the [Enter] key on the operation panel.

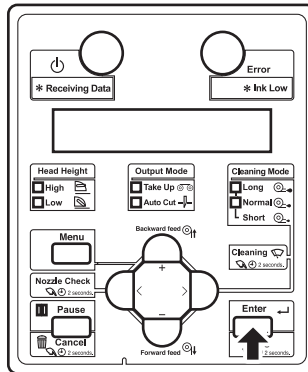

- “**>1: Print Mode” is displayed on the operation panel.
- f. Press the [+] key or [-] key to select “**>2: Adjust Print>”.

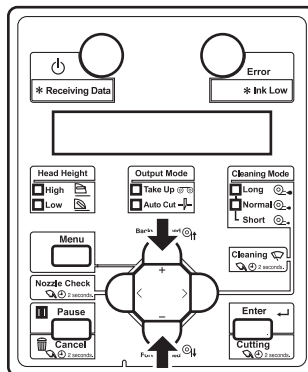

- g. Press the [>] key on the operation panel.

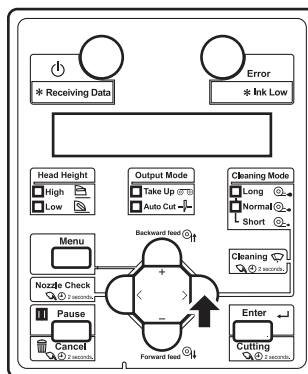

- “Thickness 170 μm” is displayed on the operation panel. (The default is set to 170 μm. If the default value has been changed, the changed value is displayed.)

- h. Press the [+] key or [-] key and enter the thickness of the paper in the range of 80 μm to 1,300 μm .
- This setting is the same as “Media thickness menu”.
 [5.1.1.1.6 Media thickness menu](#)

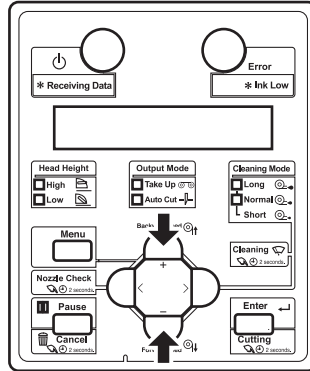

- i. Press the [Enter] key on the operation panel.

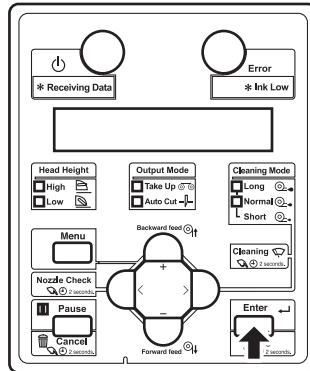

- Media thickness value is set.
 - “Adj.Print1: Auto” is displayed on the operation panel.
- j. Press the [+] key or [-] key to select “Adj.Print3: Custom”.

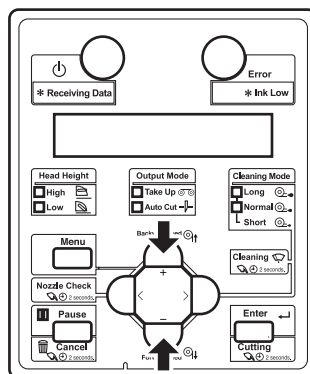

- k. Press the [Enter] key on the operation panel.

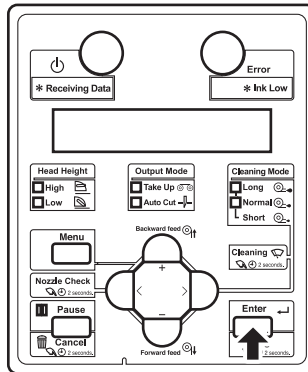

- “Adj.1: Confirm Ptn.” is displayed on the operation panel.
- The display enters the Adjust Print menu.

5.1.1.1.3 Adjust Print menu

3. Press the [Enter] key on the operation panel.

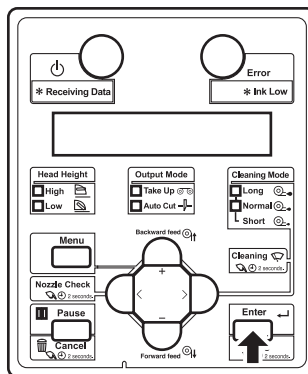

- A confirmation pattern for print quality adjustment is printed.
- Six confirmation patterns of A to F will be printed.

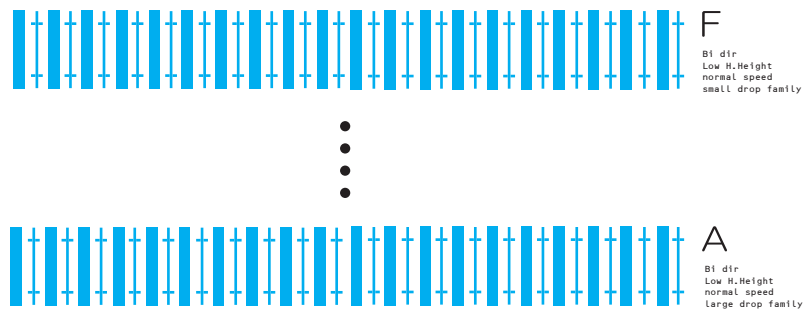

- After the confirmation pattern is printed, operation panel returns to “Adj.1: Confirm Ptn.”

4. Confirm that the confirmation pattern printing result is as follows.

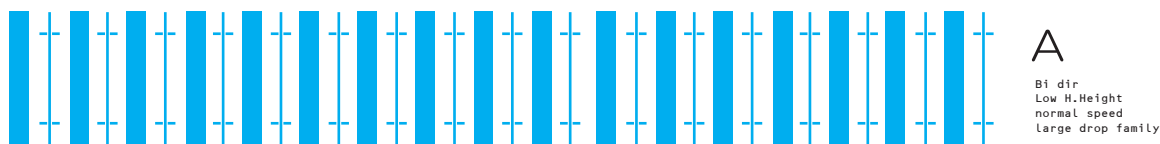
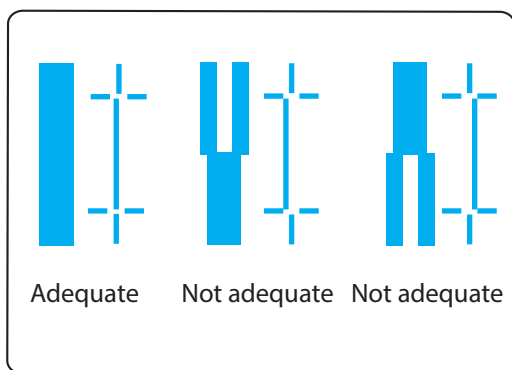

- Check each of the confirmation patterns A to F.



- When the printing result is Adequate;
 - You do not need perform print quality adjustment.
 - The procedure for print quality adjustment is complete.
- When the printing result is Not adequate;
 - You need to perform print quality adjustment.
 - Perform rough adjustment when the misalignment is large.
 - ☞ [3.6.3.2 Custom Rough Adjustment Pattern](#)
 - Perform micro adjustment when the misalignment is small.
 - When all patterns A to F require adjustment: ☞ [3.6.3.3.1 Fine Pattern ALL](#)
 - When any pattern of A to F requires adjustment: ☞ [3.6.3.3.2 Fine Pattern A to F](#)

3.6.3.2 Custom Rough Adjustment Pattern

Perform micro adjustment when the degree of misalignment is large.
This menu consists of the following menus.

Menu name		Description	Reference
Custom rough adjustment pattern	Rough Pattern ALL	All confirmation patterns (A to F) will be adjusted.	 3.6.3.2.1 Rough Pattern ALL
	Rough Pattern A to F	One of the confirmation patterns (A to F) will be adjusted.	 3.6.3.2.2 Rough Pattern A to F

3.6.3.2.1 Rough Pattern ALL

- Go to the Custom Adjust Print menu on operation panel in the same way as Step 2 of “[3.6.3.1 Custom Confirmation Pattern](#)”.
- Press the [+] key or [-] key on operation panel to select “Adj:2: RoughPtn. ALL”.

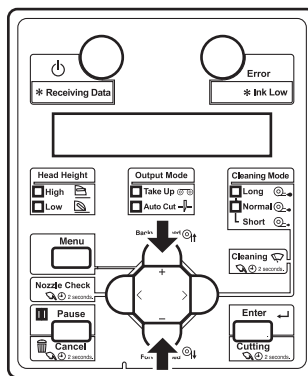

- Press the [Enter] key on operation panel.

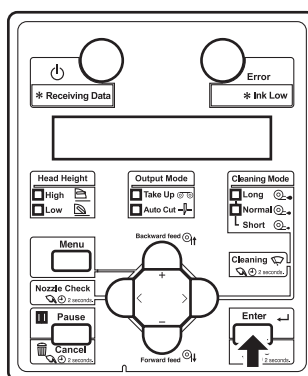

- Starts a rough adjustment pattern printing.

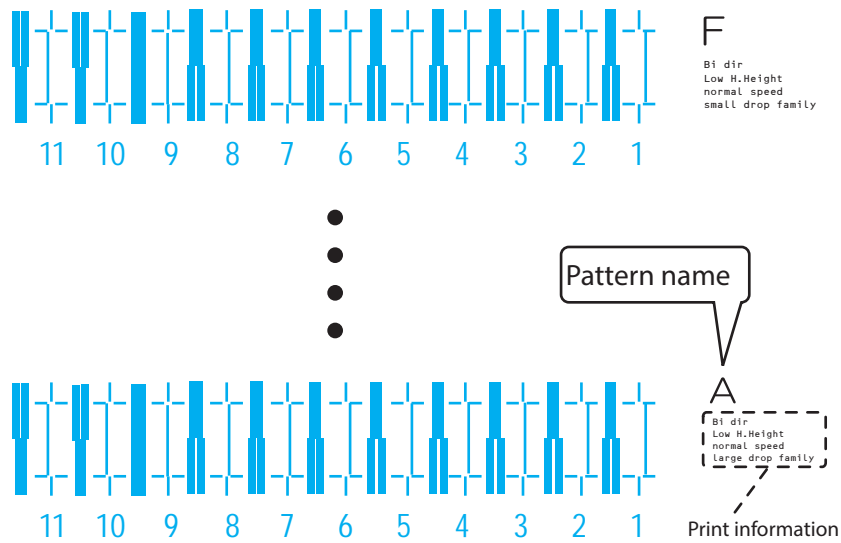

- For the rough adjustment pattern, the same patterns will be printed on both sides and center of the media.
 - 6 rough adjustment patterns (A to F) are printed. Enter the adjusted values.
4. Check the both ends and the center of the print result that printed with Adjust pattern, and select the number from 1 to 11 that is not out of alignment.
- “9” is selected in the following pattern.

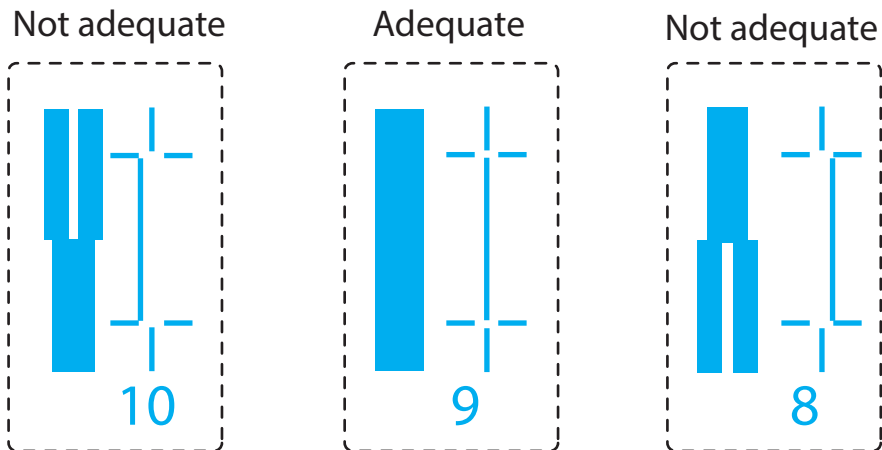

NOTE

- “6” is the current setting value.
- When the line is aligned, the bold line on its left side does not have a white vertical line in the middle.

- “PatternA: 6” is displayed on the operation panel.

5. Press the [+] key or [-] key to enter the number that you selected in Step 4.

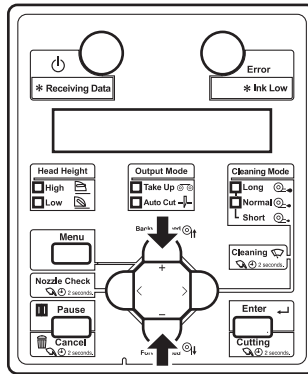

NOTE

- When you press the [Cancel] key on operation panel, the setting value is not entered and the display returns to “Adj.2: RoughPtn. ALL”.

6. Press the [Enter] key on the operation panel.

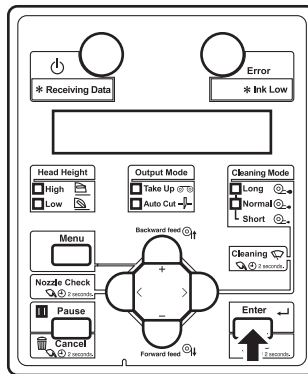

- Determines the setting.

7. Enter the values for patterns B to F in the same way.

- Press the [Enter] key to set the values.
- Once all set values have been entered, press the [Enter] key to register the set values of “Pattern A” to “Pattern F” to the printer.
- “Adj.2: RoughPtn. ALL” is displayed on operation panel.

3.6.3.2.2 Rough Pattern A to F

Print one adjustment pattern from A to F and register the set value.
The following describes how to adjust pattern A only.

1. Go to the Custom Adjust Print menu on operation panel in the same way as Step 2 of [3.6.3.1 Custom Confirmation Pattern](#).
2. Press the [+] key or [-] key on operation panel to select “Adj.3: RoughPattern A”.

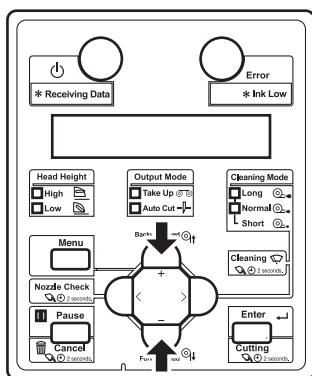

3. Press the [Enter] key on operation panel.

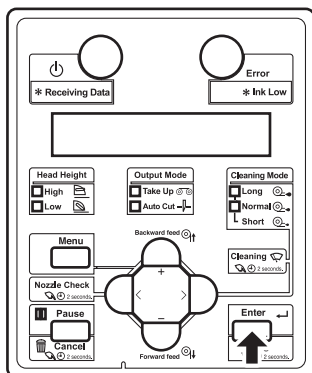

- A rough adjust print pattern is printed.

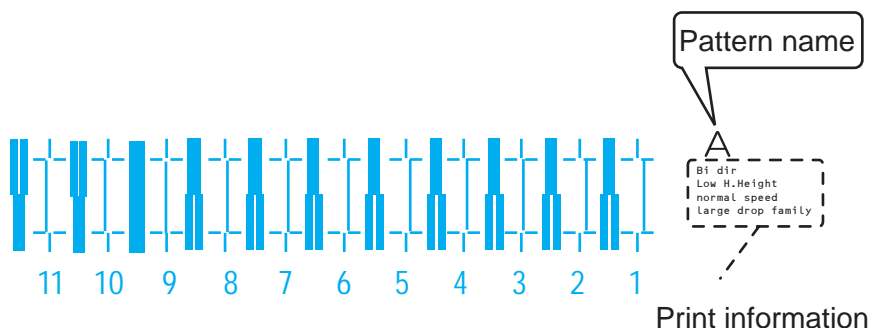

- For the Adjust print pattern, the same patterns will be printed repeatedly on both sides and center of the media.

4. Check the print results on both sides and center of the media and select the number that looks most aligned between 1 and 11.
- “9” is selected in the next printing sample.

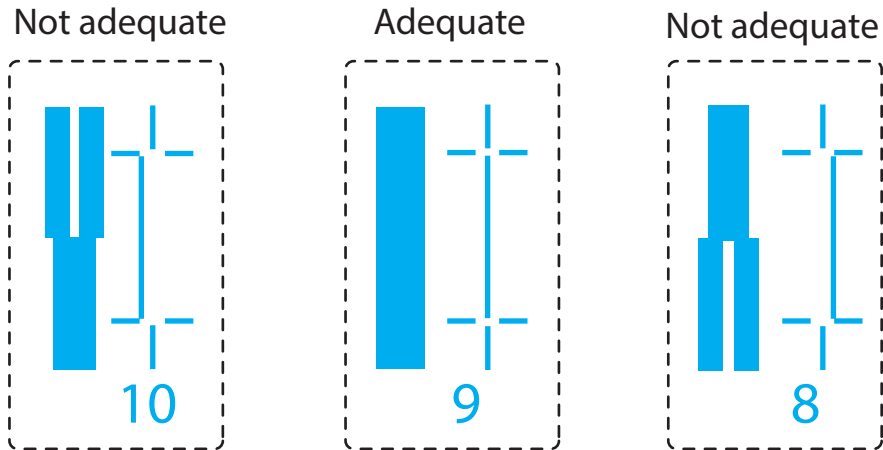
**NOTE**

- “6” represents the current setting value.
- When the line is aligned, the bold line on its left side does not have a white vertical line.

- “PatternA: 6” is displayed on operation panel.

5. Press the [+] key or [-] key on operation panel to enter the number that you selected in Step 4.

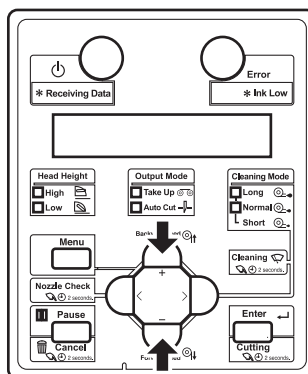
**NOTE**

- When you press the [Cancel] key on operation panel, the display returns to “Adj.3: RoughPatternA”.

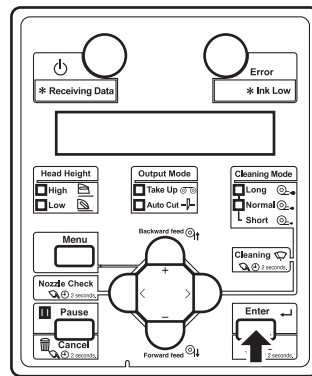

6. Press the [Enter] key on operation panel.



- Determines the setting.
- "Adj.3: RoughPatternA" is displayed on operation panel.

3.6.3.3 Custom Micro Adjustment Pattern

Perform micro adjustment when the degree of misalignment is small.
This menu consists of the following menus.

Menu Name		Description	Reference
Custom Micro Adjustment Pattern	Fine PatternALL	All confirmation patterns (A to F) will be adjusted.	 3.6.3.3.1 Fine Pattern ALL
	Fine Pattern A to F	One of the confirmation patterns (A to F) will be adjusted.	 3.6.3.3.2 Fine Pattern A to F

3.6.3.3.1 Fine Pattern ALL

Print micro adjustment pattern ALL and register the set values.

- Go to the Custom Adjust Print menu on the operation panel in the same way as in step 2 of “[3.6.3.1 Custom Confirmation Pattern](#)”.
- Press the [+] key or [-] key on operation panel to select “Adj.9: Fine Ptn. ALL”.

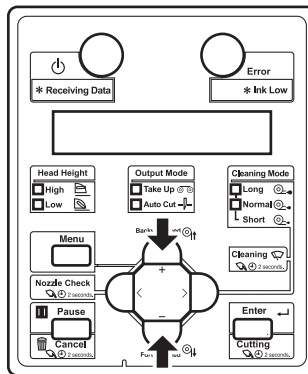

- Press the [Enter] key on the operation panel.

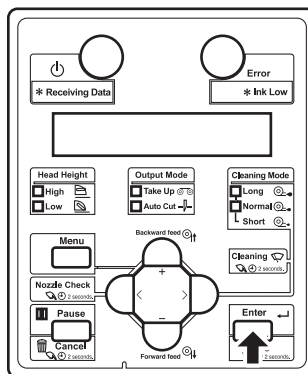

- An adjust print pattern is printed.
For Adjust print pattern printing, 6 adjust print patterns (A to F) are printed. Enter the adjusted values.

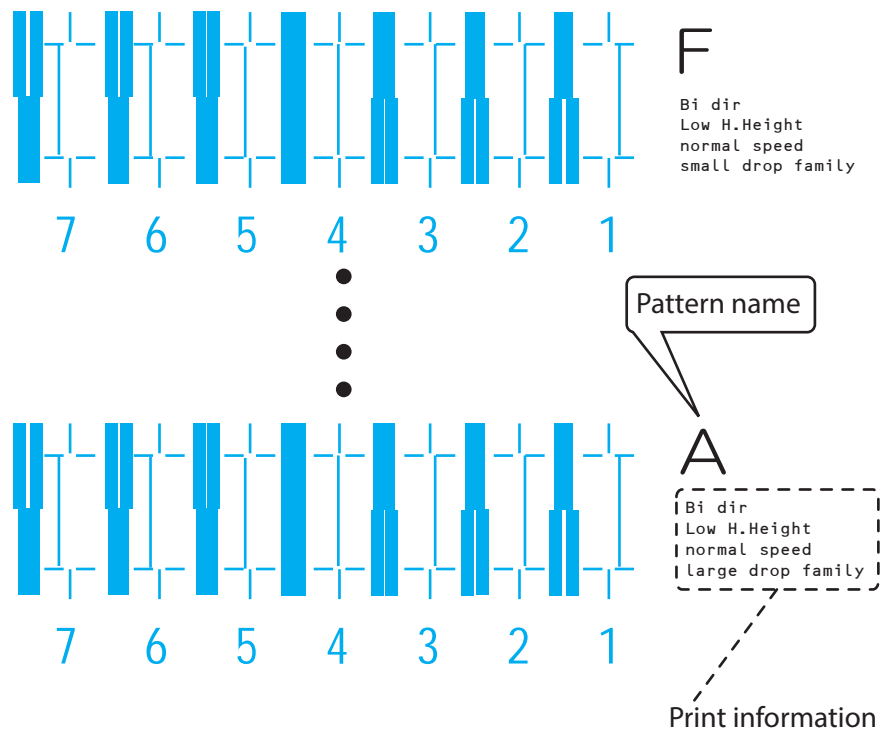

- For the Adjust print pattern, the same patterns will be printed repeatedly on both sides and center of the media.
4. Check the print results on both sides and center of the media and select the number that looks most aligned between 1 and 7.
- “6” is selected in the following pattern.

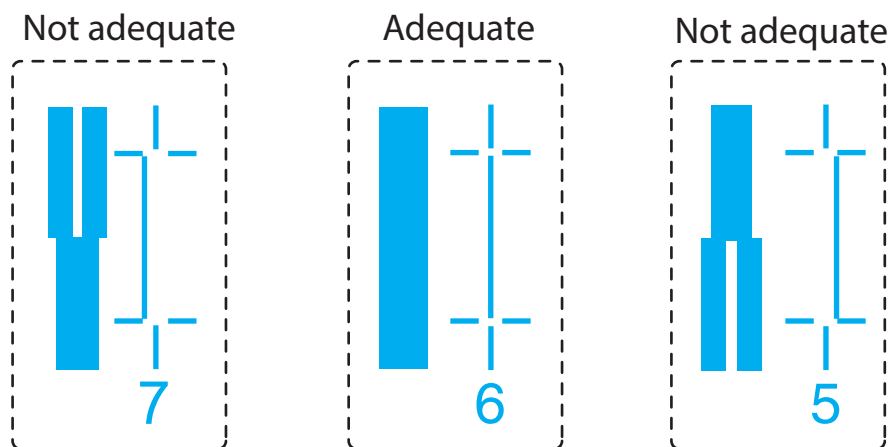

NOTE

- “4” represents the current setting value.
- When the line is aligned, the bold line on its left side does not have a white vertical line in the middle.

- “PatternA: 4” is displayed on the operation panel.

5. Press the [+] key or [-] key to enter the number that you selected in Step 4.

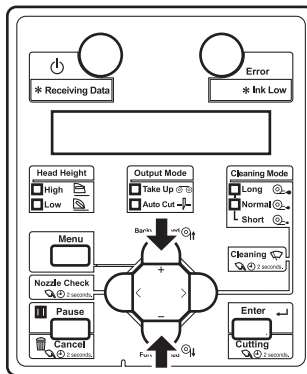
**NOTE**

- When you press the [Cancel] key, the input operation is not executed and “Adj.9: Fine Ptn. ALL” is displayed on the operation panel.

6. Press the [Enter] key on the operation panel.

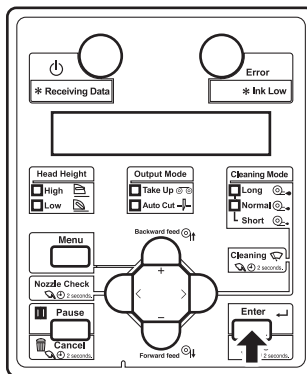

- Determines the setting.

7. Enter the values for patterns B to F in the same way.

- Press the [Enter] key to set the value.
- Once all set values have been entered, press the [Enter] key to register the set values of patterns A to F.
- “Adj.9: Fine Ptn. ALL” is displayed on operation panel.

3.6.3.3.2 Fine Pattern A to F

Print one adjustment pattern from A to F and register the set value.
The following describes how to adjust pattern A only.

1. Go to the Custom Adjust Print menu on operation panel in the same way as Step 2 of “3.6.3.1 Custom Confirmation Pattern”.
2. Press the [+] key or [-] key on operation panel to select “Adj.10: Fine PatternA”.

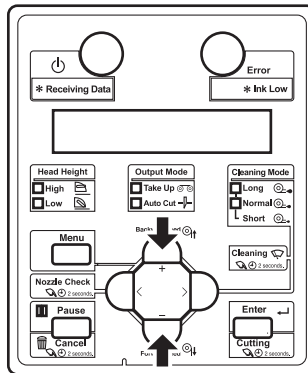

3. Press the [Enter] key on the operation panel.

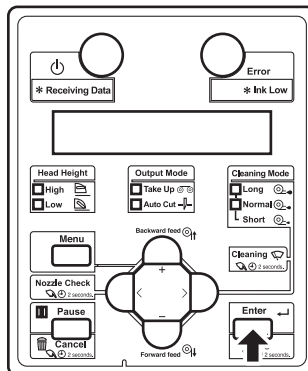

- An micro adjust print pattern is printed.

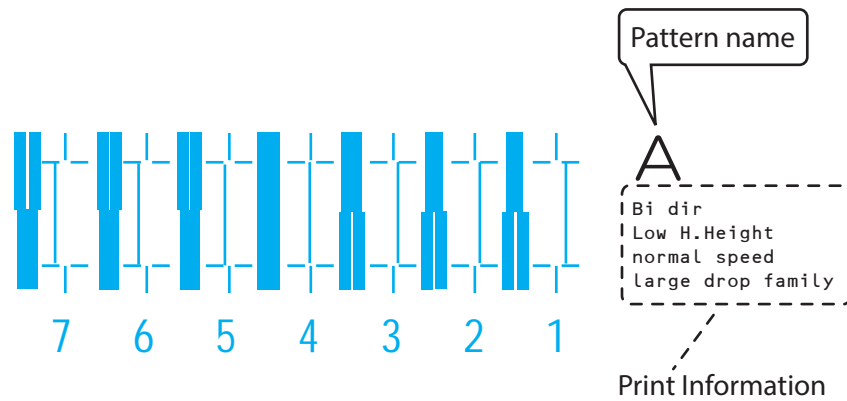

- For the Adjust print pattern, the same patterns will be printed repeatedly on both sides and center of the media.
4. Check the print results on both sides and center of the media and select the number that looks most aligned between 1 and 7.
- “6” is selected in the next printing sample.

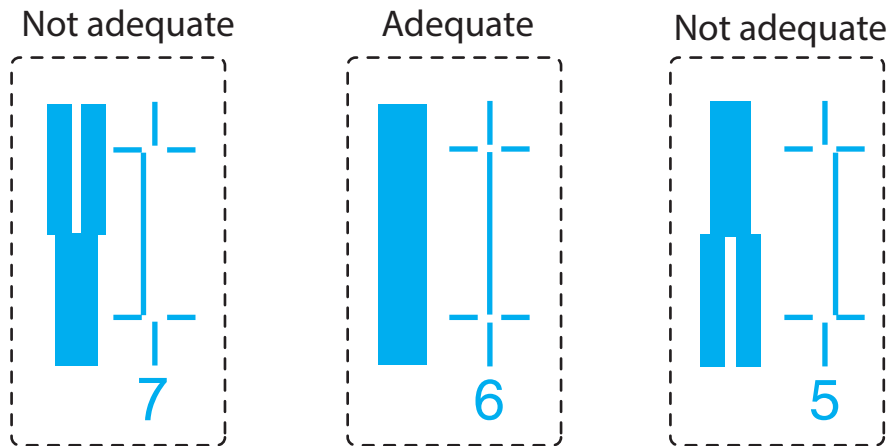

NOTE

- “4” represents the current setting value.
- When the line is aligned, the bold line on its left side does not have a white vertical line.

- “PatternA: 4” is displayed on operation panel.

5. Press the [+] key or [-] key on operation panel to enter the number that you selected in Step 4.

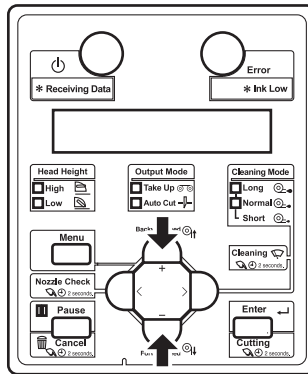

NOTE

- When you press the [Cancel] key on operation panel, the display returns to “Adj10: Fine PatternA”.

6. Press the [Enter] key on operation panel.

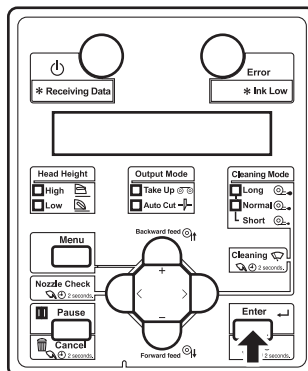

- Determines the setting.
- “Adj. 10: Fine PatternA” is displayed on operation panel.

3.7 Connecting the printer to PC

This section explains how to connect the printer and a PC.

3.7.1 System requirements

The following are the system requirements for this printer.

Operating system	Windows 11, Windows 10
------------------	------------------------

NOTE

- The required memory varies depending on the application software or the print data type.
- A large hard disk and memory are recommended.
- The OS support period of MUTOH software follows the Microsoft support lifecycle policies.

3.7.2 Preparing cables

The printer is equipped with a network interface for connecting with a PC. You need a network interface cable to connect a PC with this printer. Prepare the cable depending on the PC that it will be connected to.

TIP

- About connecting a network interface cable, refer to “[3.7.3 Connecting a network interface cable](#)”.
- For the recommended cable specifications, refer to “[8.2 Interface specification](#)”.

3.7.3 Connecting a network interface cable

This section explains how to connect a network interface cable.

Follow the procedure below to connect this printer to your PC.

1. Turn OFF both the printer and PC.
2. Insert the network interface cable into the network interface connector located on the back of the printer.

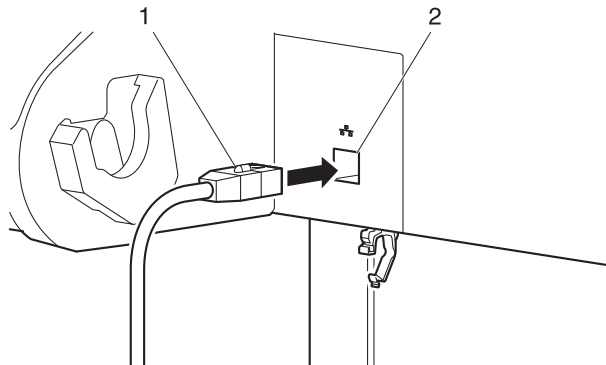

No.	Name
1	Network interface cable
2	Network interface cable connector

3. Fix the network interface cable to the cable clamp.

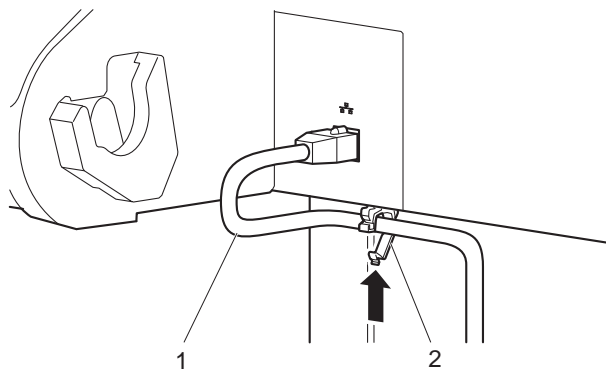

No.	Name
1	Network interface cable
2	Cable clamp

4. Connect the other connector of the network interface cable to your PC.

TIP

- About connecting to your PC, refer to the operation manual included with the PC.
- For network setting on the side of the printer, refer to “[4.3.2 Panel setup menu overview](#)”.

4 Handling the printer

This chapter explains how to handle the printer.

4.1 Print flow chart

The following flow chart illustrates the procedure to perform printing with the printer. Refer to each section as required.

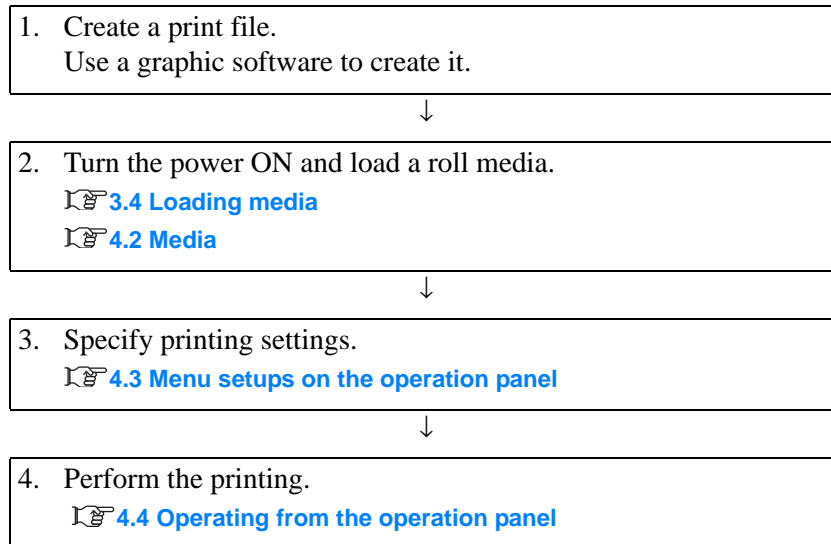

CAUTION

- **Keep the work area ventilated.**
Failure to do so may cause feeling sick from odor or may lead to a fire.

NOTE

Do not open the front cover and maintenance cover during printing.
It will interrupt printing.
Closing the cover will resume printing. However, print quality is not guaranteed.

4.2 Media

This section explains details of available media for this printer.

4.2.1 Media type

The type and quality of media greatly influence the print result. Use media that matches your application, taking the following information into account. Contact your local MUTOH dealer about roll media recommended for your printer.

4.2.2 Cautions on handling media

Note the following points when handling the media.

NOTE

- Use the media under an appropriate environment.
The appropriate temperature and humidity for printing are as follows.

	Temperature	Humidity
Best printing condition	22 °C to 30 °C	40% to 60%
Change rate	Within 2 °C per hour	Within 5 % per hour

- Do not use media which is folded, torn or curl.
- Humidity fluctuations in the work area can change the size of roll media.
Before using a roll media, leave it for 30 minutes in the work area to adapt it to the environment. Performing printing without adapting media to the printing environment may cause media jams due to misalignment or wrinkles in the media.
Print quality is also affected.
- When using the printer in a low-humidity environment, the cut media may stuck and may not come down. In such a case, open the front cover after the media is cut to remove the media.
- Do not touch the print side.
Moisture and oil on your hands may affect the print quality.
- Do not leave media set in the printer for a long time.
Some media has a tendency to bend, causing media jams and degradation of print quality.
Avoid using such media especially in winter or dry condition.
- Do not discard the individual box and bag. Use them for storing media.

4.2.3 Precaution on storing media after use

When storing roll media after use, follow these precautions to avoid print defects caused by cockling.

NOTE

- After removing your roll media from the scroller, wind it back onto the roll properly and put it in the original plastic bag. Then store it in the package it came in.
- Avoid high temperature, high humidity, and direct sunlight when storing media.
- Keep the media dry.

4.2.4 Printing area

The printable area of this printer is as follows.

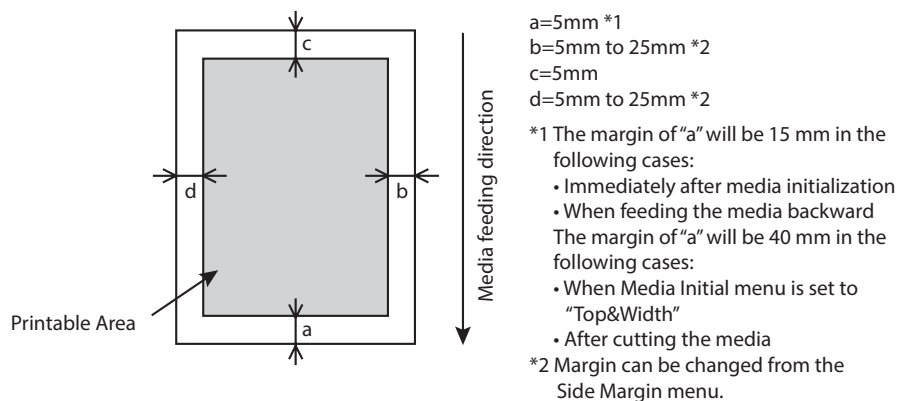

4.2.5 Printhead Height

Normally choose the "Low" or "Middle" head height option depending on the thickness of your media. The closer the gap between the media and the printhead, the better the consistency of the print quality.

NOTE

Depending on the condition of a roll media or media cockling caused by the printer settings, you may get a head strike causing ink smears on the media. In such cases, try followings:

- Release the pressure on the individual pressure arms holding down the area where the cockling occurs.

 [3.4.3 Disabling Pressure Arms Individually](#)

See the table below for the relationship between the head height and the recommended media thickness. Avoid using higher head height unless absolutely necessary, as the wider head gap will cause ink mist to adhere to the printhead nozzles, media or inside of the printer, adversely affecting print quality or leading to damage to the printer parts.

Head height	Recommended media thickness (1.0 mm or less)	Maximum media thickness that printer can feed	Description
Low	0.3 mm or below	0.3 mm	Normally use this head height.
Middle	0.3 mm to 0.8 mm	0.8 mm	Use this option for media between 0.3 mm to 0.8 mm thick or when the head strikes occurs with Low setting.
High	0.8 mm to 1.0 mm	1.3 mm	Avoid using this option if a head strike does not occur with Middle setting. Because of wide distance between the print head and media, printing with "High" setting will generate ink mist, causing the following symptoms: <ul style="list-style-type: none"> • Jetting failure due to nozzle missing • Ink adhesion to media • Ink adhesion to inside of the printer

4.2.5.1 When raising the print head

NOTE

- Print quality will not be guaranteed when the head height is set to High.
- Do not open the front cover or change the head height during printing.
This will change the alignment for printing and print quality will not be guaranteed.
- After you change the head height, make sure to perform the print quality calibration.
☞ [3.6 Adjust Print](#)

1. Open the front cover.

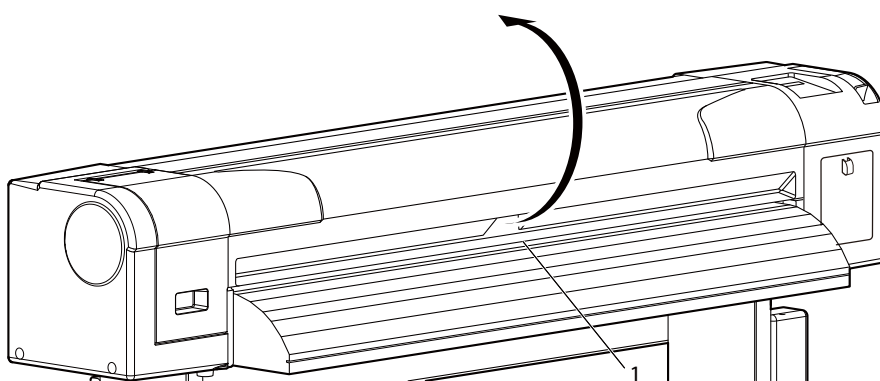

No.	Name
1	Front cover

2. Change the head height by moving the head height adjustment lever (orange).

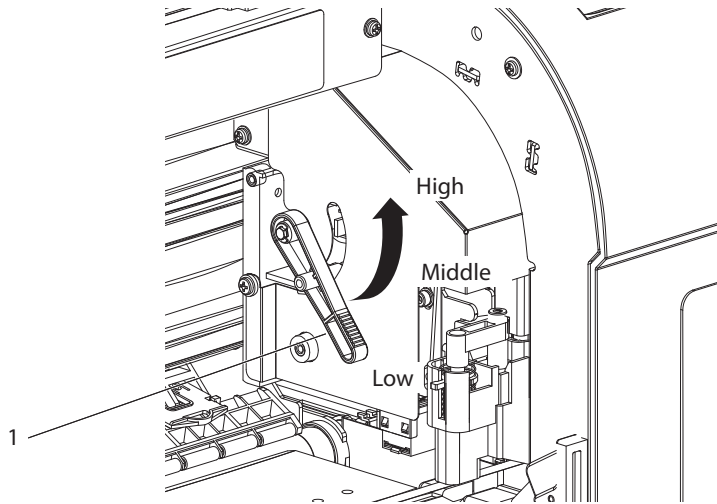

No.	Name
1	Head height adjustment lever

- High: The highest head height setting.
The High lamp on the operation panel lights up in green.
- Middle: Use this option for media between 0.3 mm to 0.8 mm thick or when the head strikes occurs with Low1 setting.
The High lamp and Low lamp on the operation panel lights up in green.
- Low: Default head height. The lowest head height setting.
The Low lamp on the operation panel lights up in green.

3. Close the front cover.

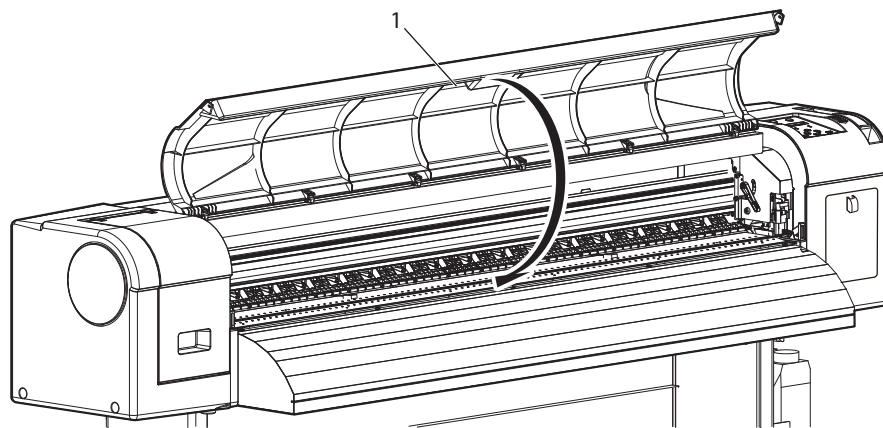

No.	Name
1	Front cover

4.2.5.2 When returning the print head to the original position

NOTE

- Do not open the front cover or change the head height during printing.
This will change the alignment for printing and print quality will not be guaranteed.
- After you change the head height, make sure to perform the print quality calibration.
☞ [3.6 Adjust Print](#)

1. Open the front cover.

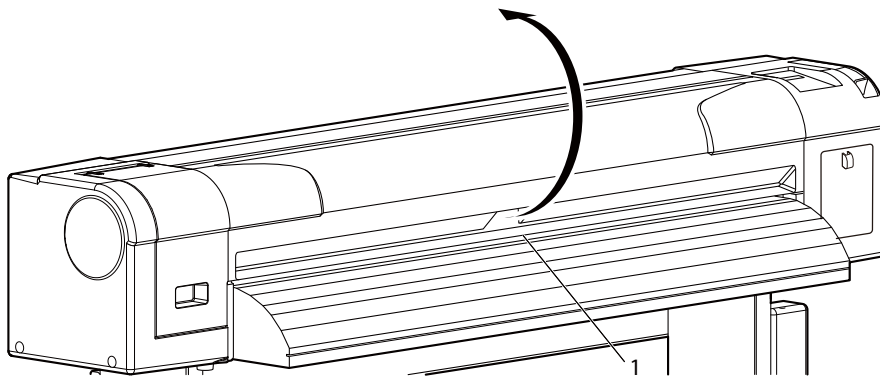

No.	Name
1	Front cover

2. Change the head height by moving the head height adjustment lever (orange).

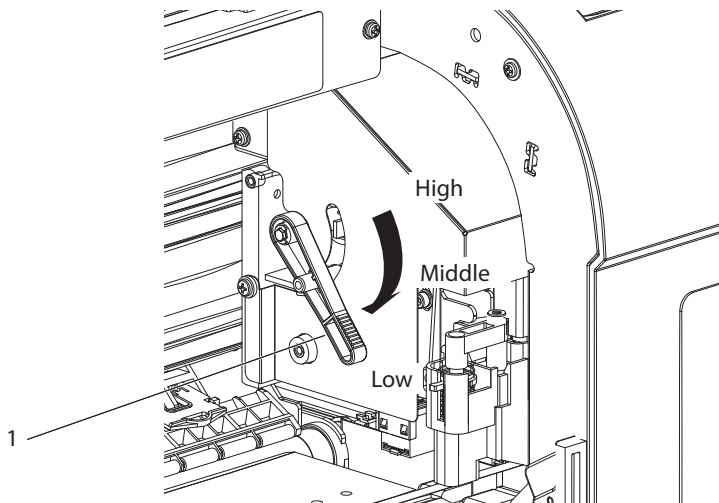

No.	Name
1	Head height adjustment lever

- High: The highest head height setting.
The High lamp on the operation panel lights up in green.
- Middle: Use this option for media between 0.3 mm to 0.8 mm thick or when the head strikes occurs with Low1 setting.
The High lamp and Low lamp on the operation panel lights up in green.
- Low: Default head height. The lowest head height setting.
The Low lamp on the operation panel lights up in green.

3. Close the front cover.

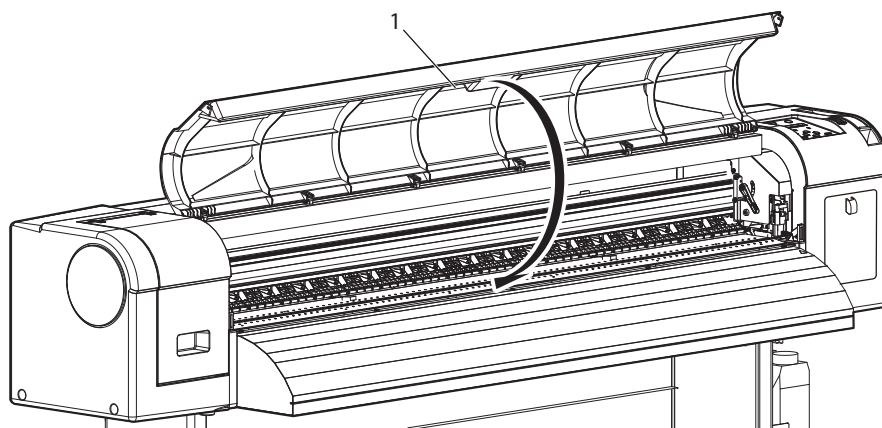

No.	Name
1	Front cover

4.2.6 Media feed adjustment

This section explains the Media feed adjustment.

The feeding length of the printer varies depending on the media type. The following or similar results may be seen in prints if it is not optimized for the media being used.

- Printed images overlap.
- White lines appear on the print.

The accuracy of media feeding may be improved with the following methods.

1. Go to the Dist.Adj menu on the operation panel.
 - a. Press the [Menu] key on the operation panel.
 - “Menu1: Setup>” is displayed on the operation panel.
 - The operation panel shifts to the Setup menu display.
 - b. Press the [>] key on the operation panel.
 - “Set1: User Type” is displayed on the operation panel.
 - c. Press the [Enter] key on the operation panel.
 - “User: Type 1” is displayed on the operation panel.
 - d. Press the [+] key or [-] key on the operation panel to select the media type being loaded.
 - e. Press the [Enter] key on the operation panel.
 - “**>1: Print Mode” is displayed on the operation panel.

TIP

•The selected media (Type 1 to 15) is displayed in “**”.

 [5.1.1 User Type menu](#)

- f. Press the [+] key or [-] key to select “**>3: PF Adjust>”.
- g. Press the [>] key on the operation panel.
 - “PF1: Auto” is displayed on the operation panel.
 - The display goes to Dist.Adj menu.
 -  [5.1.1.1.4 Dist.Adj menu](#)

NOTE

- "PF Adjust" requires at least 400 mm printable width. Before printing, make sure that there is sufficient width on the media. If printable width is less than 400 mm, your printer will not perform printing. Printable width on the media can be adjusted by changing CR origin and side margin (left and right side margin) settings.

🔗 [5.1.3 Side Margin menu](#), [5.1.5 Media Width menu](#), [5.1.8 Origin menu](#)

4.2.6.1 Automatic PF adjustment method

1. Press the [+] key or [-] key to select "PF1: Auto".
 - a. Press the [Enter] key on the operation panel.
 - The printer performs an automatic PF adjustment.
 - If the print defect persists after automatic PF adjustment, perform manual PF adjustment.
🔗 [4.2.6.2 Manual PF adjustment method using adjustment print](#)

4.2.6.2 Manual PF adjustment method using adjustment print

You will need a ruler to perform this adjustment.

1. Press the [+] key or [-] key to select "PF2: Initial Print".
 - a. Press the [Enter] key on the operation panel.
 - "Feed Length: 250 mm" is displayed on the operation panel.

TIP

- The length of media that is fed (feeding length) for Initial Print is normally set at 250 mm.
- If you increase the feeding length, the accuracy of the Media feed adjustment improves.
To change the feeding length, press the [+] key or [-] key on the operation panel and change the set value.

- b. Press the [Enter] key on the operation panel.
 - “Printing” is displayed on the operation panel.
 - The printer prints an initial print pattern.



No.	Name
1	Feed length
2	Media feeding direction

- When the Initial Print is complete, "Ready to Print" is displayed on the operation panel.
- c. Once printed, cut the media.
 - ↳ [4.4.4 Cutting media](#)
2. Measure the distance between the two plus marks (+) in the Initial Print using a ruler.
 3. Enter an initial adjustment value.
 - a. Press the [+] key or [-] key on the operation panel to select “PF3: Initial Change”.
 - b. Press the [Enter] key on the operation panel.
 - “Init.: 250.0/250 mm” is displayed on the operation panel.
 - c. Press the [+] key or [-] key on the operation panel and enter the measured value in step 2.
 - d. Press the [Enter] key on the operation panel.
 - The initial adjustment value is saved.
 - “PF3: Initial Change” is displayed on the operation panel.
 4. Performs Confirm Print.
 - a. Press the [+] key or [-] key on the operation panel to select “PF4: Confirm Print”.
 - b. Press the [Enter] key on the operation panel.
 - “Feed Length: 250 mm” is displayed on the operation panel.

TIP

- The length of media that is fed (feeding length) for Confirm Print is normally set at 250 mm.
 - If you increase the feeding length, the accuracy of the Media feed adjustment improves.
- To change the feeding length, press the [+] key or [-] key on the operation panel and change the set value.

- c. Press the [Enter] key on the operation panel.
 - “Printing” is displayed on the operation panel.
 - The printer prints a confirm print pattern.



No.	Name
1	Feed length
2	Media feeding direction

- When the Confirm Print is complete, "Ready to Print" is displayed.
- d. Cut the media.
 - 🔗 [4.4.4 Cutting media](#)
 5. Measure the distance between the two plus marks in the Confirm Print using a ruler. Then, confirm that the distance matches the feeding length when printing.
 - a. If the distance does not match the feeding length, follow the procedure from Step 1 to Step 4 and readjust.
 - b. If the distance matches the feeding length, proceed to step 6.

6. Perform Micro Print.

- a. Follow the step1 to go to the Dist.Adj menu on the operation panel in the same way as in step 1.
- b. Press the [+] key or [-] key on the operation panel to select “PF5: Micro Print”.
- c. Press the [Enter] key on the operation panel.
 - “Printing” is displayed on operation panel.
 - The printer prints a micro adjustment pattern.
 - Look at the print and find the block pattern that has the least white line or overlap area. The number printed below the adequate pattern is the micro change value.

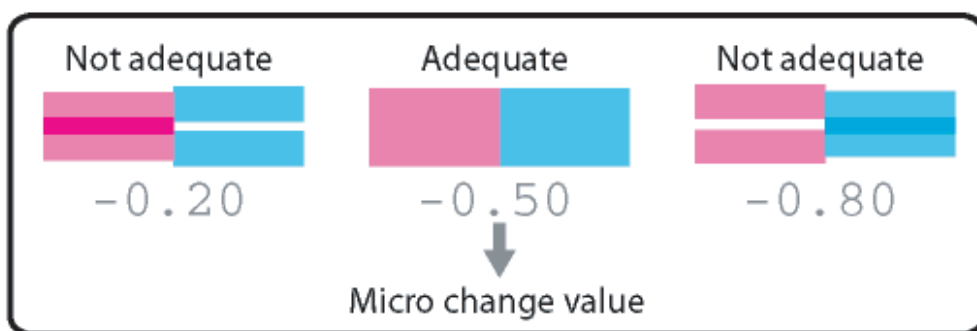

- After the micro adjustment printing is completed, “Micro Change: 0.00%” is displayed on operation panel.

7. Enter the micro adjustment value.

- a. Press the [+] key or [-] key and enter the micro adjustment value according to the printing result in Step 6.
- b. Press the [Enter] key on operation panel.
 - The micro adjustment value is saved. (The saved value will be the reference value from the next print.)
 - “PF5: Micro Print” is displayed on operation panel.
 - The media feed micro adjustment is complete.

4.2.6.3 When you know the adjustment value (when changing the media or for similar operations)

1. Press the [+] key or [-] key to select “PF6: Micro Change”.
 - a. Press the [Enter] key on the operation panel.
2. Enter the adjustment value.
 - a. Press the [+] key or [-] key to enter the adjustment value.
 - b. Press the [Enter] key on the operation panel.
 - The micro adjustment value is saved. (The saved value will be the reference value from the next print.)
 - “PF6: Micro Change” is displayed on operation panel.
 - c. The media feed adjustment is complete.

4.3 Menu setups on the operation panel

4.3.1 Menu setup procedure

Follow the procedure below to configure each setup menu.

1. Check that "Ready to Print" is displayed on the operation panel.
2. Press the [Menu] key on the operation panel.

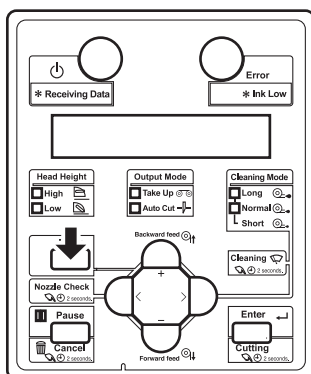

- "Menu1: Setup>" is displayed on the operation panel.
 - The operation panel shifts to the Setup menu display.
3. Press the [+] key or [-] key on the operation panel to select a setup item and press the [Enter] key.

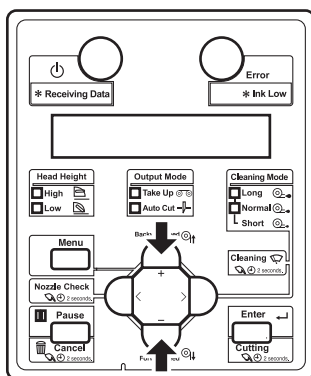

- The settings will be confirmed.
- If the setup item has a submenu, the display goes to the submenu.

NOTE

- When a setup item has a submenu, ">" is displayed on the right end of the LCD monitor of the operation panel.
- For the general outline of each setup item, refer to "[4.3.2 Panel setup menu overview](#)".

4. The setting you can change will blink.
Press the [+] key or [-] key to change the value.

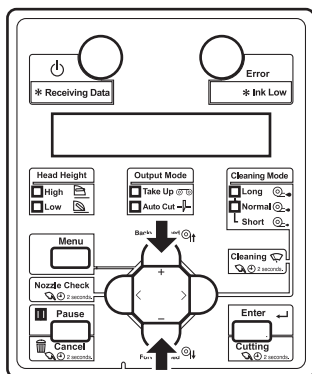

5. To save the change, press the [Enter] key on the operation panel.

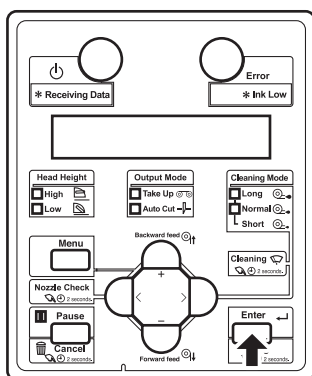

- The setting is saved and the next setup item will be displayed.

NOTE

- If you press the [Cancel] key, [+] key or [-] key without pressing [Enter] key after changing a setting, the change will not be saved.

6. Press the [Cancel] key on the operation panel to exit the setup menu.

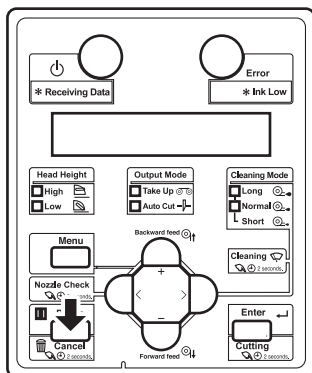

- The display goes back to the upper menu.
- When the main menu is displayed, "Ready to Print" will appear.

4.3.2 Panel setup menu overview

This section explains the Panel setup menu of the printer.
There are the following items in the Panel setup menu.

Setup item	Description
Setup menu	Various settings of the printer are configured.
Test Print menu	Run various test print including nozzle check print, printer setup list print.
Cleaning menu	Performs head cleaning.
Menu Option menu	Sets up the contents of the Setup menu.
System Info menu	Display the system information on your printer.
Sleep Mode menu	Configure the sleep mode settings or put the printer into sleep mode.
Display menu	Select the language and unit to be displayed on the LCD monitor of the operation panel.
Job status	Displays information about the most recent print.
Roll Length Manage menu	Set the remaining roll length settings.

TIP

- For details of each setup item, refer to “[5 Panel setup menu](#)”.

4.4 Operating from the operation panel

This section explains various functions that can be operated from the operation panel.

TIP

- For names and functions of each key, refer to “[2.1.3 Operation panel](#)”.

4.4.1 Feeding media

You can feed the roll media to the position that you want.

Follow the procedure below to feed media.

1. Check that "Ready to Print" is displayed on the operation panel.
2. Make sure that the media loading lever is pulled towards the front.
3. Press the [Forward↓] key or the [Backward↑] key on the operation panel.

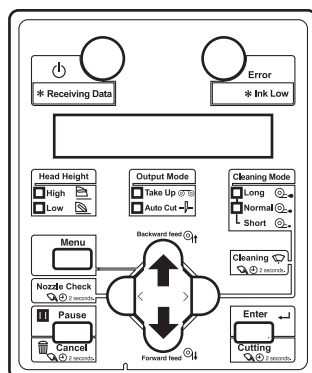

- Media is fed forward or backward.
4. Release the [Backward↑] key or [Forward↓] key on the operation panel after feeding media to the desired position.

4.4.2 Automatic PF adjustment

You can perform an automatic media feed adjustment.

NOTE

- "PF Adjust" requires at least 400 mm printable width. Before printing, make sure that there is sufficient width on the media. If printable width is less than 400 mm, your printer will not perform printing. Printable width on the media can be adjusted by changing CR origin and side margin (left and right side margin) settings.

➤ [5.1.3 Side Margin menu](#), [5.1.5 Media Width menu](#), [5.1.8 Origin menu](#)

Follow the procedure below to Automatic PF adjustment.

1. Check that "Ready to Print" is displayed on the operation panel.
2. Make sure that the media loading lever is pulled towards the front.
3. Press the [Enter] key on the operation panel.

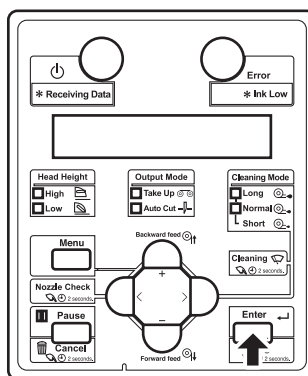

- "Auto PF adjust? No" is displayed on the operation panel.
4. Press the [+] key or [-] key to select "Auto PF adjust? Yes".

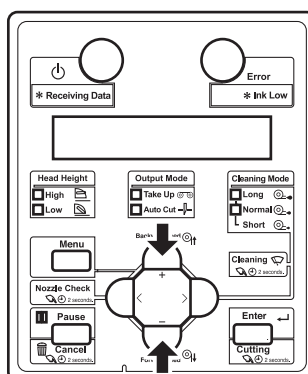

5. Press the [Enter] key on the operation panel.

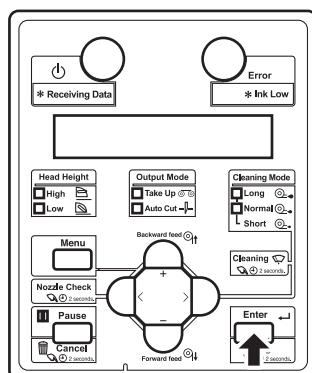

- A confirmation pattern for Automatic PF adjustment is printed.
6. The printer scans the print using the embedded color sensor, then automatically performs a PF adjustment.
 - Once successfully completed, the message “Auto Adjust Succeeded” will appear on the panel.
 - If failed, the message “Auto Adjust Failed” will appear on the panel.
 - In the following cases, perform manual PF adjustment.
 - ☞ **4.2.6 Media feed adjustment**
 - If the print defect persists after automatic PF adjustment.
 - If the automatic PF adjustment failed.

4.4.3 Canceling printing

If you want to cancel a print job for some reason, follow these steps.

1. Cancel a print job sending from the computer to the printer.
2. Press the [Cancel] key on the operation panel for two seconds.

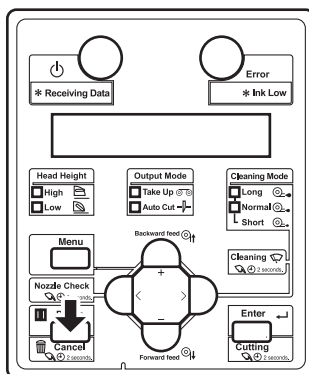

- The printer operates as follows.

Printer status	Operation with the [Cancel] key pressed for two seconds
During printing	The printer terminates printing and delete the print job.
Receiving data/analyzing data	The printer deletes the print job already received or processed.

NOTE

- If many print jobs are sent to the printer, the printer may not be able to go back to "Ready to Print" status by pressing the [Cancel] key.
In such cases, wait for a few seconds and press the [Cancel] key again.

4.4.4 Cutting media

This section explains how to cut media.

If output mode is set to “Cut”, the printer cuts the media automatically after printing.

5.1.6 Output Mode menu

If you press the [Cutting] key on the operation panel more than two seconds while the printer is in ready-to-print status, you can cut the media at the desired position.

Follow the procedure below to cut the roll media.

1. Check that "Ready to Print" is displayed on the operation panel.
2. Press the [Cutting] key on the operation panel for more than two seconds.

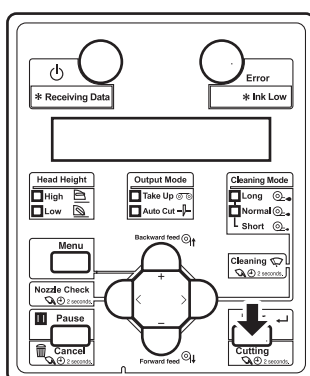

- The printer feeds the roll media to the length of the margin and cuts the media.

NOTE

- When loading the new roll media, cut the leading edge of the media if it is not straight.
- The cutter is a consumable item.
Replace it periodically.
-  [6.1.3 Replacing Cutter](#)
- When the media detection is set to "Off", the media cannot be cut automatically.

4.4.5 Cutting media manually

This section explains how to cut the roll media manually.

Follow the procedure below to cut the roll media.

1. Verify the following regarding the operational condition of the product.
 - Printing or other operations are not in progress.
 - "Ready to Print" is displayed on the operation panel.
2. To change the position to cut the roll media, refer to "4.4.1 Feeding media" and advance the roll media to the desired cut position.
3. Place a razor blade on the media cut groove on the media guide, and cut the roll media.

CAUTION

- **Follow these precautions when cutting roll media.**
Mishandling the razor blade may cause a cut on your finger or hand.
 - **When you hold media, do not place your finger on the media cut groove.**
 - **Slowly cut the media along the media cut groove.**

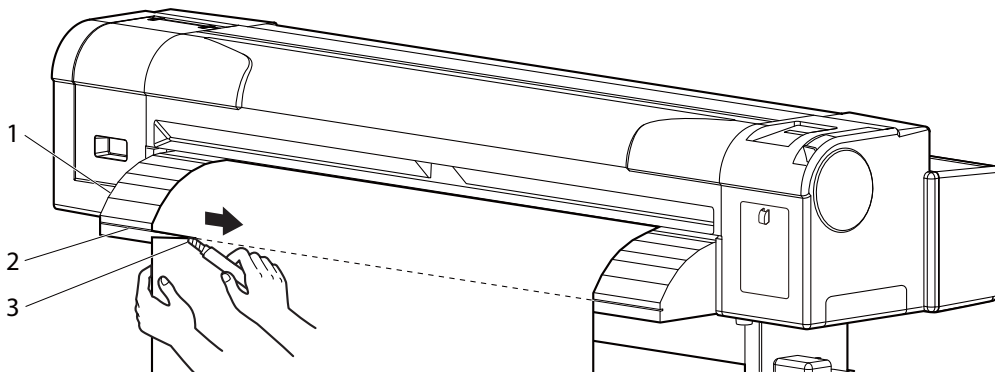

No.	Name
1	Media guide
2	Media cut groove
3	Razor blade

- The procedure for cutting the roll media is complete.

NOTE

- When loading the new roll media, cut the leading edge of the media if it is not straight.

4.4.6 Changing and confirming settings while printing

While the printer is operating, you can change or confirm settings for the Panel setup menu.

4.4.6.1 Procedure for changing and confirming settings while printing

Follow the procedure below to change or confirm settings for the Panel setup menu.

1. Confirm that the printer is in one of the following conditions.
 - Receiving data
 - Analyzing data
 - Printing
2. Press the [Menu] key on the operation panel.

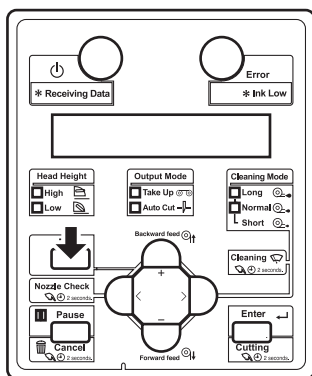

- “Menu5: Temperature” is displayed on the operation panel.
3. Press the [+] key or [-] key to change or confirm settings.

NOTE

- For the setting items whose settings can be changed or confirmed, refer to “[4.4.6.2 Settings that can be changed or confirmed while printing](#)”.

4.4.6.2 Settings that can be changed or confirmed while printing

NOTE

- When you change a setting during operation, be sure to select “Backup” to save the setting that you changed.
If the printer returns to Normal without “Backup” being selected, the changed setting is not saved.
- Check the following before using the Job status items
 - The values displayed in the Job status items are rough indications. They do not guarantee the strict accuracy.
 - If the length information is not included in the print data, “0” is displayed for all items.
 - You can check the “remaining print” and “remaining time” in the way described in [☞ 4.4.8 Normal Display while Printing](#).
 - To check the information about the printed data, refer to the following.

Setup item	Setting	Description	Reference
PF Adjust	-5.00% to 0.00 to 5.00%	Change the feed adjustment value.	☞ 5.1.1.1.4 Dist.Adj menu
Backup	—	• [Enter] key: Save the changed setting.	—
Job Status	ToDo Length	• Check the whole length of the data (media feed direction) currently being printed.	—
	Done	• Check the printed length of the data currently being printed.	
	Remain	• For the data currently being printed, check the length of the data that has not been printed.	
	Remain Time	• Displays the time remaining for printing.	
	—	• [Cancel] key: The printer returns to Normal.	—

4.4.7 Pausing printing

It is possible to pause to print during printing.

Follow the procedure below to pause or restart printing.

NOTE

- If the printing is paused, the print quality will not be guaranteed.

1. Check that the printer is in operating.
2. Press the [Pause] key on the operation panel.

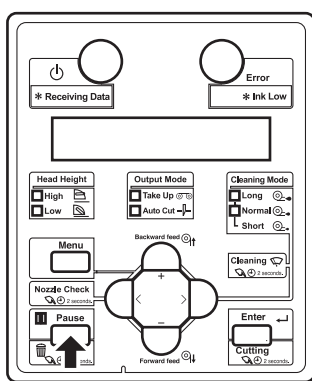

- The printer pauses printing.
 - “PrintRestart -> Enter” is displayed on the operation panel.
3. To restart printing, press the [Enter] key on the operation panel.

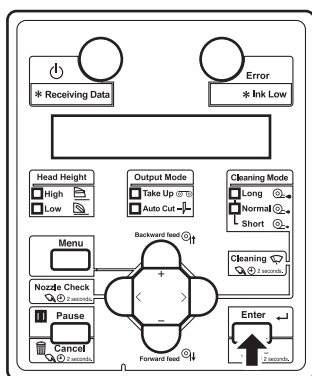

- The printer restarts printing.

4.4.8 Normal Display while Printing

The remaining length and remaining time to complete the currently printing data can be displayed by an easy operation.

NOTE

- The values displayed in this function are just standard values, not guarantee the accuracy.
- If the print data includes no length data, all information will be displayed as “0”.
- To check more detailed information of currently printing data, please refer to the below.
[☞ 4.4.6.2 Settings that can be changed or confirmed while printing](#)
- To check the information of printed data, please refer to the below.
[☞ 5.8 Job Status Menu](#)

Follow the procedures below to display the information.

1. Check if the printer is printing a data.
2. Press [-] key on the operation panel to display “Print Remain”.

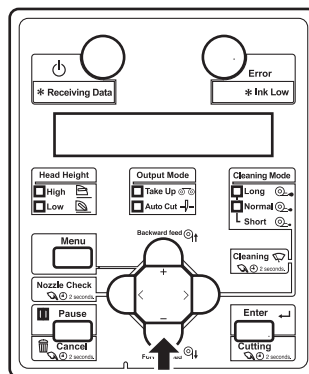

- The remaining length of data currently printing will be displayed.

P r i n t R e m a i n x x x . x m

TIP

- When the length display setting is set to inch, the length will be displayed in inch.
[☞ 5.7.3 Length menu](#)
- The [+] key on the operation panel also can switch the display. In that case, “Remain Time” (Step 3) will be displayed first.

3. Press [-] key on the operation panel to display “Remain Time”.

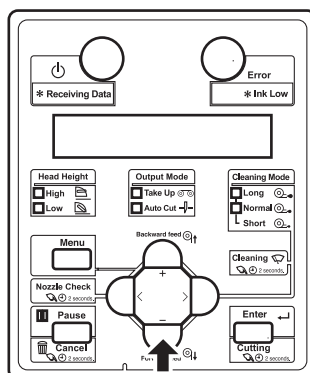

- The remaining length of data currently printing will be displayed.

R e m a i n T i m e x x x x m i n

4. To return the display to [Printing], press [-] key on the operation panel.

P r i n t i n g

5 Panel setup menu

The section explains the Setup menu of the printer.









Setup item	Description
Setup menu	Various settings of the printer are configured. ☞ 5.1 Setup menu
Test Print menu	Performs nozzle check of the print head and setup list. ☞ 5.2 Test Print Menu
Cleaning menu	Performs head cleaning. ☞ 5.3 Cleaning menu
Menu Option menu	Sets up the contents of the Setup menu. ☞ 5.4 Menu Option menu
System Info menu	Display the system information on your printer. ☞ 5.5 System Information menu
Sleep Mode menu	Sleep mode settings are configured. ☞ 5.6 Sleep Mode menu
Display	Sets the language and unit displayed on the LCD monitor of the operation panel. ☞ 5.7 Display menu
Job Status menu	Displays information about the previous printing result of the Job status. ☞ 5.8 Job Status Menu
Roll Length Manage menu	Set the remaining roll length settings. ☞ 5.9 Roll Length Manage menu













TIP

The <> parts in each list are factory default settings (default).

5.1 Setup menu



Various settings of the printer are configured.

Setup item	Description
User Type	Sets the user type setting for printing. <ul style="list-style-type: none"> [Enter] key: shifts to the sub menu.  5.1.1 User Type menu
Spitting	Sets up the spitting operation while printing. <ul style="list-style-type: none"> [Enter] key: shifts to the sub menu.  5.1.2 Spitting menu
Side Margin	Specifies the right and left margins of printed media. <ul style="list-style-type: none"> [Enter] key: shifts to the sub menu.  5.1.3 Side Margin menu
Media Initial	Sets whether to detect the media width and edge while initializing the media. <ul style="list-style-type: none"> [Enter] key: shifts to the sub menu.  5.1.4 Media Initial menu
Media Width	Specifies the media width between the loading mark and the left end if media detection is not performed during media initialization. Displays the detected media width if media detection is performed during media initialization. <ul style="list-style-type: none"> [Enter] key: shifts to the sub menu.  5.1.5 Media Width menu
Output mode	Sets the media ejection method after printing. <ul style="list-style-type: none"> [Enter] key: shifts to the sub menu.  5.1.6 Output Mode menu
Method of Cut	Sets the media cutting method after printing. <ul style="list-style-type: none"> [Enter] key: shifts to the sub menu.  5.1.7 Method of Cut menu
Origin	Sets the beginning of printing (origin) of the print data. <ul style="list-style-type: none"> [Enter] key: shifts to the sub menu.  5.1.8 Origin menu
Head Travel	Sets up the range that the print head moves while printing. <ul style="list-style-type: none"> [Enter] key: shifts to the sub menu.  5.1.9 Head Travel menu
Multi Strike	Sets up the overwrite count per line. <ul style="list-style-type: none"> [Enter] key: shifts to the sub menu.  5.1.10 Multi Strike menu
Strike Wait	Sets up the waiting time while overwrite printing. <ul style="list-style-type: none"> [Enter] key: shifts to the sub menu.  5.1.11 Strike Wait menu
Slant Check	Sets up slanting detection during media loading. <ul style="list-style-type: none"> [Enter] key: shifts to the sub menu.  5.1.12 Slant Check menu
Auto Cleaning	Sets up the time for auto cleaning during standby, before printing, and during printing. <ul style="list-style-type: none"> [Enter] key: shifts to the sub menu.  5.1.13 Auto Cleaning menu

Setup item	Description
Longstore	Wash the print head with the cleaning fluid. <ul style="list-style-type: none"> • [Enter] key: shifts to the sub menu.  5.1.14 Longstore menu
CR Maintenance	Performs maintenance. <ul style="list-style-type: none"> • [Enter] key: shifts to the sub menu.  5.1.15 CR Maintenance menu
Initialization	Returns the settings of the printer to default. <ul style="list-style-type: none"> • [Enter] key: shifts to the sub menu.  5.1.16 Initialization menu
IP Address	Sets the IP address of the printer. <ul style="list-style-type: none"> • [Enter] key: shifts to the sub menu.  5.1.17 IP Address menu
Subnet Mask	Sets the subnet mask of the printer. <ul style="list-style-type: none"> • [Enter] key: shifts to the sub menu.  5.1.18 Subnet Mask menu
Gateway	Sets the gateway. <ul style="list-style-type: none"> • [Enter] key: shifts to the sub menu.  5.1.19 Gateway menu
Header dump	Set whether or not to print the dump data of print data. <ul style="list-style-type: none"> • [Enter] key: shifts to the sub menu.  5.1.20 Header Dump menu
Start Feed	Rewinds or feeds the media the amount specified by the set value. <ul style="list-style-type: none"> • [Enter] key: Moves to the sub menu.  5.1.21 Start Feed Menu
Alert Buzzer	Selects how to turn off the printer beep sound when an error occurs. <ul style="list-style-type: none"> • [Enter] key: shifts to the sub menu.  5.1.22 Alert Buzzer menu
Front Interlace	Sets the media edge treatment function. <ul style="list-style-type: none"> • [Enter] key: shifts to the previous menu.  5.1.23 Front Interlace Menu
Nozzle Select	You can set whether to reduce the print head nozzles for printing. <ul style="list-style-type: none"> • [Enter] key: shifts to the sub menu.  5.1.24 Select Nozzle menu
Temporary	Displays the menus which have been set to hide in the Menu Option menu temporarily. <ul style="list-style-type: none"> • [Enter] key: returns to the previous menu with all set up items displayed. • [Cancel] key: returns to the previous status in the Selection menu when the Setup menu is displayed.  5.4 Menu Option menu
—	<ul style="list-style-type: none"> • [Cancel] key: shifts to the previous menu.  5 Panel setup menu

5.1.1 User Type menu









Sets the user type setting for printing.

Setup item	Setting	Description
User Type	Type 1	Settings for the media type to print are configured. It is possible to set 15 different user settings as “Type 1 to 15” for printing. • [Enter] key: shifts to the sub menu.  5.1.1.1 User Type menu
	Type 2	
	...	
	Type 14	
	Type 15	
	—	• [Cancel] key: saves the setting and shifts to the previous menu.  5.1 Setup menu

5.1.1.1 User Type menu

Various settings on the user type settings are configured.

In the user type menu, 15 different settings can be set as Type 1 to 15 for the following printing operation.

Setup item	Setting	Description
Type 1 to 15	PrintMode	Sets up the Print Mode according to the usage of print data or print speed. <ul style="list-style-type: none"> [Enter] key: shifts to the sub menu.  5.1.1.1.1 Print Mode menu
	Effect	Sets up the Effect menu. <ul style="list-style-type: none"> [Enter] key: shifts to the sub menu.  5.1.1.1.2 Effect menu
	Adjust Print	Sets up when adjusting the printer for the optimum quality of image print. <ul style="list-style-type: none"> [Enter] key: shifts to the sub menu.  5.1.1.1.3 Adjust Print menu
	PF Adjust	Sets up various settings on the media feed adjustment. <ul style="list-style-type: none"> [>] key: shifts to the sub menu.  5.1.1.1.4 Dist.Adj menu
	Vacuum Fan	Sets up vacuum fan operation. <ul style="list-style-type: none"> [Enter] key: shifts to the sub menu.  5.1.1.1.5 Vacuum Fan menu
	Media Thickness	Set the thickness of the media you are using. <ul style="list-style-type: none"> [Enter] key: shifts to the sub menu.  5.1.1.1.6 Media thickness menu
	User Copy	Collectively copies the setting values of the user type currently selected to a different user type. <ul style="list-style-type: none"> [Enter] key: shifts to the sub menu.  5.1.1.1.7 User Copy menu
	—	<ul style="list-style-type: none"> [Cancel] key: shifts to the previous menu.  5.1.1 User Type menu

5.1.1.1.1 Print Mode menu

Settings for print quality (Print Mode) are set according to the usage of print data or print speed.

Setup item	Setting	Description
Mode	High Quality	Set the print mode. <ul style="list-style-type: none"> • High Quality: Select this if you are looking for better print quality than the Quality print mode. This mode prints with maximum print resolution at minimum print speed. • Quality: Select this for high quality printing. This mode prints with high print resolution at low print speed. • Production: Select this for high-speed printing. This mode prints at fast print speed with low print resolution. • High Speed: Select this if you want to maximize productivity. This mode prints at maximum print speed with minimum print resolution. ⓘ 5.1.1.1.2 Effect menu
	<Quality>	
	Production	
	High Speed	
	—	<ul style="list-style-type: none"> • [Enter] key: saves the setting and shifts to the sub menu. • [Cancel] key: cancels the setting and shifts to the previous menu. ⓘ 5.1.1.1 User Type menu

NOTE

The colors of the image may become irregular depending on the media and print mode you are using. In such a case, use the following mode to improve irregular colors.

- When using Production or High Speed, change it to High Quality or Quality.

5.1.1.1.2 Effect menu

Sets up the Effect menu.

Set up this menu when you want to improve print quality by adjusting the set Print Mode.

NOTE

- The print quality may not be improved depending on the printing condition.

Setup item	Setting	Description
Effect	None	The Effect function is not used.
	Wave	The printing joint will be the wave form. The print quality may be improved than “None”.
	Fine & Fuzz	The printing joint will shade off as the wave form. Perform the printing at slower speed than “Wave”.
	Fine & Fog *1	The printing joint will shade off. Set up this menu to improve horizontal banding with “Fine & Fuzz”. Perform the printing at a slower speed than “Fine & Fuzz”.
	i-Weave EX	Edges between each pass are barely noticeable and seamless.
	i-Screen *1	Edges between each pass are barely noticeable and more seamless.
	—	<ul style="list-style-type: none"> [Enter] key: saves the setting and shifts to the previous menu. [Cancel] key: cancels the setting and shifts to the previous menu.  5.1 Setup menu

*1 The default value of the effect differs depending on the selected print mode as shown below.

Print Mode	Effect Default Value
High Quality	i-Screen
Quality	
Production	
High Speed	Fine&Fog

5.1.1.1.3 Adjust Print menu

Sets up when adjusting the printer for the optimum quality of image print.

This setting is different for each user type setting.

NOTE

- This printer was adjusted at the factory shipment so that it obtains the optimum printing quality. Adjust the quality if the print quality changes after the installation environment or the media is changed.
- If print defects (like banding or grainy look) still appear on the print, try an auto calibration again, or go to "Standard" or "Custom" to perform calibration.
 - ☞ [3.6.2 Standard Adjust Print](#)
 - ☞ [3.6.3 Custom Adjustment Pattern](#)
- After performing Standard adjust print and changing the user type setting, make sure to perform Adjust print.
- When performing Custom adjust print, the print modes are adjusted all at once. Therefore, you do not need to perform print adjustment even when the user type setting has been newly set or changed.
- When using RIP software, etc, and setting the resolution which is different from the setting in the user type setting, make sure to perform adjustment for all print modes by Custom Adjust Print.
- "Adjust Print" requires at least 550 mm printable width. Before printing, make sure that there is sufficient width on the media.
If printable width is less than 550 mm, your printer will not perform printing. Printable width on the media can be adjusted by changing CR origin and side margin (left and right side margin) settings.
 - ☞ [5.1.3 Side Margin menu](#), [5.1.5 Media Width menu](#), [5.1.8 Origin menu](#)

Setup item	Setting	Description
Adjust Print	Media Thickness	Shifts to the menu where you can enter the thickness of the media you are using. ☞ 5.1.1.1.6 Media thickness menu
	—	<ul style="list-style-type: none"> • [Cancel] key: shifts to the previous menu. ☞ 5.1.1.1 User Type menu

Media thickness menu

Setup item	Setting	Description
Media Thickness	80 μ m to <170 μ m> to 1300 μ m	Enter the thickness of the media you are using. <ul style="list-style-type: none"> • [Enter] key: saves the setting and shifts to the sub menu. ☞ Auto Adjust Print Menu ☞ Standard Adjust Print Menu ☞ Custom Adjust Print Menu
	—	<ul style="list-style-type: none"> • [Cancel] key: shifts to the previous menu. ☞ 5.1.1.1 User Type menu

NOTE

- The settings here are the same as [5.1.1.1.6 Media thickness menu](#).

Auto Adjust Print Menu

Perform the automatic adjustment using the embedded color sensor.

Setup item	Setting	Description
Adj. Print1: Auto	ALL	Perform automatic adjustment for all patterns (A to F) using the color sensor. 3.6.1 Auto Adjust Print
	Standard	Perform automatic adjustment for the currently selected print mode using the color sensor (calibrate the same print mode as "Standard Adjust Print Menu"). 3.6.1 Auto Adjust Print
	Pattern A to F	Choose the adjustment pattern between A and F for automatic adjustment. 3.6.1 Auto Adjust Print
	—	<ul style="list-style-type: none"> [Cancel] key: cancels the setting and shifts to the previous menu. 5.1.1.1.3 Adjust Print menu







Standard Adjust Print Menu

Adjusts only the print mode in the user type setting which is currently set.

Setup item	Setting	Description
Adj. Print2: Standard	Confirm Ptn.	Print the test pattern for the alignment. Check before adjusting. 3.6.2.1 Standard Confirmation Pattern
	Rough Pattern	Perform this adjustment when the misalignment is large. Print adjustment patterns and enter the set values. 3.6.2.2 Standard Rough Adjustment Pattern
	Fine Pattern	Perform this adjustment when the misalignment is small. Print adjustment patterns and enter the set values. 3.6.2.3 Standard Micro Adjustment Pattern
	—	<ul style="list-style-type: none"> [Cancel] key: cancels the setting and shifts to the previous menu. 5.1.1.1.3 Adjust Print menu







Custom Adjust Print Menu

Perform adjustment for all patterns (A to F).
All print modes will be adjusted.

Setup item	Setting	Description
Adj. Print3 : Custom	Confirm Ptn.	The test patterns of A to F will be printed for Adjust print. Check before adjusting.  3.6.3.1 Custom Confirmation Pattern
	Rough Ptn. ALL	Perform this when the degree of misalignment is large. Print Adjust patterns A to F and enter the set values.  3.6.3.2.1 Rough Pattern ALL
	Rough Pattern A to F	When the degree of misalign is big, print out an adjust pattern selected from A to F and enter the value.  3.6.3.2.2 Rough Pattern A to F
	Fine Ptn. ALL	Perform this when the degree of misalignment is small. Print Adjust patterns A to F and enter the set values.  3.6.3.3.1 Fine Pattern ALL
	Fine Pattern A to F	When the degree of misalign is small, print out an adjust pattern selected from A to F and enter the value.  3.6.3.3.2 Fine Pattern A to F
	—	<ul style="list-style-type: none"> [Cancel] key: shifts to the previous menu.  5.1.1.1.3 Adjust Print menu

5.1.1.1.4 Dist.Adj menu

Sets up various settings on the media feed adjustment.

Setup item	Setting	Description
PF	Auto	The printer performs an automatically PF adjustment. <ul style="list-style-type: none"> [Enter] key: shifts to the sub menu.  (1) Auto menu
	Initial Print	Performs Initial Adjust Print. <ul style="list-style-type: none"> [Enter] key: shifts to the sub menu.  (2) Initial Print menu
	Initial Change	Sets up Initial Adjust Change. <ul style="list-style-type: none"> [Enter] key: shifts to the sub menu.  (3) Init.Adj.Change menu
	Confirm Print	Performs Confirm Print. <ul style="list-style-type: none"> [Enter] key: shifts to the sub menu.  (4) Confirm Print menu
	Micro Print	Performs Micro Adjustment Print. <ul style="list-style-type: none"> [Enter] key: shifts to the sub menu.  (5) Micro Print menu
	Micro Change	Sets up Micro Adjustment Change. <ul style="list-style-type: none"> [Enter] key: shifts to the sub menu.  (6) Micro Adj.Change menu
	—	<ul style="list-style-type: none"> [Cancel] key: shifts to the previous menu.  5.1.1.1 User Type menu

NOTE

- "PF Adjust" requires at least 400 mm printable width. Before printing, make sure that there is sufficient width on the media. If printable width is less than 400 mm, your printer will not perform printing. Printable width on the media can be adjusted by changing CR origin and side margin (left and right side margin) settings.

 **5.1.3 Side Margin menu, 5.1.5 Media Width menu, 5.1.8 Origin menu**

(1) Auto menu

The printer performs an automatically PF adjustment.

Setting	Description
—	<ul style="list-style-type: none"> • [Enter] key: Printer performs an automatically PF adjustment.
	<ul style="list-style-type: none"> • [Cancel] key: cancels the setting and shifts to the previous menu.  5.1.1.1.4 Dist.Adj menu

(2) Initial Print menu

Performs Initial Adjust Print.

Setup item	Setting	Description
FeedLength	100mm to <250mm> to 500mm	Changes the length (feed length) of the media feed direction for Initial Print. <ul style="list-style-type: none"> • [Enter] key: Determines the setting. “Printing” is displayed on the operation panel and Initial Print starts. After printing, "Ready to Print" is displayed.
	—	<ul style="list-style-type: none"> • [Cancel] key: cancels the setting and shifts to the previous menu.  5.1.1.1.4 Dist.Adj menu

(3) Init.Adj.Change menu

Sets up Initial Adjust Change.

Setup item	Setting	Description
Init.	The set value ± 50.0 mm in “Feed length” of Initial adjust print	Sets up Initial Adjust Change. e.g) When the set value in “Feed length*” of Initial adjust print is set to 250mm, the adjustment range in this menu is 200mm to 300mm.
	—	<ul style="list-style-type: none"> • [Enter] key: saves the setting and shifts to the previous menu. • [Cancel] key: cancels the setting and shifts to the previous menu.  5.1.1.1.4 Dist.Adj menu

(4) Confirm Print menu

Performs Confirm Print.

Setup item	Setting	Description
FeedLength	100mm to <250mm> to 500mm	<p>Changes the length (feed length) of the media feed direction for Confirm Print.</p> <ul style="list-style-type: none"> [Enter] key: Determines the setting. "Printing" is displayed on the operation panel and Initial Print starts. After printing, "Ready to Print" is displayed.
	—	<ul style="list-style-type: none"> [Cancel] key: cancels the setting and shifts to the previous menu. <p> 5.1.1.1.4 Dist.Adj menu</p>

(5) Micro Print menu

Performs Micro Adjustment Print.

Setup item	Setting	Description
Micro Print	-5.00% to <0.00%> to 5.00% (After printing)	<ul style="list-style-type: none"> Prints a micro adjustment pattern based on the currently set micro adjustment value with each of the following values applied to it. ±0.10%、±0.20%、±0.50%、±0.80%、±1.20% After printing, enter a micro adjustment value in the following range: -5.00% ~ <0.00%> ~ 5.00%
	—	<ul style="list-style-type: none"> [Cancel] key: shifts to the previous menu. Stops printing and returns to the previous menu if printing is in progress. <p> 5.1 Setup menu</p>

(6) Micro Adj.Change menu

Sets up Micro Adjustment Change.

Setup item	Setting	Description
Micro Adj.Change	-5.00% to <0.00%> to 5.00%	Sets up Micro Adjustment Change.
	—	<ul style="list-style-type: none"> [Enter] key: saves the setting and shifts to the previous menu. [Cancel] key: cancels the setting and shifts to the previous menu. <p> 5.1 Setup menu</p>

5.1.1.1.5 Vacuum Fan menu

Sets up vacuum fan operation.

Setup item	Setting	Description
Vacuum Fan	Off	The Vacuum fan operation is not performed.
	Low	Set when there is a possibility of a paper jam caused by failure in media loading when the setting is Medium.
	Medium	Set this when there is a possibility that media feeding may fail and paper may be jammed with the High setting.
	<High>	Set when using general media.
	—	<ul style="list-style-type: none"> • [Enter] key: saves the setting and shifts to the previous menu. • [Cancel] key: cancels the setting and shifts to the previous menu. 🔗 5.1.1.1 User Type menu

5.1.1.1.6 Media thickness menu

Sets the thickness of the media you are using.

Once the media thickness is entered, print quality is automatically adjusted.

Setup item	Setting	Description
Media Thickness	80 μ m to <170 μ m> to 1300 μ m	Enter the thickness of the media you are using in increments of 10 μ m.
	-	<ul style="list-style-type: none"> • [Enter] key: saves the setting and shifts to the previous menu. • [Cancel] key: cancels the setting and shifts to the previous menu. 🔗 5.1.1.1 User Type menu

NOTE

- This menu is to automatically adjust print quality to a certain extent. If you want to improve print quality, manually adjust it.
[🔗 3.6 Adjust Print](#)
- There is no problem even if you adjust print quality without setting the media thickness.

5.1.1.1.7 User Copy menu

Collectively copies the setting values of the user type currently selected to a different user type. The following setting values are copied.

- Print mode
- Effect
- Adjustment value for the adjustment print
- Feed adjustment (initial adjustment printing length, initial adjustment value, micro adjustment value)
- Vacuum Fan
- Media Thickness

Setup item	Setting	Description
User Copy	<1> to 15, ALL When user type is set to 1: <2> to 15, ALL	<ul style="list-style-type: none"> • The setting values of the current user type are copied to the selected user type. • When you have selected ALL, the setting values of the current user type are copied to the all other user types.
	—	<ul style="list-style-type: none"> • [Enter] key: copies the settings and shifts to the previous menu. • [Cancel] key: shifts to the previous menu without copying the settings. <p> 5.1.1.1 User Type menu</p>

5.1.2 Spitting menu

Sets up the spitting operation while printing.

NOTE

- When Spitting is set to “Off”, the nozzle will become easily clogged because spitting is not performed. In this instance, print quality cannot be guaranteed.
- When the spitting setting is “On Media”, the maximum printable media width becomes 10mm shorter.
Therefore, the side margins become “value set on side margin menu” +5mm.
- Depending on the setting, the right margin is a sum of the following.
“Y (print head transferring distance) of the Origin menu” + “5mm (when the spitting setting is “On Media”)” + “value set on side margin menu”

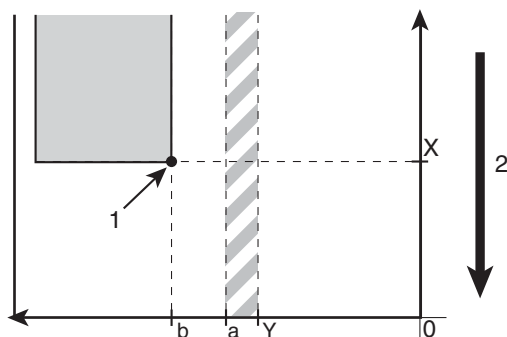

1. Starting position
2. Media feed direction

X (media feeding distance)





Y (print head transferring distance)

a (0mm/5mm: The spitting setting is On, Off/On Media)

b (5mm to 25mm: Side margin setting amount)

[☞ 5.1.3 Side Margin menu](#)

[☞ 5.1.8 Origin menu](#)

Setup item	Setting	Description
Spitting	<On>	Perform the flushing operation on the capping unit located on the origin side for every shuttle. <ul style="list-style-type: none"> [Enter] key: saves the setting and shifts to the sub menu.  5.1 Setup menu
	On Media	Perform the spitting operation on the page margins. The printing speed will be improved since the number of time to return to the capping unit is reduced. <ul style="list-style-type: none"> [Enter] key: saves the setting and shifts to the sub menu.  5.1.2.1 Spitting Pass count menu
	Off	Spitting operation is not performed. <ul style="list-style-type: none"> [Enter] key: saves the setting and shifts to the previous menu.  5.1 Setup menu
	—	<ul style="list-style-type: none"> [Cancel] key: cancels the setting and shifts to the previous menu.  5.1 Setup menu

5.1.2.1 Spitting Pass count menu

Set the frequency (spitting return count) that the print head returns to the capping unit (located) on the origin side when setting “On” or “On Media” in the Spitting menu.

NOTE

- If you set the flushing return count to a high number, the nozzle will become easily clogged when printing for a long time because flushing is not performed over the capping unit.

Setup item	Setting	Description
ReturnCount	<1 time> to 999 times	Set the spitting return count.
	—	<ul style="list-style-type: none"> • [Enter] key: saves the setting and shifts to the previous menu. • [Cancel] key: cancels the setting and shifts to the previous menu.  5.1.2 Spitting menu

<Example of spitting operation>

Spitting setting	Return Count setting	Operation
On	1 time	Performs the spitting operation on the capping unit on the origin side every time the print head returns to the origin position. Spitting is not performed over the media.
On	5 times	Performs the spitting operation on the capping unit on the origin side every five times the print head returns to the origin position. Spitting is not performed over the media.
On Media	1 time	Performs the spitting operation on the capping unit on the origin side every time the print head returns to the origin position. Flushing is performed over the media every time the print head shuttles back and forth.
On Media	5 times	Performs the spitting operation on the capping unit on the origin side every five times the print head returns to the origin position. Flushing is performed over the media every time the print head shuttles back and forth.
Off	—	Spitting is not performed on the capping unit or the media.

5.1.3 Side Margin menu

Set up the right and left margins (side margins) while printing.

NOTE

- When the spitting menu is set to “On Media”, the maximum printable media width becomes 10mm shorter.
Therefore, the side margin becomes “value set on side margin menu” +5mm.
[☞ 5.1.2 Spitting menu](#)
- Depending on the setting, the right margin is a sum of the following.
“Y (print head transferring distance) of the Origin menu” + “5mm (when the spitting setting is “On Media”)” + “value set on side margin menu”

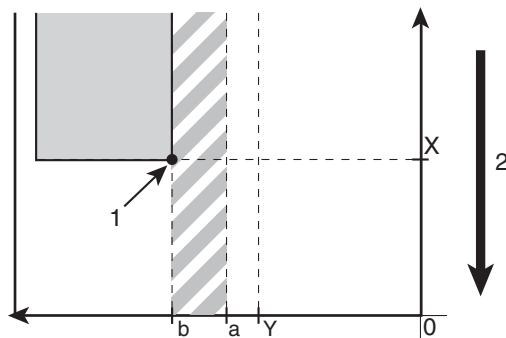

- Starting position
- Media feed direction

X (media feeding distance)

Y (print head transferring distance)

a (0mm/5mm: The spitting setting is On, Off/On Media)

b (5mm to 25mm: Side margin setting amount)

[☞ 5.1.2 Spitting menu](#)

[☞ 5.1.8 Origin menu](#)

Setup item	Setting	Description
Side Margin	<5mm> to 25mm	Set the side margins.
	—	<ul style="list-style-type: none"> [Enter] key: saves the setting and shifts to the previous menu. [Cancel] key: cancels the setting and shifts to the previous menu. ☞ 5.1 Setup menu

5.1.4 Media Initial menu

Sets whether to detect the media width and edge while initializing the media.

NOTE

- Set the media width that is set in the Media Width menu when setting “Off” in the Media detection menu.
 [5.1.5 Media Width menu](#)
- When the Media detection menu is set to “Off”, the media cannot be cut automatically.

Setup item	Setting	Description
Init.	Off	The media is not detected.
	Top & Width	Detect the media width and edge while initializing the media.
	<Width>	Detect the media width while initializing the media.
	—	<ul style="list-style-type: none"> • [Enter] key: saves the setting and shifts to the previous menu. • [Cancel] key: cancels the setting and shifts to the previous menu.  5.1 Setup menu

5.1.5 Media Width menu

Specifies the media width between 7 mm away from the right edge of the platen and the left end if media detection is not performed during media initialization.

 (1) **Media Width menu**

Displays the detected media width if media detection is performed during media initialization.

 (2) **MediaWidth menu**

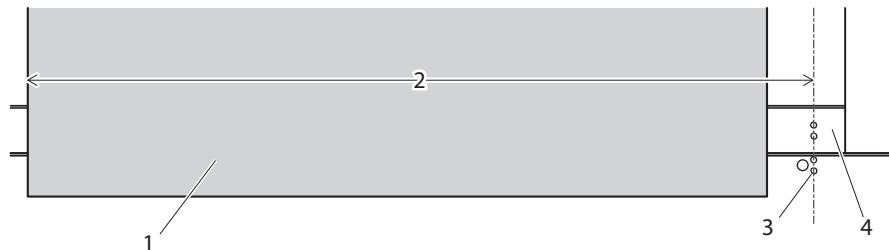

No.	Name
1	Roll media
2	Media width (when not using media detection)
3	Media loading mark
4	Platen

NOTE

- If the media is loaded as shown in the illustration and media detection is not performed, the printing may be performed between the right edge of the platen and the media.

 **5.1.8 Origin menu**

(1) Media Width menu

NOTE

- Setting a larger value than the media width set in the Media Width menu may cause ink to leak on the media or printer.

Setup item	Setting	Description
Media Width	210mm to <1000mm> to 1371mm	Set the media width.
	—	<ul style="list-style-type: none"> • [Enter] key: saves the setting and shifts to the previous menu. • [Cancel] key: cancels the setting and shifts to the previous menu.  5.1.1.1 User Type menu

(2) MediaWidth menu

Setup item	Setting	Description
MediaWidth	**** mm	Display the media width that is detected while initializing.
	—	<ul style="list-style-type: none"> • [Cancel] key: shifts to the previous menu.  5.1 Setup menu

5.1.6 Output Mode menu

Sets the media operation after printing.

NOTE

- When the take-up unit is not installed, do not set output mode to “Take-up”.
By doing so, the product will be unable to function properly.

Setup item	Setting	Description
Output mode	<Off>	Set when not cutting the media automatically after printing. (Set it to Off even when cutting the media manually.) • [Enter] key: saves the setting and shifts to the sub menu. ☞ 5.1.6.1 Ink Drying Time Menu
	Take-up	Set when using the take-up unit. (The media will not be cut after printing.) • [Enter] key: saves the setting and shifts to the sub menu. ☞ 5.1.6.2 Page Gap menu
	Auto Cut	Set when cutting the media automatically. • [Enter] key: saves the setting and shifts to the sub menu. ☞ 5.1.6.1 Ink Drying Time Menu
	—	• [Cancel] key: cancels the setting and shifts to the previous menu. ☞ 5.1 Setup menu

5.1.6.1 Ink Drying Time Menu

This menu is used to set ink drying time.

Setup Item	Setting	Description
Ink drying time	<0sec> to 60min	Set the ink drying time.
	—	• [Enter] key: Saves the set value and shifts to the previous menu. • [Cancel] key: Cancels the setting and shifts to the previous menu. ☞ 5.1.6 Output Mode menu

5.1.6.2 Page Gap menu

If you set the output mode to “Take-up”, the menu shifts to the Page Gap menu.

In the Page Gap menu, you can change the margins between the print results.

Setup item	Setting	Description
Page Gap	<Normal>	Does not change the margin between print results.
	Narrow	The margin between print results becomes narrower than when it is set to “Normal”.
	—	<ul style="list-style-type: none"> • [Enter] key: saves the setting and shifts to the sub menu. ☞ 5.1.6.1 Ink Drying Time Menu • [Cancel] key: cancels the setting and shifts to the previous menu. ☞ 5.1.6 Output Mode menu

5.1.7 Method of Cut menu

Sets the media cutting operation after printing.

NOTE

- When the the media detection is set to “Off”, the media cannot be cut automatically.
- Some media may not be cut (cannot be cut at all or cannot be cut finely). In such a case, set the “Output Mode menu” to “Off” and cut the media manually.

[☞ 5.1.6 Output Mode menu](#)

[☞ 4.4.5 Cutting media manually](#)

- The cutting direction is different depending on the firmware version.

Setup item	Setting	Description
Method of Cut	SingleCut-2 steps	Cuts at a shorter process than SingleCut-3 steps method. Suitable for media with a narrow width.
	<SingleCut-3 steps>	Normal cutting method.
	DoubleCut-2 steps	Set when the media is not cut with SingleCut-2 steps method. Suitable for media with a narrow width.
	DoubleCut-3 steps	Set when the media is not cut with SingleCut-3 steps method.
	—	<ul style="list-style-type: none"> • [Enter] key: saves the setting and shifts to the previous menu. ☞ 5.1.7.1 Cut Pressure menu • [Cancel] key: cancels the setting and shifts to the previous menu. ☞ 5.1 Setup menu

5.1.7.1 Cut Pressure menu

Sets the media cutting pressure for the cutting operation.

Setup item	Setting	Description
Cut Pressure	Low	Cut the media at low pressure. Suitable for thin media or if the “High” pressure setting is too strong.
	<High>	Normal cutting pressure
	-	<ul style="list-style-type: none"> • [Enter] key: saves the setting and return to the previous menu. • [Cancel] Key: Cancel the set value, and return to the previous menu. 🔗 5.1.7 Method of Cut menu

5.1.8 Origin menu

Sets the beginning of printing (origin) of the print data.

Set the menu when reprinting on the margin with changing the printing data position to the printed media.

NOTE

- When output mode menu is set to “Take-up”, the set value X (media feeding distance) becomes 0 mm to 15000 mm.
[🔗 5.1.6 Output Mode menu](#)
- Depending on the set value of the side margin, the maximum set value of Y (print head transferring distance) decreases.
[🔗 5.1.3 Side Margin menu](#)

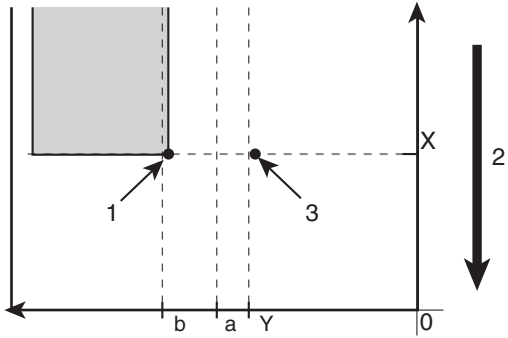
Setup item	Setting	Description
Origin	<ul style="list-style-type: none"> • X (media feeding distance): -15000 mm to 15000 mm • Y (print head transferring distance): 0 mm to 1151 mm 	<p>Change the print head position and media feeding distance with the following keys.</p> <ul style="list-style-type: none"> • [>] key: Decreases the print head transferring distance • [<] key: Increases the print head transferring distance • [+] key: Increase the media feeding distance. • [-] key: Decrease the media feeding distance.  <p>1. Starting position 2. Media feeding direction 3. Setting position of "Origin menu"</p> <p>X (media feeding distance) Y (print head transferring distance) a (0mm/5mm: The spitting setting is On, Off/On Media) b (5mm to 25mm: Side margin setting amount)</p> <p>NOTE</p> <ul style="list-style-type: none"> • Depending on the setting, the right margin is a sum of the following. "Y (print head transferring distance) of the Origin menu" + "5mm (when the spitting setting is "On Media")" + "value set on side margin menu" <p>☞ 5.1.2 Spitting menu ☞ 5.1.3 Side Margin menu</p>
Confirm Position -> Enter		<ul style="list-style-type: none"> • [Enter] key or after a certain period of time: Determines the setting. Print head returns to the original position. Save the setting and shift to the previous menu. ☞ 5.1 Setup menu
—		<ul style="list-style-type: none"> • [Cancel] key: cancels the setting and shifts to the previous menu. ☞ 5.1 Setup menu

5.1.9 Head Travel menu

Sets up the range that the print head moves while printing.

Setup item	Setting	Description
Distance	<Data>	The print head moves the range of the print data width. The printing speed will be improved since the moving range of the print head is optimized.
	Machine	The print head moves from origin to the maximum printable media width.
	<Media Width>	The print head moves the range of the media width.
	—	<ul style="list-style-type: none"> • [Enter] key: saves the setting and shifts to the previous menu. • [Cancel] key: cancels the setting and shifts to the previous menu.  5.1 Setup menu

NOTE

- The minimum travel range of the printer's CR is 500mm.
- Note that even when the media with a width that is below 500mm is loaded while the printer is set to "Data" or "Media Width", the actual CR travel range does not go below 500mm.

5.1.10 Multi Strike menu

Sets up the overwrite count per line.

Setup item	Setting	Description
Multi Strike	<1 time> to 9 times	Set the overwrite count.
	—	<ul style="list-style-type: none"> • [Enter] key: saves the setting and shifts to the previous menu. • [Cancel] key: cancels the setting and shifts to the previous menu.  5.1 Setup menu

5.1.11 Strike Wait menu

Sets up the waiting time while overwrite printing.

Setup item	Setting	Description
Strike Wait	<0.0 sec.> to 0.1 sec. to 5.0 sec.	Sets the overwrite wait time.
	—	<ul style="list-style-type: none"> • [Enter] key: saves the setting and shifts to the previous menu. • [Cancel] key: cancels the setting and shifts to the previous menu.  5.1 Setup menu

5.1.12 Slant Check menu

Sets up slanting detection during media loading.

Setup item	Setting	Description
Slant Check	Off	Slant Check is not performed.
	<On>	Slant Check is performed.
	—	<ul style="list-style-type: none"> • [Enter] key: saves the setting and shifts to the previous menu. • [Cancel] key: cancels the setting and shifts to the previous menu.  5.1 Setup menu

5.1.13 Auto Cleaning menu

Configure the settings for the auto-cleaning operation.

TIP

•The cleaning mode reflects the settings in the operation panel.

☞ [6.2.3 Head cleaning](#)

Setup item	Setting	Description
Auto Cleaning	Standby Mode	Set the value for auto-cleaning while standby. ☞ 5.1.13.1 Standby Mode Auto Cleaning
	While Printing	Set the value for auto-cleaning while printing. ☞ 5.1.13.2 While Printing Auto Cleaning
	Before print	Set the value for auto-cleaning before printing. ☞ 5.1.13.3 Before Print Auto Cleaning
	—	<ul style="list-style-type: none"> • [Enter] key: saves the setting and shifts to the sub menu. • [Cancel] key: shifts to the previous menu. ☞ 5.1 Setup menu



5.1.13.1 Standby Mode Auto Cleaning

Set the auto cleaning interval while standby.

Setup item	Setting	Description
WaitingTime	Off / 10 mins to <360 mins> to 1440 mins	Sets the timer for auto-cleaning in Standby Mode. <ul style="list-style-type: none"> • Off: Auto cleaning is not performed. • Others: The head cleaning selected in Cleaning menu will be performed automatically by the timer specified here. ☞ 6.2.3 Head cleaning
	—	<ul style="list-style-type: none"> • [Enter] key: saves the setting and shifts to the previous menu. • [Cancel] key: cancels the setting and shifts to the previous menu. ☞ 5.1.13 Auto Cleaning menu



5.1.13.2 While Printing Auto Cleaning

Set the auto cleaning timer to be performed while printing.

Setup item	Setting	Description
PrintingTime	<Off> / 5 mins to 180 mins	Selects the time for auto-cleaning while printing. <ul style="list-style-type: none"> • Off: Auto cleaning is not performed. • Others: The head cleaning selected in Cleaning menu will be performed automatically by the timer specified here.  6.2.3 Head cleaning
	—	<ul style="list-style-type: none"> • [Enter] key: saves the setting and shifts to the previous menu. • [Cancel] key: cancels the setting and shifts to the previous menu.  5.1.13 Auto Cleaning menu

5.1.13.3 Before Print Auto Cleaning

Sets whether to perform auto cleaning before printing.

Setup item	Setting	Description
Before Print	<Off>	The auto cleaning is not performed.
	On	<ul style="list-style-type: none"> • The head cleaning selected in Cleaning menu will be performed automatically before printing.  6.2.3 Head cleaning
	—	<ul style="list-style-type: none"> • [Enter] key: saves the setting and shifts to the previous menu. • [Cancel] key: cancels the setting and shifts to the previous menu.  5.1.13 Auto Cleaning menu

5.1.14 Longstore menu

Wash the print head with the cleaning fluid.

NOTE



- Make sure to use the dedicated cleaning fluid (Model number: RJ-FGCLS, VJ-AQU-CL600U).

Setup item	Setting	Description
Longstore	Start	Wash the print head with the cleaning fluid. <ul style="list-style-type: none"> • [Enter] key: Performs the head washing operation. The following content is displayed on the operation panel. ☞ 6.5.1 Long-term storage
	Remove Cartridges	Remove the ink cartridge, and install the cleaning cartridge. ☞ 6.1.1 Replacing ink
	—	<ul style="list-style-type: none"> • [Cancel] key: shifts to the previous menu without Head washing. ☞ 5.1 Setup menu

5.1.15 CR Maintenance menu

Performs maintenance.

Used in the following cases.

- Cleaning the cleaning wiper
 [6.2.4 Cleaning the cleaning wiper](#)
- Cleaning around the print head
 [6.2.6 Cleaning around the print head](#)
- Replacing Cutter
 [6.1.3 Replacing Cutter](#)

Setup item	Setting	Description
CR Maintenance	Start	Performs maintenance. <ul style="list-style-type: none"> • [Enter] key: Print head moves to the left. Cleaning wiper rises.
		The following content is displayed on operation panel. “CR Maint.: End” <ul style="list-style-type: none"> • [Enter] key: Cleaning wiper returns to the original position. Print head returns to the original position.
	—	<ul style="list-style-type: none"> • [Cancel] key: shifts to the previous menu without maintenance.  5.1 Setup menu
	—	<ul style="list-style-type: none"> • Perform the pumping operation (start/stop) by pressing the “-” key while displaying “CR Maint.: End”.

5.1.16 Initialization menu

Returns the settings of the printer to default.

Setup item	Setting	Description
Initialization	ALL	All settings can be returned to factory default.
	User Type	The setting of the User Type is returned to factory default.
	Except User Type	The setting other than the User Type is returned to factory default.
	—	<ul style="list-style-type: none"> • [Enter] key: “Initial. Parameter? No” is displayed on the operation panel. Select “Yes”, then press [Enter] key, and the printer initializes the setting. • [Cancel] key: shifts to the previous menu without initialization.  5.1 Setup menu

5.1.17 IP Address menu

Sets the IP address of the printer.

NOTE

- Be sure to set the IP address after consulting the network administrator.

Setup item	Setting	Description
IP Address	000.000.000.000 to <192.168.001.253> to 255.255.255.255	Change the IP address by operating the following keys. <ul style="list-style-type: none"> • [+] key: increases the setting value. • [-] key: decreases the setting value. • [Enter] key: changes the setting for the next segment.
	—	<ul style="list-style-type: none"> • [Cancel] key: saves the setting and shifts to the previous menu.  5.1 Setup menu

5.1.18 Subnet Mask menu

Sets the subnet mask of the printer.

NOTE

- Be sure to set the subnet mask after consulting the network administrator.

Setup item	Setting	Description
Subnet Mask	000.000.000.000 to <255.255.255.000> to 255.255.255.255	Change the subnet mask by operating the following keys. <ul style="list-style-type: none"> • [+] key: increases the setting value. • [-] key: decreases the setting value. • [Enter] key: changes the setting for the next segment. In the 4th segment, it saves the setting and shifts to the previous menu.
	—	<ul style="list-style-type: none"> • [Cancel] key: cancels the setting and shifts to the previous menu.  5.1 Setup menu

5.1.19 Gateway menu

Sets the gateway.

NOTE

- Be sure to set the gateway after consulting the network administrator.

Setup item	Setting	Description
Gateway	000.000.000.000 to <192.168.001.254> to 255.255.255.255	Change the gateway by operating the following keys. <ul style="list-style-type: none"> • [+] key: increases the setting value. • [-] key: decreases the setting value. • [Enter] key: changes the setting for the next segment. In the 4th segment, it saves the setting and shifts to the previous menu.
	—	<ul style="list-style-type: none"> • [Cancel] key: cancels the setting and shifts to the previous menu. 🔍 5.1 Setup menu

5.1.20 Header Dump menu

This function is to specify whether to print the following information (dump data) of print data.

- Data header
- Data dot number (printed only when Header dump setting is “On”)
- Printing date and time
- Printer serial number
- Firmware version
- Receiving time (printed only when Header dump setting is “Dump”)
- Receiving size (printed only when Header dump setting is “Dump”)

NOTE

- The dump data will be used as a reference material to receive technical supports.

TIP

When a print is executed in connection with computer, the setting of RIP software will be printed in the “Data Header”.

Setup Item	Set Value	Description
Header Dump	<Off>	<ul style="list-style-type: none"> • Only a print data will be printed. • Dump data will not be printed.
	On	After printing of print data, the dump data will be printed.
	Dump	<ul style="list-style-type: none"> • Only a dump data will be printed, but the “Number of Dot in Data” will not be printed. • Print data will not be printed.
	Print	Prints the last header dump. If no history is available, “No Print Data” will appear on the operation panel.
	—	<ul style="list-style-type: none"> • [Enter] key: saves the setting and shifts to the previous menu. • [Cancel] key: cancels the setting and shifts to the previous menu.  5.1 Setup menu

5.1.21 Start Feed Menu

If you set the start feed beforehand, you can change the margins between the print results.

Setup Item	Description	Setup Item
Start Feed	-10 mm to <0 mm> to 500 mm	<ul style="list-style-type: none"> When the value is bigger than 0: the margins are bigger than when it is set to "0". When the value is 0: the margin between print results does not change. When the value is smaller than 0: the margins are smaller than when it is set to "0".
	—	<ul style="list-style-type: none"> [Enter] key: saves the setting and shifts to the previous menu. [Cancel] key: cancels the setting and shifts to the previous menu. 🔗 5.1 Setup menu

NOTE

- When using the take-up device and setting the "Start Feed" as less than 0, set the "Page Gap" as "Narrow". If it is set as "Normal", the settings for "Start Feed" is not applied correctly.

[🔗 5.1.6.2 Page Gap menu](#)

5.1.22 Alert Buzzer menu

Selects how to turn off the printer beep sound when an error occurs.

For unattended printing, you can select "Off" setting to avoid continuous buzzer beep.

Setup item	Setting	Description
Alert Buzzer	<On>	Press any key on operation panel to turn off beep sound. This is the initially set value.
	Off	After several beeps, the printer automatically turns off beep sound.
	—	<ul style="list-style-type: none"> [Enter] key: saves the setting and shifts to the previous menu. [Cancel] key: cancels the setting and shifts to the previous menu. 🔗 5.1 Setup menu

5.1.23 Front Interlace Menu

This menu is used to set media edge treatment menu. Select Auto under normal condition.

Setup item	Setting	Description
FrontInterlace	<Auto>	Performs media edge treatment automatically when required.
	Off	Media edge treatment is not performed.
	—	<ul style="list-style-type: none"> • [Enter] key: saves the setting and shifts to the previous menu. • [Cancel] key: shifts to the previous menu. 🔗 5.1 Setup menu

NOTE

To set Paper Interlace OFF, set the “FrontInterlace” setting value as ON (display) in the Menu Option menu, and then change the set values of “FrontInterlace” from the Setup menu.

[🔗 5.4 Menu Option menu](#)

5.1.24 Select Nozzle menu

If missing lines still persist after several attempts of cleaning, you can check the nozzle conditions by printing the select nozzle patterns and choose only good nozzles for printing.

Setup item	Setting	Description
Select Nozzle	Print	Print the select nozzle patterns and find the pattern that does not have missing lines. <ul style="list-style-type: none"> • [Enter] key: “Printing” is displayed on the operation panel and Print the select nozzle patterns starts.
	Settings	Goes to the nozzle settings menu. <ul style="list-style-type: none"> • [Enter] key: shifts to the sub menu. ☞ 5.1.24.1 Nozzle Settings menu
	—	<ul style="list-style-type: none"> • [Cancel] key: cancels the setting value and shifts to the previous menu. ☞ 5.1 Setup menu

5.1.24.1 Nozzle Settings menu

Setup item	Setting	Description
Settings	Nozzle ALL	Using all of the nozzles on the print head.
	Nozzle Ato F	Choose from A to F for the pattern that does not have missing lines.
	—	<ul style="list-style-type: none"> • [Enter] key: saves the setting and shifts to the previous menu. • [Cancel] key: cancels the setting value and shifts to the previous menu. ☞ 5.1 Setup menu

5.2 Test Print Menu

Performs nozzle check of the print head and setup list.

NOTE

When the selected print mode of the user type is Production, Palette menu is not displayed.

☞ [5.1.1.1.1 Print Mode menu](#)

TIP

•Refer to the following for the operation procedure of test print.

☞ [3.5 Test print](#)

Setup item	Description
Nozzle Check	Perform the nozzle check printing. It is used to check whether there are any clogged heads, or missing or blurred prints. ☞ 3.5.1 Nozzle check Print a nozzle check pattern selected from Nozzle setting menu. ☞ 5.1.24.1 Nozzle Settings menu
Nozzle Check	Perform the nozzle check printing. It is used to check whether there are any clogged heads, or missing or blurred prints. ☞ 3.5.2 Nozzle check F Print a nozzle check pattern using all of the nozzles on the print head.
Mode Print	Mode print can be performed. Used to confirm the following printing conditions. <ul style="list-style-type: none"> • Print quality • Effect • Adjustment value ☞ 3.5.3 Mode print
Setup List	Setup list printing is performed. Used to check the setup item and the user type. ☞ 3.5.4 Setup print
Palette	Palette print is executed for the color demonstration. ☞ 3.5.5 Palette print
—	<ul style="list-style-type: none"> • [Enter] key: “Printing” is displayed on the operation panel and test printing starts. • [Cancel] key: shifts to the previous menu. ☞ 5 Panel setup menu



5.3 Cleaning menu

Performs head cleaning.

TIP

- Head cleaning can be operated when the printer is Normal.
- Refer to the following for operation procedures.

 [6.2.3 Head cleaning](#)

Setup item	Description
Short	Discharges smaller amount of ink compared to “Normal”.
Normal	Select this mode normally.
Long	Discharges larger amount of ink compare to “Normal”. Used when the print head does not improve by normal Head cleaning.
Little Charge	Discharges larger amount of ink compare to “Long”. Charge a small amount of ink when printing is not stable after initial ink charge.  3.3 Installing ink
Initial Charge	Perform this when using the high capacity pack adapter for the first time, for the printer whose ink is charged.  3.3.3 When using the high capacity pack adapters for the first time on the printer that ink has already been filled
—	<ul style="list-style-type: none"> • [Enter] key: “Cleaning **%” is displayed on the operation panel and Head cleaning starts. Progress on the Head cleaning is displayed in % on the operation panel. • [Cancel] key: shifts to the previous menu.  5 Panel setup menu

5.4 Menu Option menu

Sets up the contents of the Setup menu.

You can make setup items that you do not normally use invisible.

Switch the setting “On (displayed)” to “Off (undisplayed)” using the [<] key or [>] key on the operation panel.

When the setting is On, “*” is displayed on the operation panel.

NOTE

- Even if you select “Off” in the Menu Option menu, you can display the settings temporarily by selecting “Temporary” in the Setup menu.



 [5.1 Setup menu](#)

Setup item	Setting	Description
User Type	Off	Sets up whether to display the User Type menu.
	<On>	
Spitting	Off	Sets up whether to display the Spitting menu.
	<On>	
Side Margin	Off	Sets up whether to display the Side Margin menu.
	<On>	
Media Initial	Off	Sets up whether to display the Media Initial menu.
	<On>	
MediaWidth	Off	Sets up whether to display the MediaWidth menu.
	<On>	
Output Mode	Off	Sets up whether to display the Output Mode menu.
	<On>	
Method of Cut	Off	Sets up whether to display the Method of Cut menu.
	<On>	
Origin	Off	Sets up whether to display the Origin menu.
	<On>	
Prev. Stick	<Off>	This menu is invalid.
Standby Heating	<Off>	This menu is invalid.
Head Travel	Off	Sets up whether to display the Head Travel menu.
	<On>	
Multi Strike	Off	Sets up whether to display the Multi Strike menu.
	<On>	
Strike Wait	Off	Sets up whether to display the Strike Wait menu.
	<On>	

Setup item	Setting	Description
Slant Check	Off	Sets up whether to display the Slant Check menu.
	<On>	
Auto Cleaning	Off	Sets up whether to display the Auto Cleaning menu.
	<On>	
Longstore	Off	Sets up whether to display the Longstore menu.
	<On>	
CR Maintenance	Off	Sets up whether to display the CR Maint. menu.
	<On>	
Initialization	Off	Sets up whether to display the Initialization menu.
	<On>	
IP Address	Off	Sets up whether to display the IP Address menu.
	<On>	
Subnet Mask	Off	Sets up whether to display the subnet mask.
	<On>	
Gateway	Off	Sets up whether to display the Gateway menu.
	<On>	
Header dump	Off	Specify whether to display the header dump menu.
	<On>	
Start Feed	Off	Sets up whether or not to display the Start Feed menu
	<On>	
Alert Buzzer	Off	Set whether or not to display the Alert Buzzer menu.
	<On>	
FrontInterlace	Off	Sets up whether to display the FrontInterlace menu.
	<On>	
Select Nozzle	Off	Sets up whether to display the Select Nozzle menu.
	<On>	
ALL On		Displays all items in the Setup menu. <ul style="list-style-type: none"> Pressing the [Enter] key displays "*" for all items in the Menu Option menu.
ALL Off		No items in the Setup menu are displayed. <ul style="list-style-type: none"> Pressing the [Enter] key deletes "*" for all items in the Menu Option menu. Even if you select "ALL Off", you can display the items temporarily by selecting "Temporary" in the Setup menu.
—		<ul style="list-style-type: none"> [Cancel] key: saves the setting and shifts to the previous menu.  5 Panel setup menu

5.5 System Information menu

Display the system information on your printer.



Setup item	Setting	Description
Ver.	*.**	Displays the versions of the firmware.
Model	*****	Displays the model name of your printer.
Serial	*****	Displays your printer's serial number.
Ink Type	*****	Displays the ink type being used on your printer.
T. Area	*****m2	Displays total printed area in the printer since the purchase. This information may be used for reference for maintenance.
Ink Status	—	Displays the various information (ink status) about ink cartridges that are installed in the slots and information about Smart/C. <ul style="list-style-type: none"> [Enter] key: shifts to the sub menu.  5.5.1 Ink Status menu
Life Times	—	Displays the operational life time of each part. <ul style="list-style-type: none"> [Enter] key: shifts to the sub menu.  5.5.2 Life Times menu
	—	<ul style="list-style-type: none"> [Cancel] key: shifts to the previous menu.  5 Panel setup menu

5.5.1 Ink Status menu

Displays the various information of smart chips.

NOTE

- To display the various information of Smart chips, use genuine ink and S/C cards. If ink other than genuine ink is used, the ink status will not be displayed correctly.

Setup item	Setting	Description
KCMY	0 to 100 (unit: %)	The amount of ink remaining in each ink of K/C/M/Y is displayed. <ul style="list-style-type: none"> If it is blinking at 10%, smartchip recovery is being performed on the corresponding slot.  7.4 Smartchip Recovery
	—	<ul style="list-style-type: none"> [Cancel] key: shifts to the previous menu.  5.1 Setup menu

5.5.2 Life Times menu

Displays the operational life time of each part.

Setup item	Setting	Description
Head	E*****F	Display the operational life of each part. •The lifetime of each part is indicated by the asterisks (Maximum 5 asterisks: 100% left). • As the part deteriorates, the number of asterisks decreases one by one (20 %). • The part should be changed when all of the asterisks have disappeared, and “Change” is displayed. Contact your local MUTOH dealer to ask for replacing parts.
Pump	E*****F	
CR Motor	E*****F	
PF Motor	E*****F	
	—	• [Cancel] key: shifts to the previous menu. 🔑 5.1 Setup menu

5.6 Sleep Mode menu

Sleep mode settings are configured.

When you activate sleep mode, the printer operates as follows.

- The vacuum fan stops.
- All heaters stop.
- All lamps turn off except for the power lamp.
- Automatic head cleaning is performed after the time set in the Cleaning Mode menu has elapsed.

🔑 [5.6.1 Sleep Mode Cleaning Mode menu](#)

TIP

- The cleaning mode reflects the settings in the operation panel.

🔑 [6.2.3 Head cleaning](#)

Setup item	Setting	Description
Sleep Mode	Cleaning Mode	Set the auto cleaning interval for Sleep Mode. 🔑 5.6.1 Sleep Mode Cleaning Mode menu
	Start	Activate Sleep Mode 🔑 5.6.2 Sleep Mode Start menu
	—	• [Cancel] key: shifts to the previous menu. 🔑 5.1 Setup menu

5.6.1 Sleep Mode Cleaning Mode menu

Set the head cleaning interval of this printer for Sleep Mode.

When more than the set time has passed, the print head is cleaned automatically.

NOTE

- During Sleep Mode, even if the set amount of time has passed, print-head cleaning is not performed under the following circumstances.
- The front cover is open.
- Maintenance cover is open.
- The media loading lever is pushed towards the back.
- The waste fluid tank is full.
- Ink is low (or no ink).
- The ink cartridge (or high-capacity ink pack adapter) has been removed.
- An object other than an appropriate ink cartridge is inserted in the cartridge slot, etc.

When the printer returns to a normal state, head cleaning is restarted, and Sleep Mode continues.

☞ [7.2 Error messages](#)

- If one of the above conditions occurs during head cleaning, cleaning is stopped.
- When the printer returns to a normal state, head cleaning is restarted.

☞ [7.2 Error messages](#)

Setup item	Setting	Description
Cleaning Timer	1 / 2 / 3 / 4 / 5 / <6> / 9 / 12 / 18 / 24h	When the set time has elapsed, the head cleaning starts.
	—	<ul style="list-style-type: none"> • [Cancel] key: shifts to the previous menu. ☞ 5.6 Sleep Mode menu

5.6.2 Sleep Mode Start menu

Activate Sleep Mode

During Sleep Mode, “Restart → Enter” will be displayed in the operation panel.

During Sleep Mode, pressing [Enter] key will return the printer to normal operation.

NOTE

- If the printer is under one of the following conditions while shifting to the Sleep Mode, “Don’t Start Sleep Mode” is displayed, and will not shift to the Sleep Mode.
 - The front cover is open.
 - Maintenance cover is open.
 - The media loading lever is pushed towards the back.
 - The waste fluid tank is full.
 - Ink is low (or no ink).
 - The ink cartridge (or high-capacity ink pack adapter) has been removed.
 - An object other than an appropriate ink cartridge is inserted in the cartridge slot, etc.

Activate Sleep Mode again after returning the printer to a normal state.

 [7.2 Error messages](#)

- If the printer is under one of the conditions above during the Sleep mode, the printer will not return to the Normal condition even pressing the [Enter] key.
Return the printer to a normal state, and press the [Enter] key to return the printer to normal operation.

 [7.2 Error messages](#)

Setup item	Setting	Description
Start	Start Sleep Mode?	<ul style="list-style-type: none"> • [Enter] key: activates Sleep Mode. • [Cancel] key: shifts to the previous menu without activating Sleep Mode.  5.6 Sleep Mode menu
	Restart -> Enter	The printer is in Sleep Mode. <ul style="list-style-type: none"> • [Enter] key: return the printer to normal operation.

5.7 Display menu

Sets the language and unit displayed on the LCD monitor of the operation panel.

Setup item	Setting	Description
Display	Language	Sets the language used in the menu items displayed on the LCD monitor of the operation panel. ☞ 5.7.1 Language menu
	Temperature	Sets the unit of temperature display. ☞ 5.7.2 Temperature menu
	Length	Sets the unit to display the length. ☞ 5.7.3 Length menu
	Remain Ink	Sets whether to display the ink level indicator. ☞ 5.7.4 Remain Ink menu
	—	<ul style="list-style-type: none"> [Cancel] key: shifts to the previous menu. ☞ 5 Panel setup menu

5.7.1 Language menu

Sets the language used in the menu items displayed on the LCD monitor of the operation panel.

Setup item	Setting	Description
Language	<English>	Displays the menu items in English.
	Japanese	Displays the menu items in Japanese.
	—	<ul style="list-style-type: none"> [Enter] key: saves the setting and shifts to the previous menu. [Cancel] key: cancels the setting and shifts to the previous menu. ☞ 5.7 Display menu

5.7.2 Temperature menu

Sets the unit of temperature display.

Setup item	Setting	Description
Temperature	<Celsius [°C]>	Displays the temperature in Celsius [°C].
	Fahrenheit [°F]	Displays the temperature in Fahrenheit [°F].
	—	<ul style="list-style-type: none"> [Enter] key: saves the setting and shifts to the previous menu. [Cancel] key: cancels the setting and shifts to the previous menu. ☞ 5.7 Display menu

5.7.3 Length menu

Sets the unit to display the length.

Setup item	Setting	Description
Length	<mm>	Displays the length in millimeters (mm).
	inch	Displays the length in inches (inch).
	—	<ul style="list-style-type: none"> • [Enter] key: saves the setting and shifts to the previous menu. • [Cancel] key: cancels the setting and shifts to the previous menu. ☞ 5.7 Display menu

5.7.4 Remain Ink menu

Sets whether to display the ink level indicator.

Setup item	Setting	Description
Remain Ink	On	Displays the ink level indicator. Refer to the following for the details. ☞ 2.1.4 Ink level indicator ☞ 2.1.4.1 Ink level indicator
	<Off>	The ink level indicator is not displayed.
	—	<ul style="list-style-type: none"> • [Enter] key: saves the setting and shifts to the previous menu. • [Cancel] key: cancels the setting and shifts to the previous menu. ☞ 5.7 Display menu

5.8 Job Status Menu

Various information of previous print will be displayed.

The length of printed data and if the print is completed will be displayed. When the print is canceled, the information how much the print is completed will be displayed.

Setup item	Setting	Description
Job Status	JobStatus	Displays if the print is completed. <ul style="list-style-type: none"> • When the print is completed: “Completed” • When the print is canceled: “Canceled”
	ToDoLength	The total length of print data (media feeding direction) will be displayed.
	Done	The printed length will be displayed.
	Remain	The remaining length of print data will be displayed.
	—	<ul style="list-style-type: none"> • [Cancel] key: cancels the setting and shifts to the previous menu. 🔑 5 Panel setup menu







TIP

- This function is to check the information of print data with the print operation is completed. For the details on data while printing, please refer to the below.
 - 🔑 [4.4.6.2 Settings that can be changed or confirmed while printing](#)
 - 🔑 [4.4.8 Normal Display while Printing](#)
- The values displayed in this function are just standard values, not guarantee the accuracy.
- If the print data includes no length data, all information will be displayed as “0”.

5.9 Roll Length Manage menu

Before replacing with another roll media, you can print the remaining roll length information on the roll media.

This information can be printed with a code that your printer can read. The next time when the roll media is loaded, your printer will read the code and will automatically specify the Roll Length settings.

Setup item	Setting	Description
Roll Length Manage	Print	Print the remaining length management information with text and code on the roll media. <ul style="list-style-type: none"> • [Enter] key: “Cut Media? No” is displayed on the operation panel. Select “Yes” or “No”, then press [Enter] key, and print starts.  5.9.1 Print menu
	Simple Print	Print the remaining length management information with text only on the roll media. <ul style="list-style-type: none"> • [Enter] key: “Cut Media? No” is displayed on the operation panel. Select “Yes” or “No”, then press [Enter] key, and print starts.  5.9.2 Simple Print menu
	Scan	Your printer can scan the remaining length management code that was printed on a roll media with "Print". <ul style="list-style-type: none"> • [Enter] key: “Please wait” is displayed on the operation panel, then scan starts.  5.9.3 Scan menu
	Roll Length	Sets up the roll media length. <ul style="list-style-type: none"> • [Enter] key: shifts to the sub menu.  5.9.4 Roll Length menu
	Auto Scan	Goes to the auto scan menu. <ul style="list-style-type: none"> • [Enter] key: shifts to the sub menu.  5.9.5 Auto Scan menu
	Auto Print	This option can shorten the steps to print a remaining length management code after performing media cutting. <ul style="list-style-type: none"> • [Enter] key: shifts to the sub menu.  5.9.6 Auto Print menu
	—	<ul style="list-style-type: none"> • [Cancel] key: cancels the setting and shifts to the previous menu.  5.1 Setup menu

NOTE

- The Roll Length Manage menu will not be displayed if "Media Initial" is set to "Off".
 ↳ [5.1.4 Media Initial menu](#)
- The Roll Length Manage menu will not be displayed if the media is not loaded.

5.9.1 Print menu

Follow the procedure below to print.

1. Turn ON the printer and load the media.
 ↳ [3.4.2 Loading a roll media into the printer](#)
2. Go to the Roll Length Manage menu on the operation panel.
 - a. Press the [Menu] key on the operation panel.

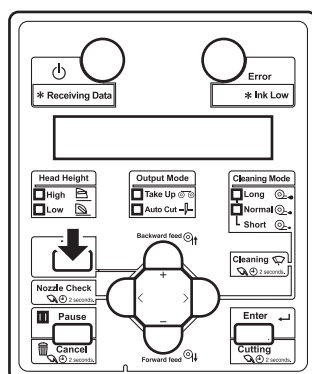

- “Menu 1: Setup>” is displayed on the operation panel.
 - The operation panel shifts to the Setup menu display.
- b. Press the [+] key or [-] key to select “Menu9: RollLengthMan>”.

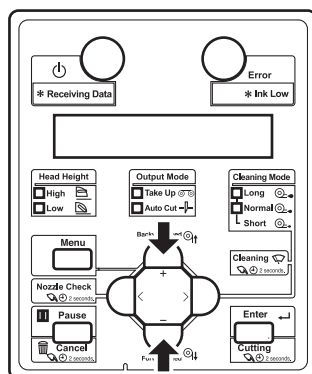

- c. Press the [>] key on the operation panel.

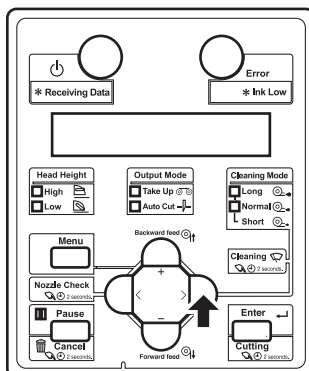

- “Roll1: Print” is displayed on the operation panel.

- d. Press the [Enter] key on the operation panel.

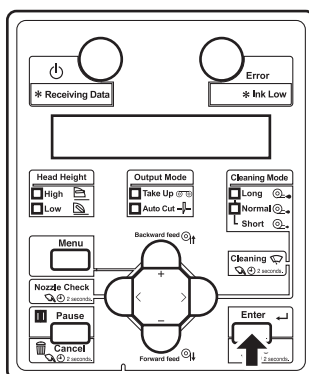

- “Cut Media? No” is displayed on the operation panel.

NOTE

- If you want to cut the media, press the [+] key or [-] key to select “Yes”, then press [Enter] key.

- e. Press the [Enter] key on the operation panel.

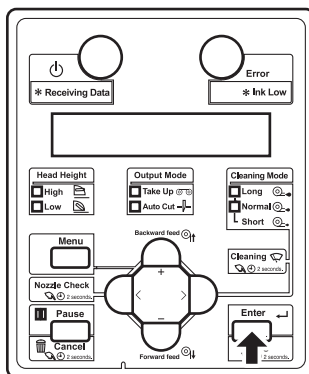

- “Printing” is displayed on the operation panel, then start printing.

NOTE

- The printer is unable to print this information if "Roll Length" is set to "Off".
↳ [5.9.4 Roll Length menu](#)
- This menu will print the following information:
 - Type of roll media
 - Remaining roll length
 - Date printed
 - Remaining length management code



- "Roll 1: Print" or "Roll 2: Simple Print" requires at least 400 mm printable width. Before printing, make sure that there is sufficient width on the media.
If printable width is less than 400 mm, your printer will not perform printing. Printable width on the media can be adjusted by changing CR origin and side margin (left and right side margin) settings.
↳ [5.1.3 Side Margin menu](#), [5.1.5 Media Width menu](#), [5.1.8 Origin menu](#)

5.9.2 Simple Print menu

Follow the procedure below to simple print.

1. Turn ON the printer and load the media.
 - [3.4.2 Loading a roll media into the printer](#)
2. Go to the Roll Length Manage menu on the operation panel.
 - a. Press the [Menu] key on the operation panel.

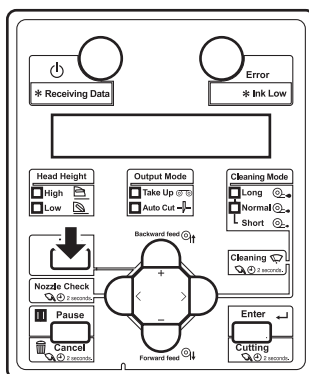

- “Menu 1: Setup>” is displayed on the operation panel.
 - The operation panel shifts to the Setup menu display.
- b. Press the [+] key or [-] key to select “Menu9: RollLengthMan>”.

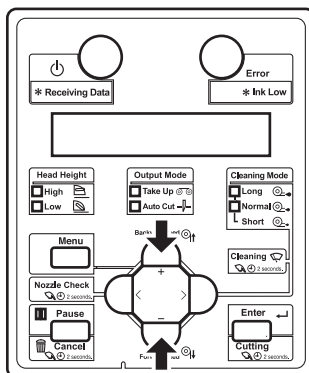

c. Press the [>] key on the operation panel.

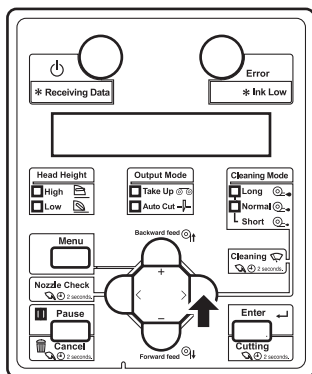

- “Roll1: Print” is displayed on the operation panel.

d. Press the [+] key or [-] key to select “Roll2: Simple Print”.

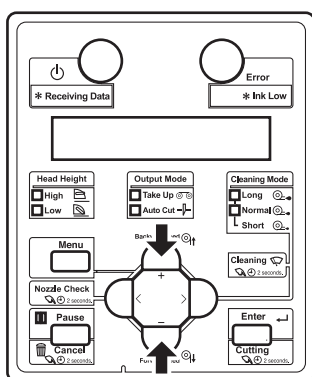

e. Press the [Enter] key on the operation panel.

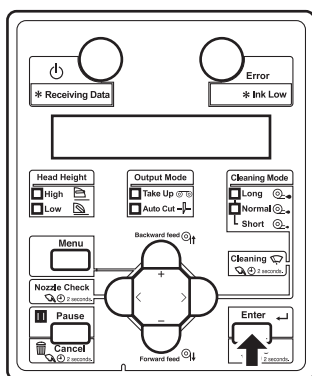

- “Cut Media? No” is displayed on the operation panel.

NOTE

- If you want to cut the media, press the [+] key or [-] key to select “Yes”, then press [Enter] key.

- f. Press the [Enter] key on the operation panel.

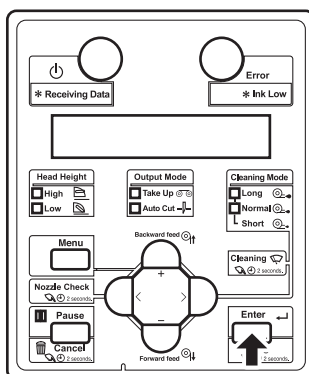

- “Printing” is displayed on the operation panel, then start printing.

NOTE

- The printer is unable to print this information if "Roll Length" is set to "Off".
[🔗 5.9.4 Roll Length menu](#)
- This menu will print the following information:
 - Type of roll media
 - Remaining roll length
 - Date printed

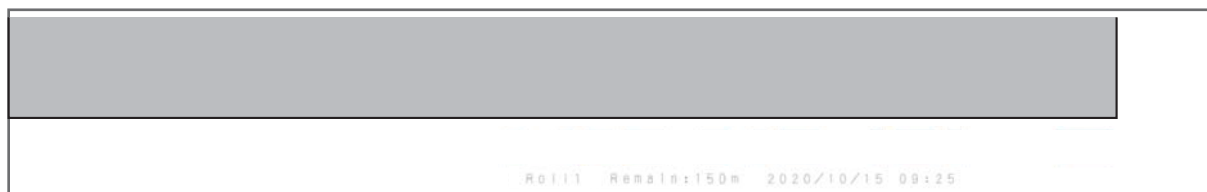

- "Roll 1: Print" or "Roll 2: Simple Print" requires at least 400 mm printable width. Before printing, make sure that there is sufficient width on the media. If printable width is less than 400 mm, your printer will not perform printing. Printable width on the media can be adjusted by changing CR origin and side margin (left and right side margin) settings.
[🔗 5.1.3 Side Margin menu](#), [5.1.5 Media Width menu](#), [5.1.8 Origin menu](#)

5.9.3 Scan menu

Follow the procedure below to scan the remaining length management code.

1. Turn ON the printer and load the media that the remaining length management code has been printed on it.

3.4.2 Loading a roll media into the printer

- Check that the code printed on the media has passed through the pressurizing rollers.
2. Go to the Roll Length Manage menu on the operation panel.
 - a. Press the [Menu] key on the operation panel.

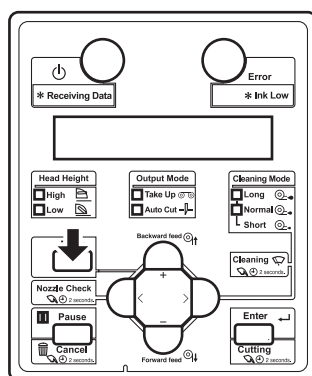

- “Menu 1: Setup>” is displayed on the operation panel.
 - The operation panel shifts to the Setup menu display.
- b. Press the [+] key or [-] key to select “Menu9: RollLengthMan>”.

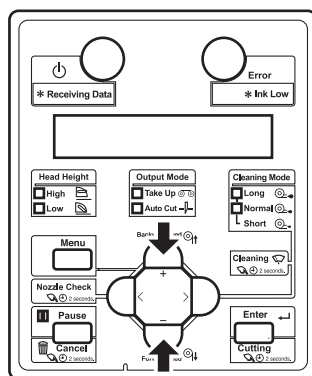

- c. Press the [>] key on the operation panel.

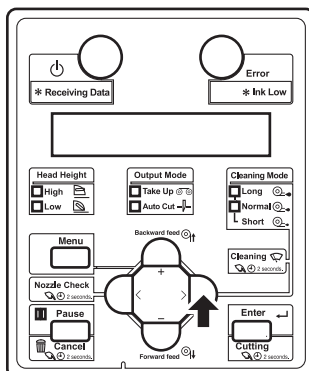

- “Roll1: Print” is displayed on the operation panel.

- d. Press the [+] key or [-] key to select “Roll3: Scan”.

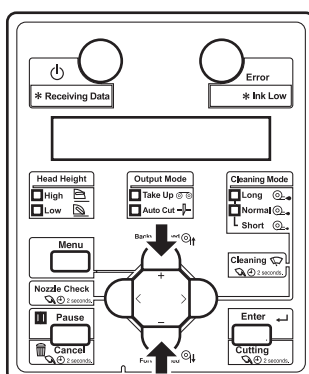

- e. Press the [Enter] key on the operation panel.

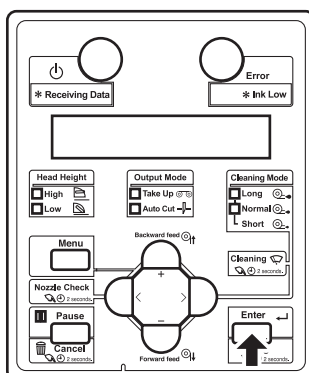

- “Please wait” is displayed on the operation panel.

- The printer scans the print using the embedded color sensor, then automatically sets up the roll media length.
 - Once successfully completed, the roll media length is displayed on the operation panel. Press the [Enter] key on the operation panel and the display shifts to Normal.
 - If failed, the message “Scan Failed ->Enter” will appear on the panel. Press the [Enter] key, and the operation panel shifts to the Roll Length menu display.

NOTE

- The printer may fail to scan if a remaining length management code has dirt or fold marks on it.
- Your printer is unable to scan if "Output Mode" is set to "Take-Up".
[☞ 5.1.6 Output Mode menu](#)
- In case the printer failed to scan the code, manually specify the Roll Length settings based on the remaining length management information printed in text on the media.
[☞ 5.9.4 Roll Length menu](#)

5.9.4 Roll Length menu

Sets up the roll media length.

Setup item	Setting	Description
Roll media	<Off>	Roll Length is not used. <ul style="list-style-type: none"> • [Enter] key: saves the setting and shifts to the previous menu. ☞ 5.9 Roll Length Manage menu
	Roll1	Sets up the roll media length. The set values of the roll media length can be set as "Roll1" to "Roll3". <ul style="list-style-type: none"> • [Enter] key: saves the setting and shifts to the sub menu. ☞ 5.9.4.1 Roll Length menu
	Roll2	
	Roll3	
	—	<ul style="list-style-type: none"> • [Cancel] key: cancels the setting and shifts to the previous menu. ☞ 5.9 Roll Length Manage menu

5.9.4.1 Roll Length menu

Sets up the roll media length.

NOTE

- After replacing the roll media, set the roll media length again.
If the roll media length is not set, the residual quantity of roll media may not be displayed correctly.

Setup item	Setting	Description
Length	1 m to <30 m> to 200 m	Sets the roll media length.
	—	<ul style="list-style-type: none"> • [Enter] key: saves the setting and shifts to the sub menu. ➤ 5.9.4.2 Print Stop menu • [Cancel] key: cancels the setting and shifts to the previous menu. ➤ 5.9.4.1 Roll Length menu

5.9.4.2 Print Stop menu

You can set whether or not to display “Roll Remain Error” and pause printing when the length of the roll media that is counted inside the printer becomes 0.

NOTE

- Normally you can set this as “Off” as the rear sensor detects when the roll paper is finished.
- If you are using the roll media that does not come off the paper core easily when it is finished, printing may not be paused when the roll media is finished, if the print pause menu is set to “Off”. If this happens, set this to “On”.
- When “Roll Remain Error” or “Roll Near End” has occurred while the Print Pause menu is set to “On”, if you pull the media loading lever towards the front after replacing to the new roll media, the Roll Media Length Setting menu is displayed. Enter the length of the roll media you have set.

Setup item	Setting	Description
Print Stop	<Off>	The roll media remaining count is not used to judge for pausing printing. Printing pauses when the rear sensor responds. <ul style="list-style-type: none"> • [Enter] key: saves the setting and shifts to the sub menu. ☞ 5.9.4 Roll Length menu
	On	Even when the rear sensor does not respond, printing pauses when the roll media remaining count becomes 0. <ul style="list-style-type: none"> • [Enter] key: saves the setting and shifts to the sub menu. ☞ 5.9.4.3 Near End menu
	—	<ul style="list-style-type: none"> • [Cancel] key: cancels the setting and shifts to the previous menu. ☞ 5.9.4 Roll Length menu

5.9.4.3 Near End menu

You can display “Roll Near End: *m” (* is replaced with a number between 1 and 10) before the length of the roll media that is counted inside the printer becomes 0.

Setup item	Setting	Description
Near end	<Off>	“Near end” is not displayed.
	Remain: 10 m to 1 m	“Near end” is displayed when the remaining count for the roll media becomes the length you selected.
	—	<ul style="list-style-type: none"> [Enter] key: saves the setting and shifts to the previous menu. ☞ 5.9.4 Roll Length menu [Cancel] key: cancels the setting and shifts to the previous menu. ☞ 5.9.4.2 Print Stop menu

5.9.5 Auto Scan menu

The ON setting will automatically scan the remaining length management code when

- the printer is powered on.
- you replace a roll media.



Setup item	Setting	Description
Auto Scan	<Off>	Auto Scan is not performed.
	On	Auto Scan is performed.
	—	<ul style="list-style-type: none"> [Enter] key: saves the setting and shifts to the previous menu. ☞ 5.9 Roll Length Manage menu [Cancel] key: cancels the setting and shifts to the previous menu. ☞ 5.9 Roll Length Manage menu

NOTE

- The printer may fail to scan if a remaining length management code has dirt or fold marks on it.
- Your printer is unable to scan if "Output Mode" is set to "Take-Up".
[☞ 5.1.6 Output Mode menu](#)
- In case the printer failed to scan the code, manually specify the Roll Length settings based on the remaining length management information printed in text on the media.
[☞ 5.9.4 Roll Length menu](#)

5.9.6 Auto Print menu

The ON setting will prompt the confirmation message when you perform media cutting, asking you whether to print a remaining length management information on a roll media. This option helps you to shorten the steps to print a remaining length management code.

Setup item	Setting	Description
Auto Print	<Off>	This confirmation message will not be displayed when you perform media cutting. The default is set to off.
	On	<p>The confirmation message "Print Roll's Remain?" appears when you perform media cutting. Use [+] key or [-] key to choose "Yes" or "No". Press [Enter] key.</p> <ul style="list-style-type: none"> When "Yes" is selected The printer prints a remaining length management code on a roll media after media is cut. When "No" is selected This code will not be printed on a roll media after media is cut.
	—	<ul style="list-style-type: none"> [Enter] key: saves the setting and shifts to the previous menu.  5.9 Roll Length Manage menu [Cancel] key: cancels the setting and shifts to the previous menu.  5.9 Roll Length Manage menu

NOTE

- The Auto Print function cannot be enabled if "Roll Length menu" is set to off.
 [5.9.4 Roll Length menu](#)

6 Maintenance

This chapter describes daily maintenance of the product.

6.1 Replacing consumable components

This section describes the replacement time and steps of ink cartridge (or ink bags), roll media, razor blade.

6.1.1 Replacing ink

This section describes when to replace the ink.

(1) Replacement time

- a. When “[****] Ink Low” is displayed on the operation panel
 - This message is displayed when there is a small amount of ink remaining.
 - The alarm buzzer sounds.
To stop the buzzer, press the [Enter] key on the operation panel.
 - Replace with a new ink.
- b. When “[****] Ink End” is displayed on the operation panel
 - This message is displayed when there is no ink remaining.
 - The alarm buzzer sounds.
To stop the buzzer, press the [Enter] key on the operation panel.
 - Immediately replace it with a new ink.

NOTE

- [****] in the above messages identify the ink color that needs to be replaced using the following characters.
 - K: Black
 - C: Cyan
 - M: Magenta
 - Y: Yellow
- Do not insert or remove ink cartridge (or high-capacity ink pack adapter) except at the time of replacement.
Inserting or removing the ink cartridge (or high-capacity ink pack adapter) mixes air into the ink tube, and failures such as nozzle clogging trouble may occur.
- If “Ink End” is displayed, the printing operation stops.
- If “Ink End” is displayed, you cannot print until inserting the new ink cartridge.
- In case you do not have a replacement at hand, leave the empty ink cartridge inserted in the printer.
Leaving the printer with the ink removed may cause the print head to clog.

(2) Type

Our genuine ink that are compatible with the printer are as follows.

Description	Model No.
Ink cartridge K (Black: 220 ml)	DH21-BK220U
Ink cartridge C (Cyan: 220 ml)	DH21-CY220U
Ink cartridge M (Magenta: 220 ml)	DH21-MA220U
Ink cartridge Y (Yellow: 220 ml)	DH21-YE220U
Ink bag K (Black: 1,000ml)	DH21-BK1000U
Ink bag C (Cyan: 1,000ml)	DH21-CY1000U
Ink bag M (Magenta: 1,000ml)	DH21-MA1000U
Ink bag Y (Yellow: 1,000ml)	DH21-YE1000U

NOTE

- To use 1000ml ink bags, high capacity pack adapters (option) are required. For details on high capacity pack adapters, contact your local MUTOH dealer.
- Use genuine ink for replacement.
This printer is designed to use genuine ink.
If you use an ink that is not a product of the original manufacturer,
Printing might become blurred, or the end of the ink in the bag might not be detected correctly.
- Any problems caused by using an ink bag other than those recommended above will not be covered by the warranty, and repair expenses will be paid by the customer.

(3) Replacing steps

Follow the procedure below to replace the ink cartridges and high capacity pack adapter.

CAUTION

- **Before operation, make sure to read the Safety Data Sheet (SDS).**
- **Wear protective equipment (gloves, goggles or eye protection, protective mask, protective clothing) when handling ink.**
Avoid contact with skin or eyes.
 - **If in eyes or on skin, wash with water immediately.**
 - **Otherwise slight irritation or bloodshot eyes may occur. If irritation is present, seek medical advice/ attention immediately.**
- **Do not disassemble ink cartridges or ink bags.**
If disassembled, ink may come into contact with eyes or skin.

NOTE

- Do not share the ink cartridge once installed with another printer. The cartridge will not be usable from that time onward.
- Do not give ink cartridges or ink bags strong shakes.
Doing so may cause ink leakage.
- Do not disassemble ink cartridges.
A disassembled ink cartridge or ink bags cannot be used.
- When an ink cartridge or ink bag is moved from a cold place to warm place, keep the ink cartridge for 3 hours or more in the new printing environment before printing.
- Do not refill an ink cartridge or ink bag with ink.
It may result in abnormal printing.
- Insert or remove the ink cartridge and high capacity pack adapter at the time of replacement only.
Inserting or removing the ink cartridge and high capacity pack adapter except at the time of replacement may result in incorrect printing.
- Be sure to use the ink before it expires.
The expired ink should be disposed of as industrial waste. The empty ink bag should be put in a plastic bag and should be disposed of according to the local regulations.

a. Replacing 220ml ink cartridges

1. Confirm that the printer is turned ON.

NOTE

- Do not replace ink cartridges when the printer is turned OFF. The remaining ink may not be detected correctly, causing abnormal printing.

2. Remove the ink cartridge that you want to replace from the slot.

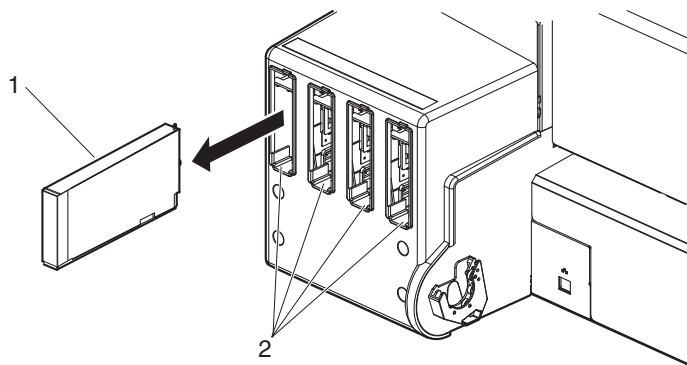

No.	Name
1	Ink cartridge
2	Ink cartridge slots

3. Take out the new ink cartridge from the package.

NOTE

- Open the bag just before attaching the ink cartridge to the ink cartridge slot. Leaving the ink cartridge with the bag open for a long time may result in abnormal printing.
- Do not insert or remove the ink cartridge more than 10 times. If the ink cartridge has been removed/inserted more than 10 times, it cannot be used even though ink remains.

4. Agitate the ink cartridges.

- Hold the ink cartridge facing the ink plug up and wait for 3 seconds.
- Next invert the cartridge and wait for 3 seconds.
- Repeat that 3 times.

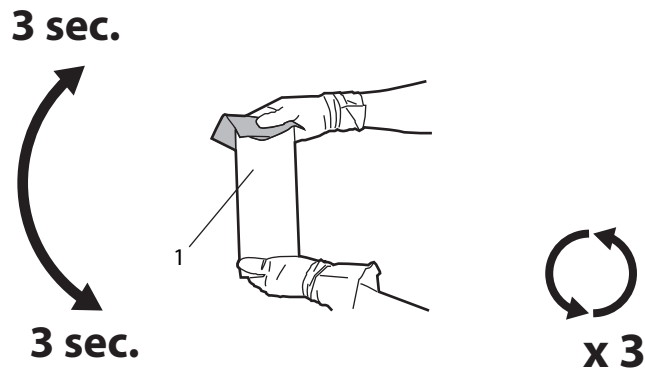

No.	Name
1	Ink cartridge

5. Install a new ink cartridge.

6. Confirm that the operation panel returns to Normal.

NOTE

- If the ink cartridge is replaced during printing, printing resumes.

- Ink cartridge replacement is complete.

b. Replacing high capacity pack adapter (option)

1. Confirm that the printer is turned ON.

NOTE

- Do not replace high capacity pack adapter when the printer is turned OFF. The remaining ink may not be detected correctly, causing abnormal printing.

2. Remove the high capacity pack adapter that you want to replace from the slot.

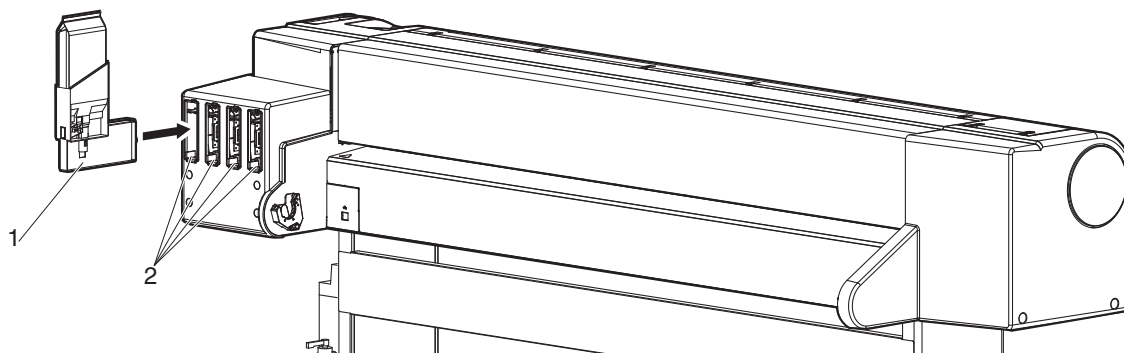

No.	Name
1	High capacity pack adapter
2	Ink cartridge slot

NOTE

- Do not remove only ink bag while high capacity pack adapter is installed on the printer. The information of the remaining smart chip card will be rewritten and the ink bag will not be usable.

3. Take out the new ink bag from the package.

NOTE

- Open the bag just before attaching the ink bag to the high capacity pack adapter. Leaving the ink bag with the bag open for a long time may result in abnormal printing.

4. Install the ink bag and a smart chip card to the high capacity pack adapter.

NOTE

- To install or remove the high capacity pack adapter to/from the ink bag and smart chip card, refer to the operation manual included with high capacity pack adapter.

5. Agitate the ink bag.

- To avoid removing the ink bag from the high-capacity pack adapter, use one hand to hold the top of the ink bag. Rotate the plug of the ink bag vertically and hold for 3 seconds.
- Then, invert the ink bag with the adapter and hold for 3 seconds.
- Repeat that 3 times.

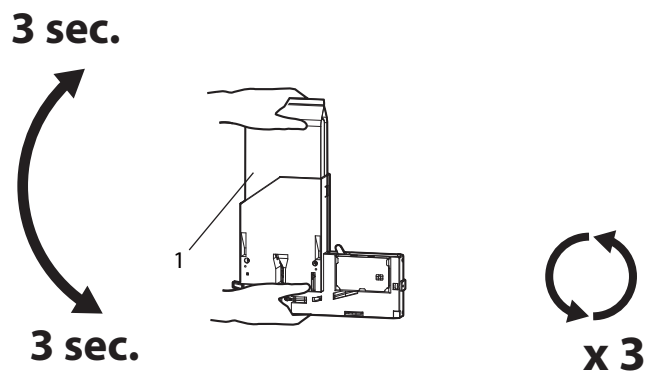

No.	Name
1	Ink bag

6. Insert the High capacity ink pack adapters into Ink cartridge slots.

NOTE

- Make sure that the ink bag and smart chip are installed on the high capacity pack adapter before inserting it to the slot. If the high capacity pack adapter is inserted into the slot without the ink bag, the remaining information will be rewritten and the ink bag will not be usable.

- Insert the high capacity pack adapter all the way to the end of the slot.

7. Confirm that the operation panel returns to Normal.

NOTE

- If the high capacity pack adapter is replaced during a print job, the printer resumes printing.

- Replacing the high capacity pack adapter is complete.

6.1.2 Replacing Roll Media

This section describes when and how to replace the roll media.

(1) Replacement time

Replace the roll media when the following situation occurs.

- a. When the roll media loaded in the printer runs out
 - “End Of Roll” is displayed on the operation panel.
 - If media runs out during printing, the printer stops printing.
- b. When you want to change the media type to use

(2) Type

TIP

- For types and details of the roll media, refer to “[8.3 Options/Supply list](#)”.

(3) Replacing steps

Follow the procedure below to replace the roll media.

1. If the printer is turned ON, confirm that operation such as printing is not in progress.
2. Push the media loading lever towards the back.

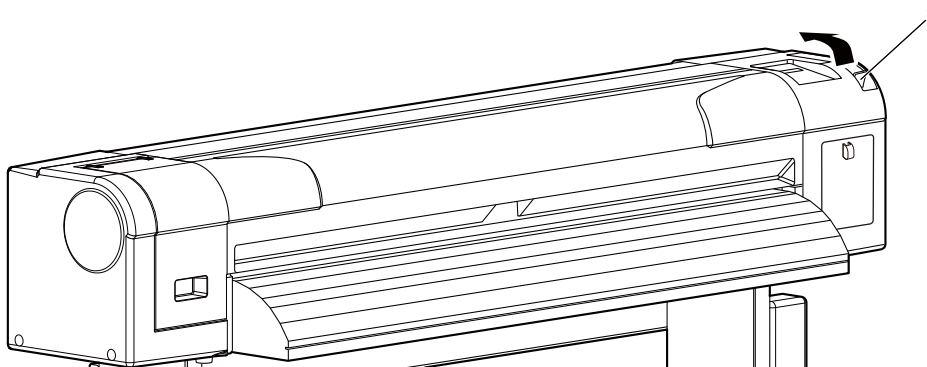

No.	Name
1	Media loading lever

3. Hold the both edges of the scroller to rewind the roll media by hands.

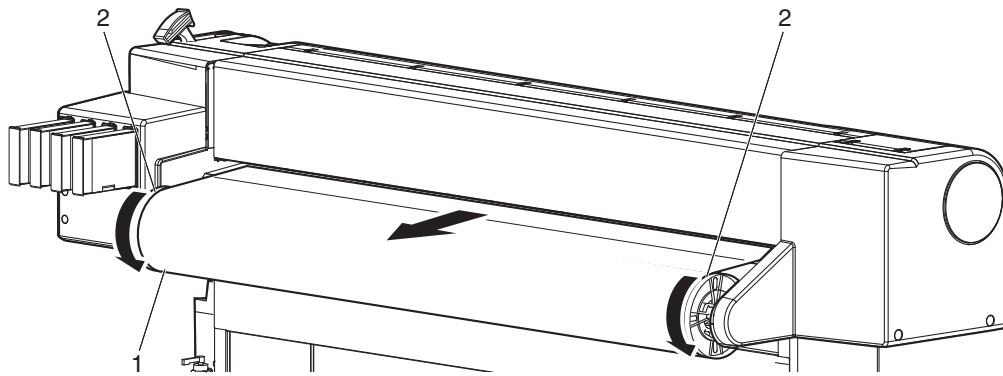

No.	Name
1	Roll media
2	Scroller

4. Remove the scroller unit, and place it on a flat floor.

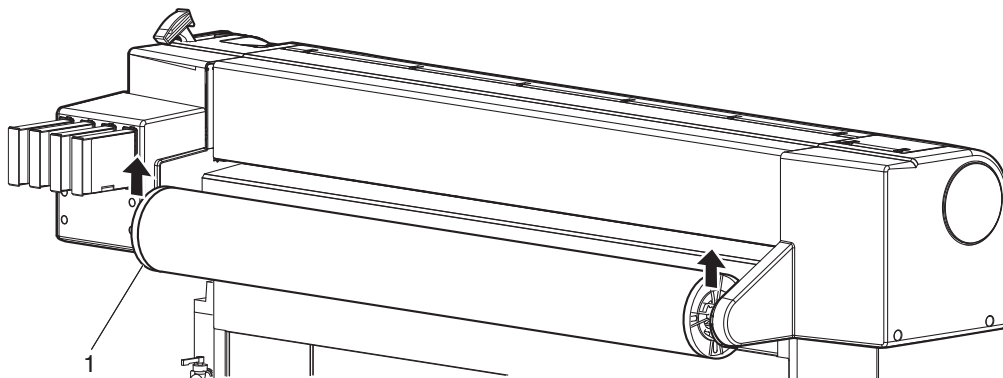

No.	Name
1	Scroller

5. Hold the movable media stopper and lightly tap it as illustrated to remove the movable media stopper.

NOTE

- When removing the roll media, do not strike the left edge of the scroller (on the movable media stopper side) strongly on the floor. The left edge of the scroller may be damaged by the impact.

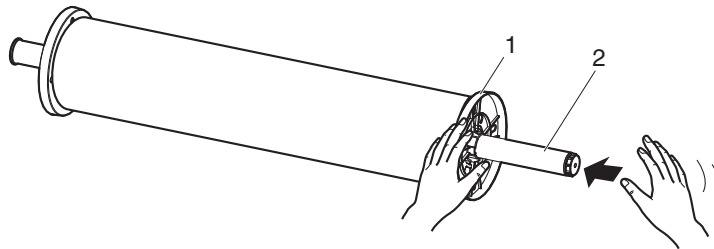

No.	Name
1	Movable media stopper
2	Scroller

6. Remove the roll media from the scroller.

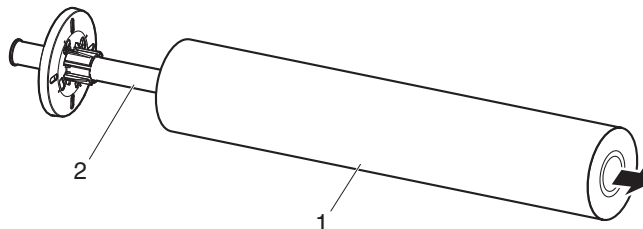

No.	Name
1	Roll media
2	Scroller

7. To load another roll media, refer to the following.

TIP

- For loading the roll media, refer to “[3.4 Loading media](#)”.
- For storing the roll media not in use, refer to “[4.2.3 Precaution on storing media after use](#)”.

8. When not loading the roll media, install the movable stopper to the scroller and set the scroller to the printer.

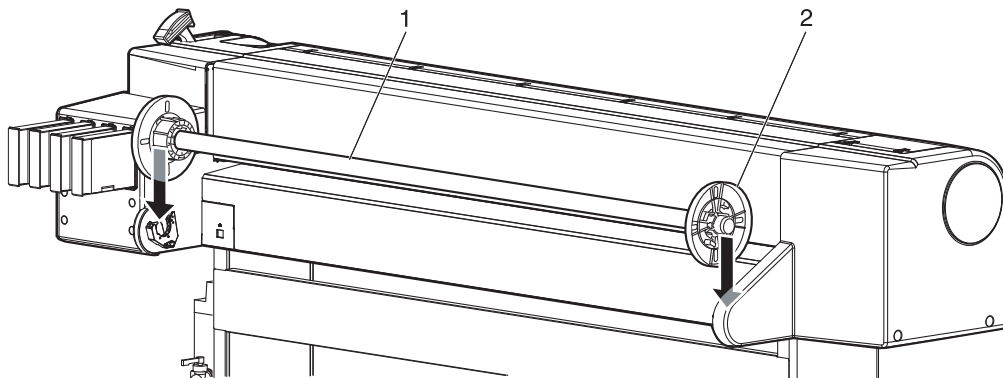

No.	Name
1	Movable media stopper
2	Scroller

6.1.3 Replacing Cutter

This section describes when and how to replace the cutter.

(1) Replacement time

Replace the cutter when the following situation occurs.

- a. When the paper is not cut smoothly
- b. When the cut surface is feathered, etc

(2) Type

Our genuine cutter that is compatible with the printer is as follows.

Description	Model No.
Cutter replacement blade	VJ-CB

(3) Replacing steps

Follow the procedure below to replace the cutter.

1. If the printer is turned ON, make sure the following.
 - Printing or other operations are not in progress.
 - "Ready to Print" is displayed on the operation panel.
2. Go to the CR Maintenance menu on the operation panel.
 - a. Press the [Menu] key on the operation panel.

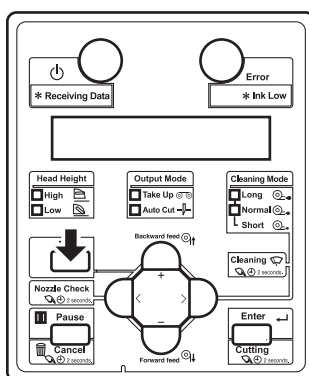

- "Menu 1: Setup>" is displayed on the operation panel.
- The operation panel shifts to the Setup menu display.

- b. Press the [>] key on the operation panel.

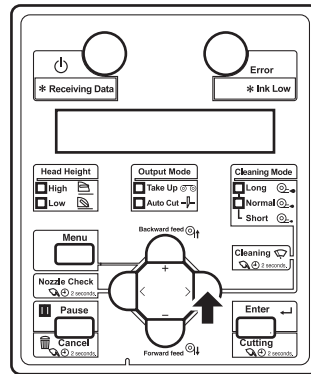

- “Set1: User Type” is displayed on the operation panel.
- c. Press the [+] key or [-] key to select “Set17: CR Maintenance”.

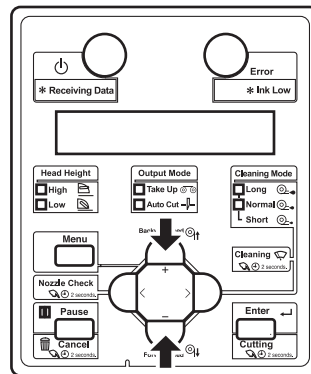

- d. Press the [Enter] key on the operation panel.

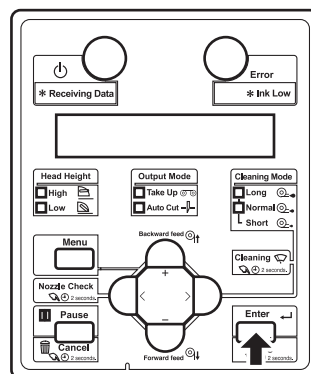

- “CR Maint.: Start” is displayed on the operation panel.
 - The display enters the CR Maintenance menu.
-  [5.1.15 CR Maintenance menu](#)

3. Press the [Enter] key on the operation panel.

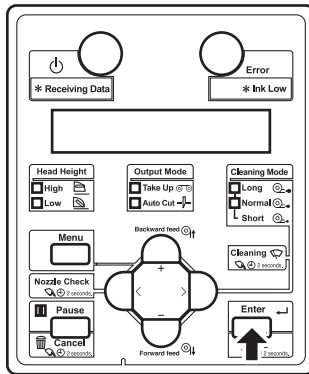

- Maintenance starts.
- The print head moves to the left of the printer (cutter replacement position).
- “CR Maintenance: End” is displayed on the operation panel.

4. Open Maintenance cover L.

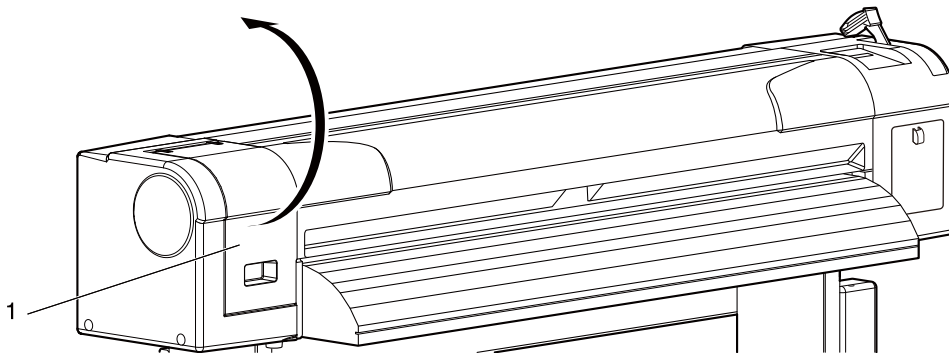

No.	Name
1	Maintenance cover L

NOTE

- Replace the cutter in a short time.
Leaving the print head at the cutter replacement position may result in clogging of the print head.

5. Press the tab of the cutter lightly, turn the cutter holder in the direction as illustrated below.

NOTE

- Do not press the tab of the cutter strongly or suddenly let go of it.
There is a spring in the cutter holder and it may fly out.
- Do not push the cutter all the way in.
The cutter blade may damage the inside of the printer.

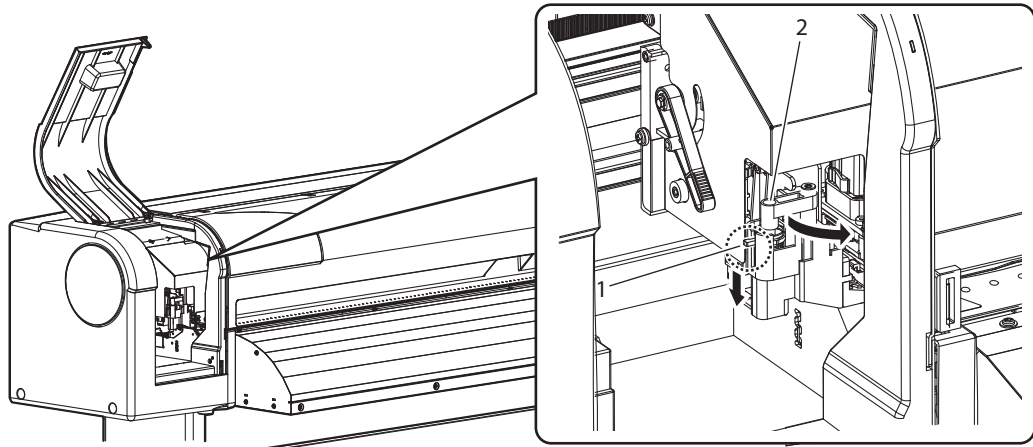

No.	Name
1	Cutter holder
2	Cutter holder lever

6. Remove the cutter.

CAUTION

- Do not touch the blade edge.
It may cause an injury.
- Do not touch the cutter blade edge with a hard substance or drop the cutter.
The cutter blade may be damaged or chipped.

NOTE

- Used cutter should be put in a plastic bag, etc, and dispose of it in compliance with local ordinance and instructions of local authorities.

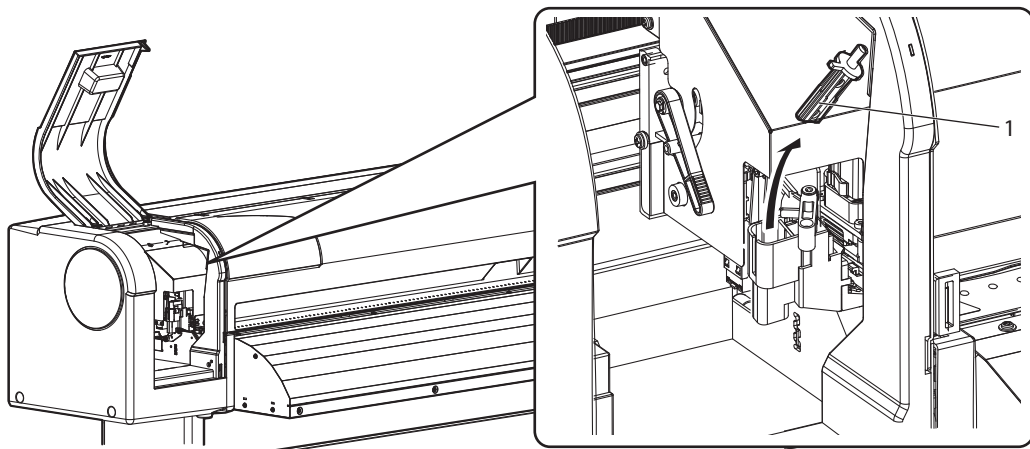

No.	Name
1	Razor blade

7. Install a new cutter as illustrated.

NOTE

- Make sure that the spring in the cutter holder does not fly out while installing.

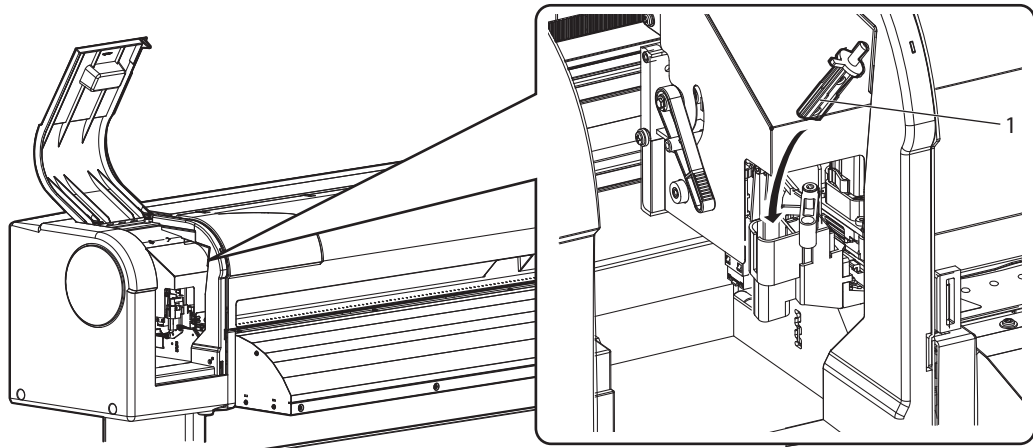

No.	Name
1	Razor blade

8. Press the tab of the cutter lightly, return the cutter holder to its initial position.

NOTE

- Do not press the tab of the cutter strongly or suddenly let go of it.
There is a spring in the cutter holder and it may fly out.
- Do not push the cutter all the way in.
The cutter blade may damage the inside of the printer.
- Refer to the illustrations below and install the cutter holder correctly.
If it is not installed correctly, it may cause an error.
If an error occurs, check if the cutter holder is installed correctly.

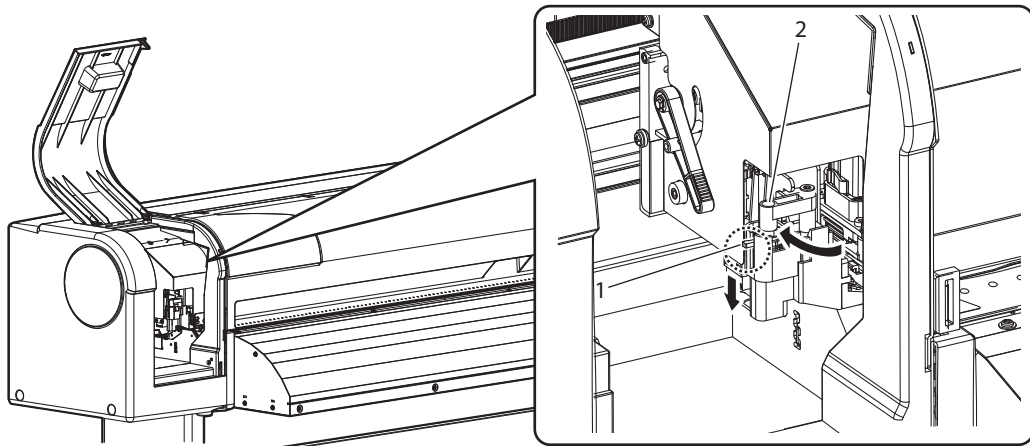

No.	Name
1	Cutter holder
2	Cutter holder lever

9. Close Maintenance cover L.

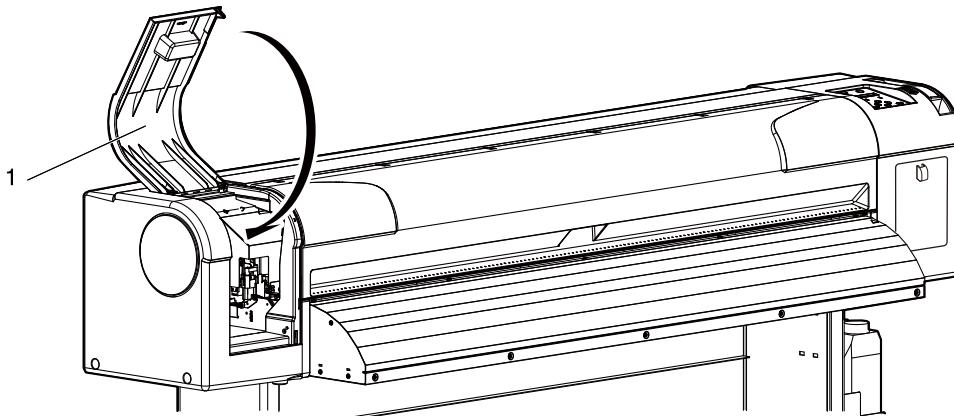

No.	Name
1	Maintenance cover L

10. Press the [Enter] key on the operation panel.

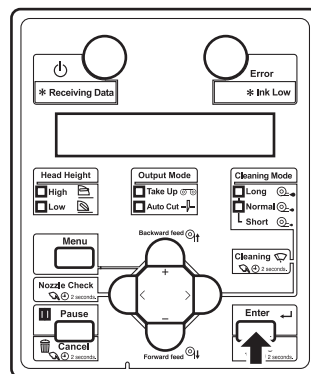

- The print head returns to its original position.
- “CR Maint.: Start” is displayed on the operation panel.

11. Press the [Menu] key on the operation panel.

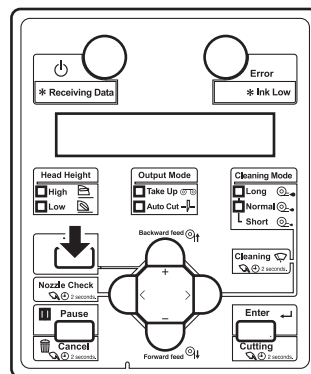

- "Ready to Print" is displayed.
- Cutter replacement is complete.

6.1.4 Replacing the cleaning wiper

This section explains how to replace the cleaning wiper.

NOTE

Make sure to install the cleaning wiper in the printer.
The cleaning wiper is an essential part to make printing consistent.

(1) Replacement time

- Every twelve months

(2) Type

TIP

For types and details of the cleaning wiper, contact your local MUTOH dealer.

(3) Replacing steps

Follow the steps below to replace the cleaning wiper.

CAUTION

- **Wear protective equipment (gloves, goggles or eye protection, protective mask, protective clothing) when handling ink. Avoid contact with skin or eyes.**
- **If in eyes or on skin, wash with water immediately.**
- **Otherwise slight irritation or bloodshot eyes may occur. If irritation is present, seek medical advice/ attention immediately.**

1. Check the followings while the printer is turned ON.

- Printing or other operations are not in progress.
- Operation panel display is Normal.

2. Go to the CR Maintenance menu on the operation panel.
 - a. Press the [Menu] key on the operation panel.

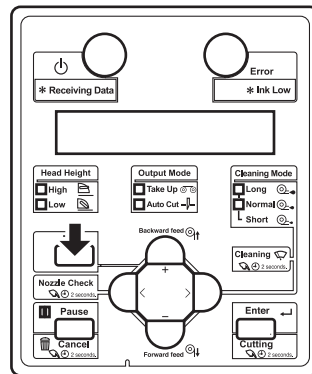

- “Menu 1: Setup>” is displayed on the operation panel.
 - The operation panel shifts to the Setup menu display.
- b. Press the [>] key on the operation panel.

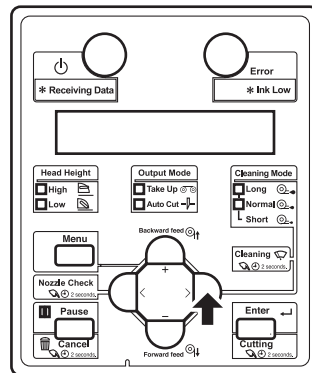

- “Set1: User Type” is displayed on the operation panel.
- c. Press the [+] key or [-] key to select “Set17: CR Maintenance”.

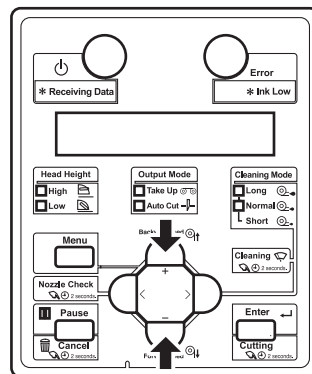

- d. Press the [Enter] key on the operation panel.

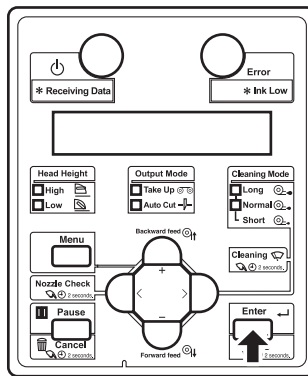

- “CR Maint.: Start” is displayed on the operation panel.
- The display enters the CR Maintenance menu.

5.1.15 CR Maintenance menu

3. Press the [Enter] key on the operation panel.

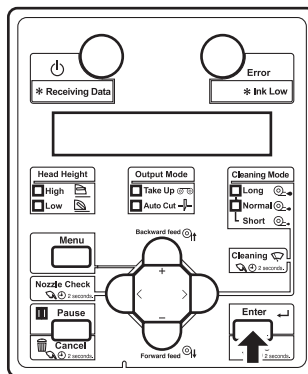

- Maintenance starts.
- The print head moves to the left of the printer (cutter replacement position).
- “CR Maintenance: End” is displayed on the operation panel.

4. Open the front cover.

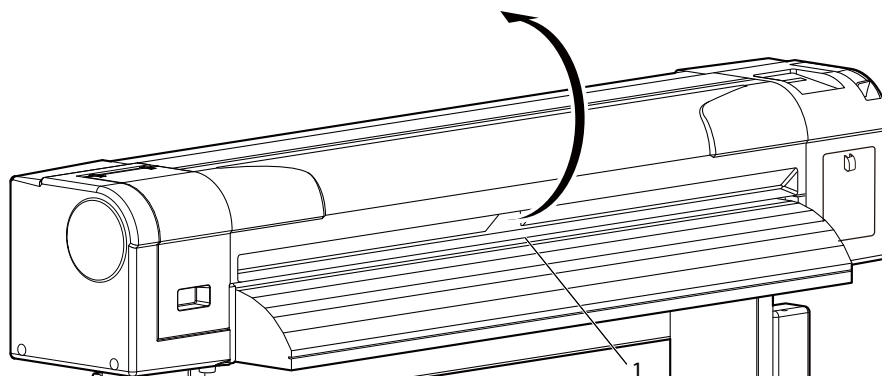

No.	Name
1	Front cover

5. Remove the maintenance cover R.

- Turn the knob to left until it clicks.
- Open the maintenance cover R while sliding the knob down.
- Remove the maintenance cover R.

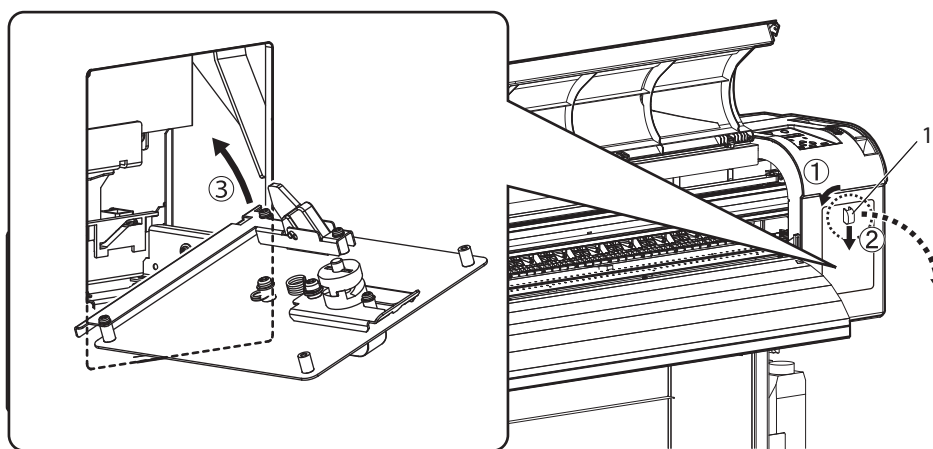

No.	Name
1	Maintenance cover R

6. Remove the cleaning wiper.

- Slide the hook on the wiper to the front side to unhook from the wiper slot.
- Lift the hook and remove the cleaning wiper.

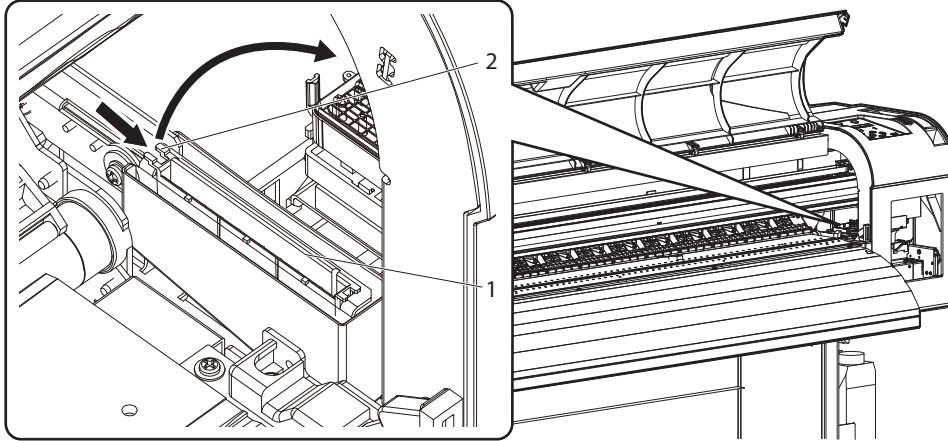

No.	Name
1	Cleaning wiper
2	Cleaning wiper hook

7. Follow the steps below to install new cleaning wiper.

- Slide the front side of the new cleaning wiper into its slot.
- Press the wiper hook down until it clicks into place.

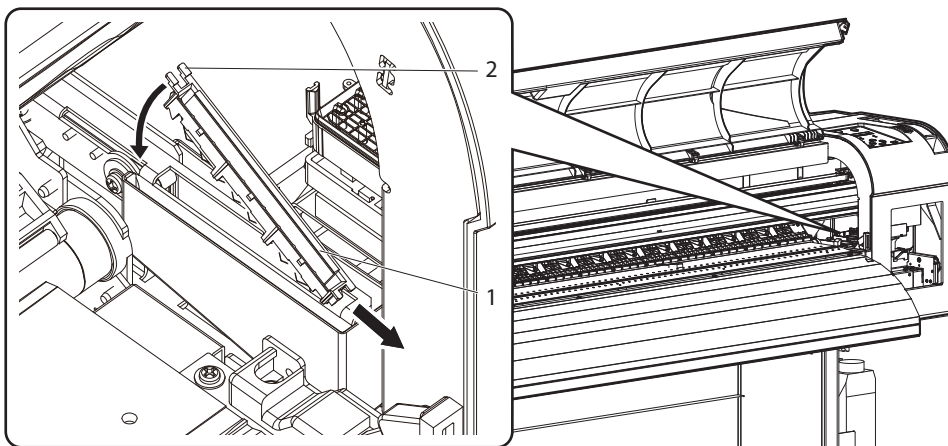

No.	Name
1	Cleaning wiper
2	Cleaning wiper hook

8. Close the maintenance cover R.

- Attach the bottom of the maintenance cover R to the printer.
- While turning the knob to left and sliding it down, close the upper side of the cover.
- Turn the knob back to the original position to lock the upper side of the cover.

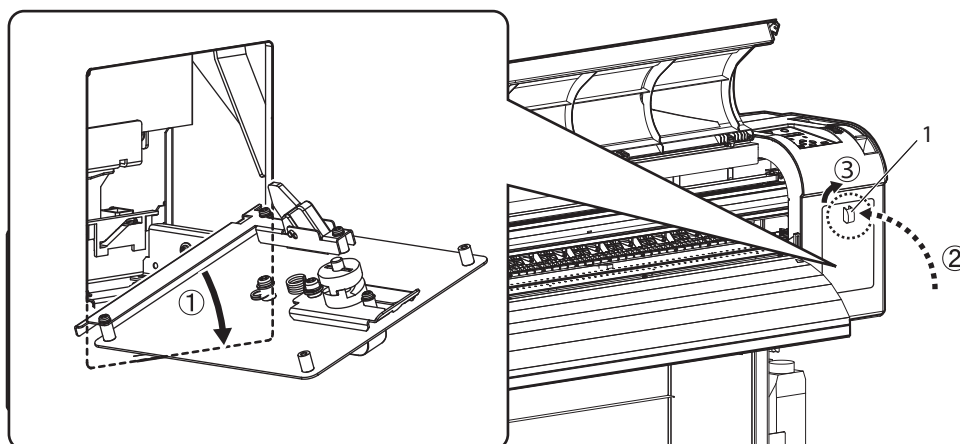

No.	Name
1	Maintenance cover R

9. Close the front cover.

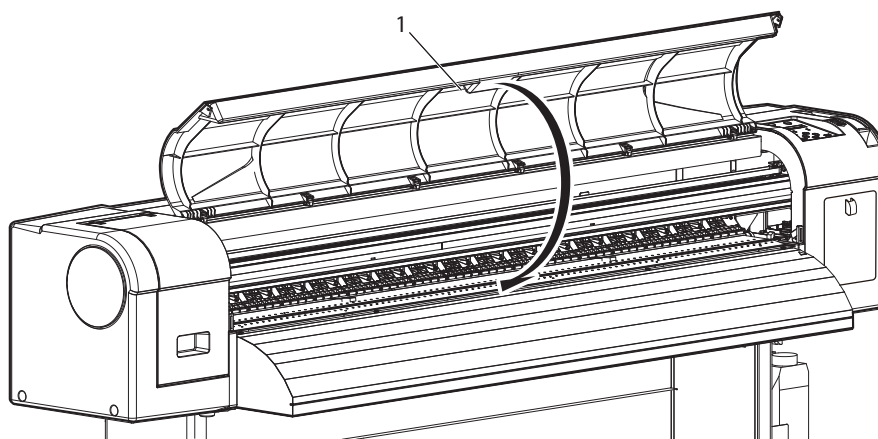

No.	Name
1	Front cover

10. Press the [Enter] key on the operation panel.

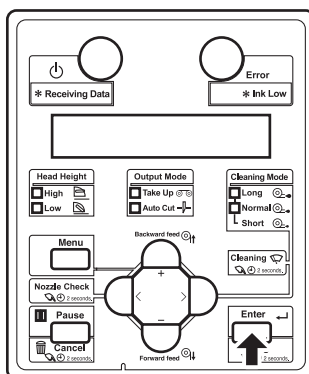

- The print head returns to its original position.
- “CR Maint.: Start” is displayed on the operation panel.

11. Press the [Menu] key on the operation panel.

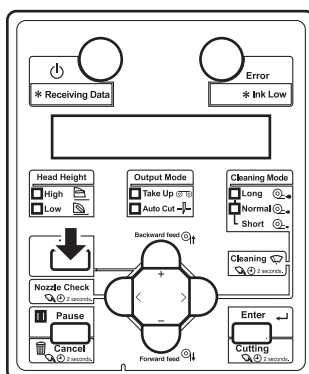

- "Ready to Print" is displayed.
- This completes the replacement procedure of the cleaning wiper.

6.2 Cleaning the printer

Periodic (every month) cleaning is necessary to use the printer in good condition.

WARNING

- **Do not insert or drop metal or flammable objects into the printer through openings such as a vent.**
It could lead to an electric shock or fire.
- **If foreign substances or liquids such as water entered the printer, do not use the printer as it is.**
It could lead to an electric shock or fire.
Immediately turn OFF the power switch, disconnect the power plug from the electric socket, and contact your local MUTOH dealer.

CAUTION

- **When cleaning the areas other than wiper or around the print head, make sure to turn OFF the power and unplug the power cord.**
- **Do not use volatile solvents such as thinner, benzene, or alcohol.**
These solvents could cause damage to the paint.
- **Be careful that no moisture enters the printer.**
This could result in an electrical short circuit.
- **Do not open covers attached using screws under any circumstances.**
This may cause an electric shock or a malfunction.

This section describes how to clean each part of the printer.

6.2.1 Cleaning the outer case

This section describes how to clean the outer case.

Wipe out dust and dirt attached to the outer case by using a soft cloth.

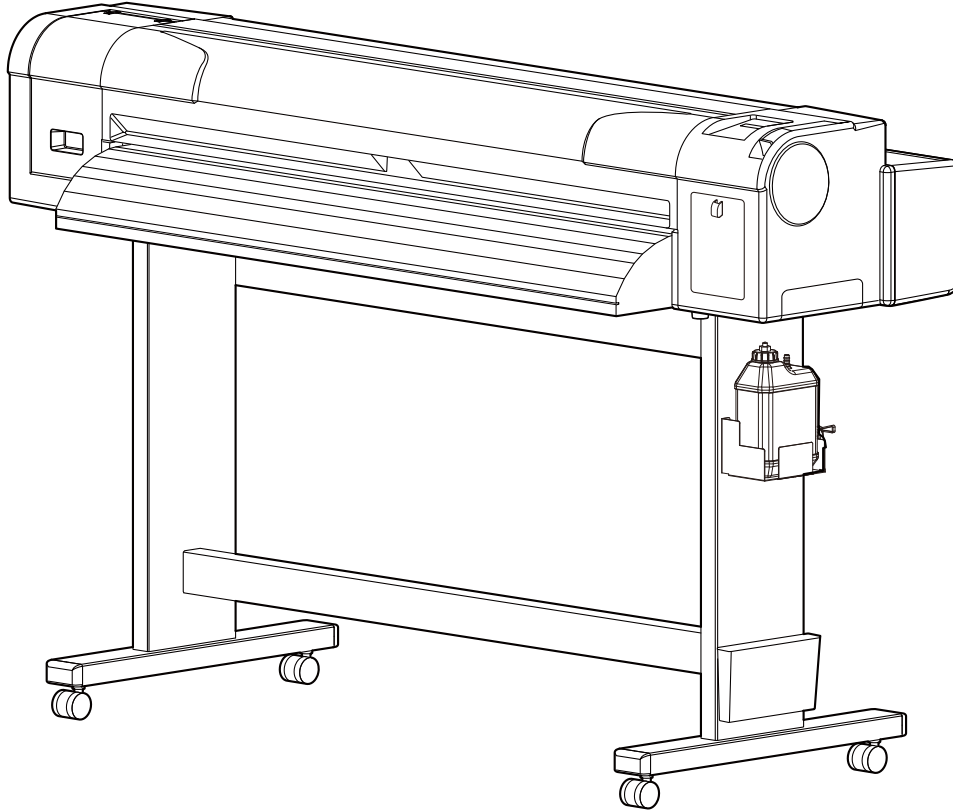

6.2.2 Cleaning the inside of the printer

This section describes how to clean the inside of the printer.

Follow the procedure below.

1. Open the front cover.

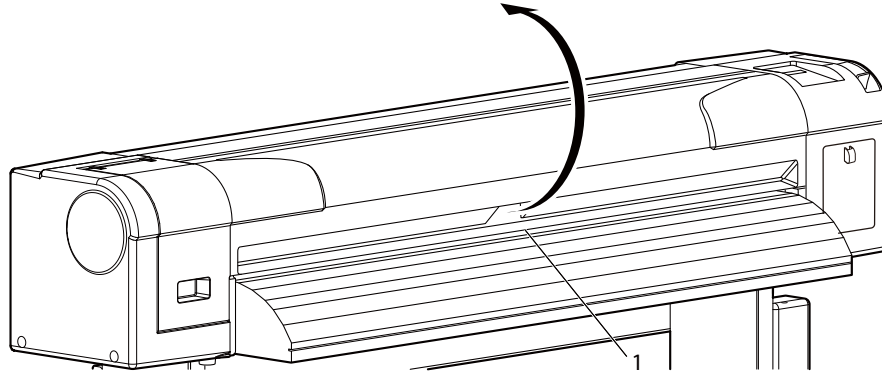

No.	Name
1	Front cover

2. Remove paper powder and dust attached to the pressurizing rollers using a soft brush.

NOTE

- Do not blow paper powder inside the printer using tools such as an air duster. It may cause an abnormal noise from the inside of the printer.

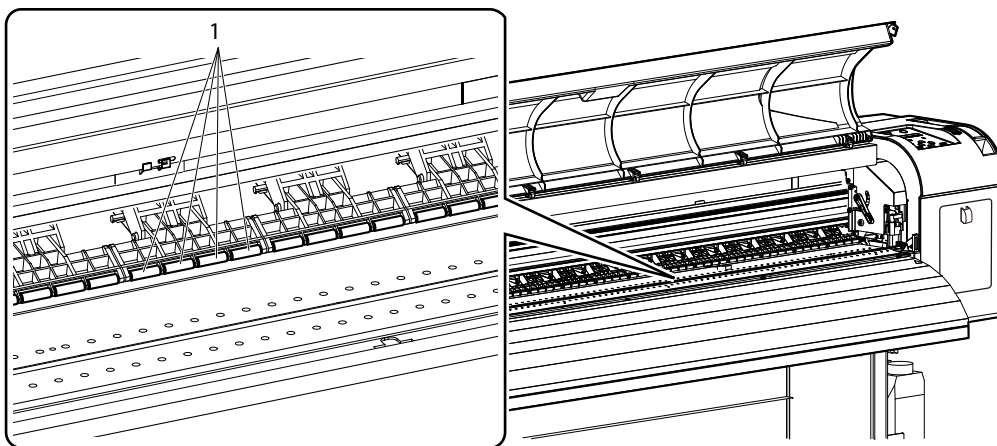

No.	Name
1	Pressurizing rollers

3. Apply a damp and tightly squeezed soft cloth to wipe out paper powder and ink attached to the platen and media guide.

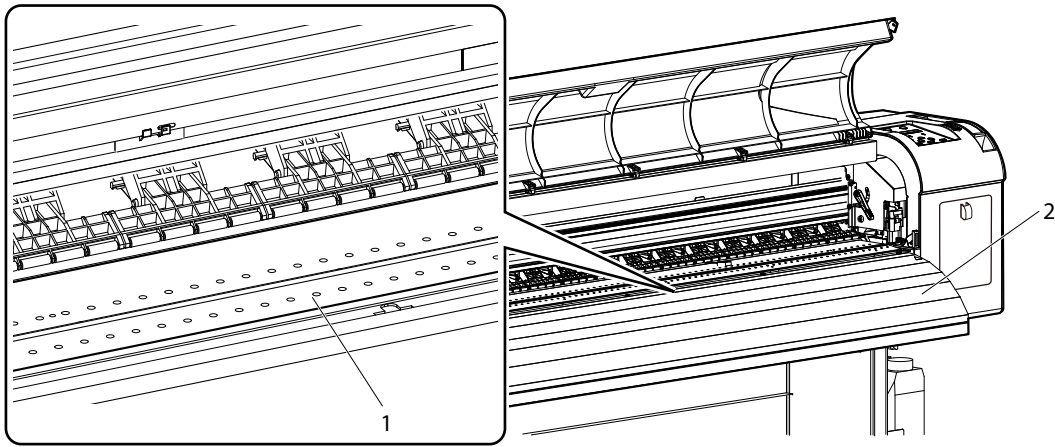

No.	Name
1	Platen
2	Media guide

4. Apply a damp and tightly squeezed soft cloth to wipe off the dirt of the unpainted (silver color) area in the center of the grid roller.

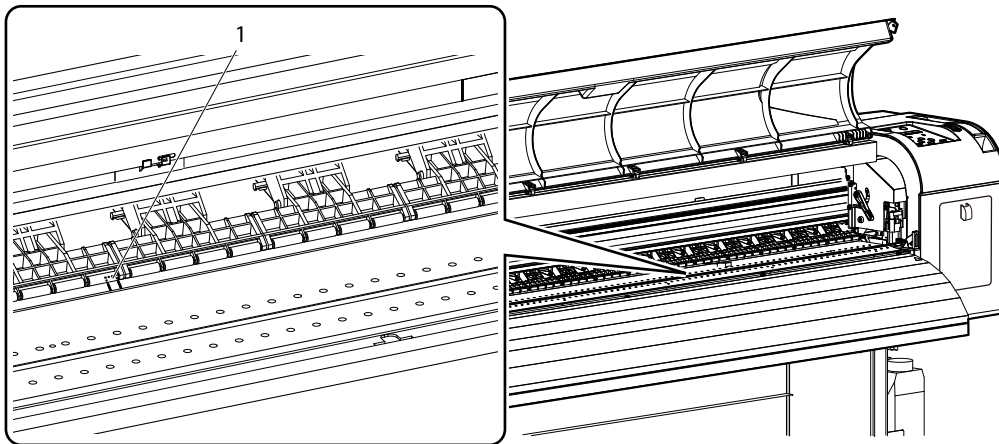

No.	Name
1	Grid roller

6.2.3 Head cleaning

If printed data is blurred or lacks part of it, clean the print head surface and nozzle (Head cleaning).

Follow the procedure below to perform Head cleaning.

NOTE

- When not using the printer for a long period (one week or more), perform Head cleaning once a week.

If not performing Head cleaning, the print head is clogged. Doing so will preserve print quality. When you may not be able to run a weekly cleaning on the printer that is in sleep mode: Perform "Longstore" and then power off the printer.

☞ [6.5.1 Long-term storage](#)

- If the humidity in the work area is below 40%, clogged nozzles may not be recovered by head cleaning. Make sure to use your printer in the recommended printing environment.

☞ [8.1.1 Printer specifications](#) > [Recommended printing condition](#)

- Check that "Ready to Print" is displayed on the operation panel.
- Make sure that the media loading lever is pulled towards the front.
- Press the [>] key on the operation panel to select the cleaning mode.

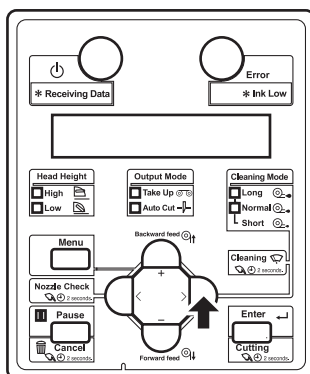

- Press the [Cleaning] key on the operation panel for at least two seconds.

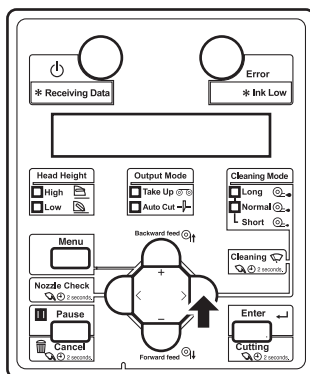

- Start Head cleaning.
- “Cleaning **%” is displayed on the operation panel.
- After Head cleaning is complete, the operation panel shifts to Normal.

NOTE

- If you fail to remove blurs or incompleteness of printing in one Head cleaning, perform strong cleaning.
 - If blurs or lacking parts in printed media do not disappear with several times of Head cleaning, refer to “[7 Troubleshooting](#)”, and take appropriate measures.
-

6.2.4 Cleaning the cleaning wiper

This section describes how to clean the cleaning wiper.

(1) When to clean

Once a week, or when blurs or lacking parts appear on printed media after Head cleaning.

(2) Cleaning procedures

Follow the procedure below to clean the cleaning wiper.

NOTE

- Use the cleaning stick to clean the cleaning wiper.
For details of the cleaning stick, refer to “[8.3 Options/Supply list](#)”.
-

1. If the printer is turned ON, make sure the following.
 - Printing or other operations are not in progress.
 - "Ready to Print" is displayed on the operation panel.

2. Go to the CR Maintenance menu on the operation panel.
 - a. Press the [Menu] key on the operation panel.

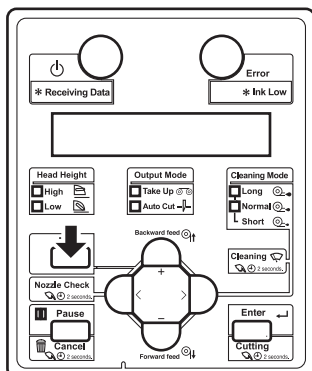

- “Menu1: Setup>” is displayed on the operation panel.
 - The operation panel shifts to the Setup menu display.
- b. Press the [>] key on the operation panel.

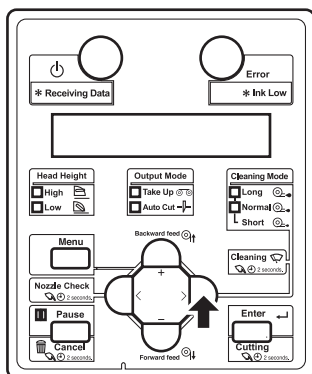

- “Set1: User Type” is displayed on the operation panel.
- c. Press the [+] key or [-] key to select “Set17: CR Maintenance”.

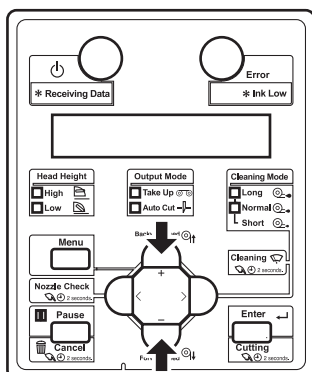

- d. Press the [Enter] key on the operation panel.

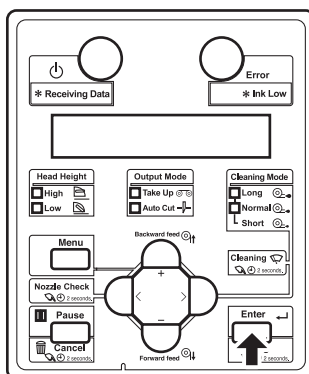

- “CR Maint.: Start” is displayed on the operation panel.
- The display enters the CR Maintenance menu.

 **5.1.15 CR Maintenance menu**

3. Press the [Enter] key on the operation panel.

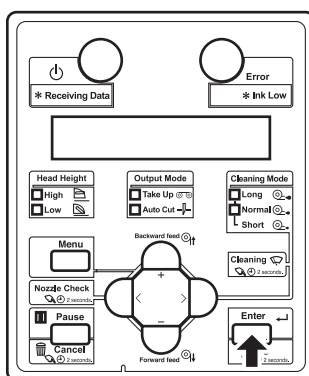

- Maintenance starts.
- The print head moves to the left.
- “CR Maint.: End” is displayed on the operation panel.

4. Open the front cover.

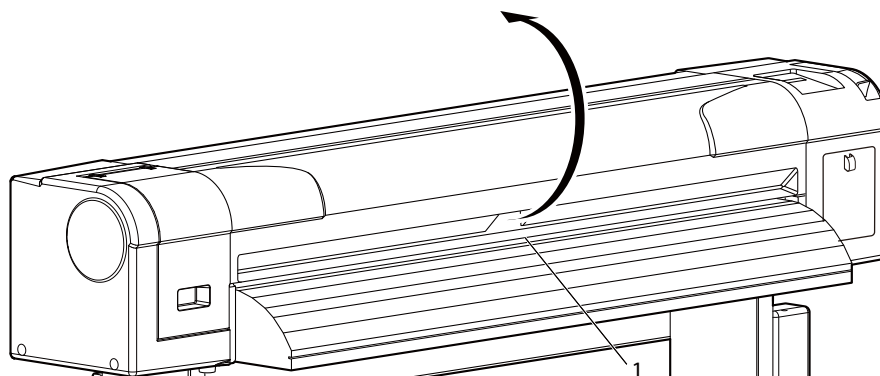

No.	Name
1	Front cover

CAUTION

- When cleaning the cleaning wiper,
 - do not touch the cleaning wiper and head cap unit.
Head cleaning may not be performed correctly because of oil from your hands.
 - Make sure to wipe the print head using the cleaning stick.
A wet cleaning stick may cause the print head to clog.
 - Do not reuse the cleaning stick.
Dust on the stick may damage the print head.

5. Use the cleaning stick to remove the ink and dust on the cleaning wiper.

a. Front side of the cleaning wiper:

Remove the ink and dust in the horizontal direction.

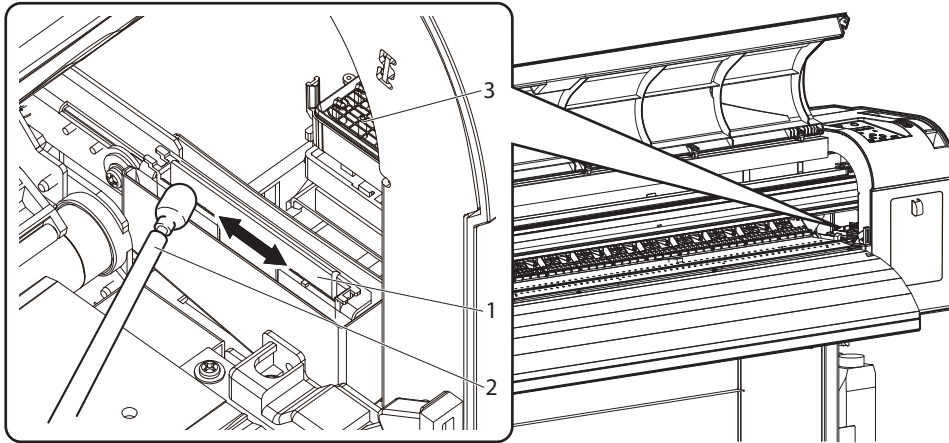

No.	Name
1	Cleaning wiper
2	Cleaning stick
3	Head cap unit

b. Cleaning wiper back side:

Remove the ink and dust in the upper direction.

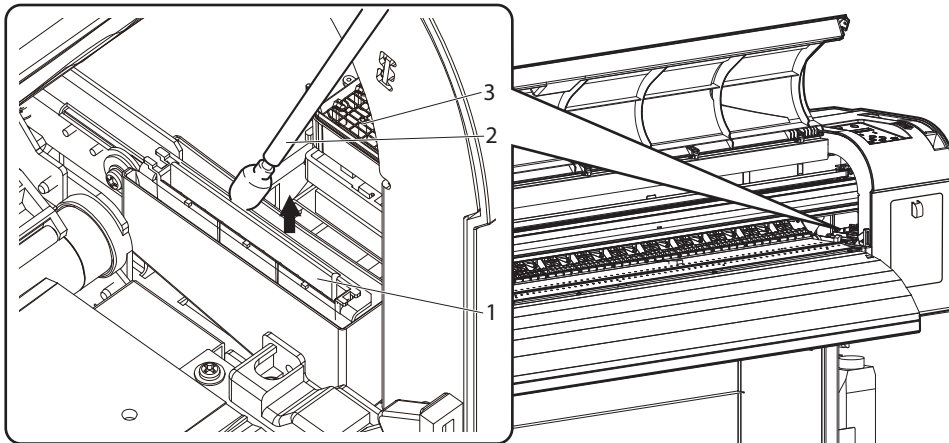

No.	Name
1	Cleaning wiper
2	Cleaning stick
3	Head cap unit

6. Close the front cover.

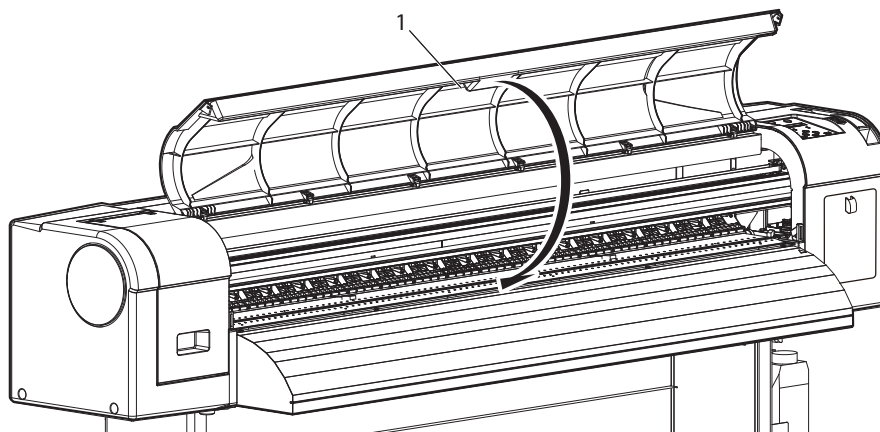

No.	Name
1	Front cover

7. Press the [Enter] key on the operation panel.

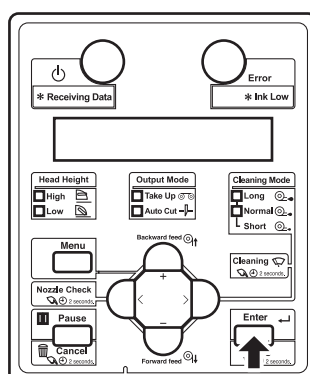

- The print head returns to its original position.
- “CR Maint.: Start” is displayed on the operation panel.

8. Press the [Menu] key on the operation panel.

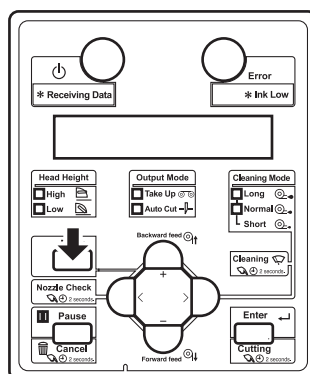

- "Ready to Print" is displayed.
- Cleaning the cleaning wiper is complete.

6.2.5 Cleaning around the capping unit

This section describes how to clean around the capping unit.

(1) When to clean

Weekly

(2) Cleaning procedures

Follow the procedure below to clean around the capping unit.

NOTE

- Before cleaning around the capping unit, read this procedure thoroughly to fully understand it, and clean promptly and correctly.
 - While cleaning around the capping unit, with the cap removed from the print head, therefore cleaning must be done before the print head dries.
This operation should be done within 15 minutes.
If the operation lasts over 15 minutes, follow the Steps 7 to 9 to stop the operation and perform head cleaning, then resume cleaning.
 [6.2.3 Head cleaning](#)
 - Use the cleaning stick to clean around the capping unit.
For details of the cleaning stick, refer to "[8.3 Options/Supply list](#)".
-

1. If the printer is turned ON, make sure the following.
 - Printing or other operations are not in progress.
 - "Ready to Print" is displayed on the operation panel.

2. Go to the CR Maintenance menu on the operation panel.
 - a. Press the [Menu] key on the operation panel.

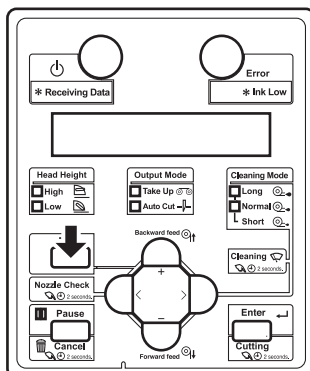

- “Menu1: Setup>” is displayed on the operation panel.
 - The operation panel shifts to the Setup menu display.
- b. Press the [>] key on the operation panel.

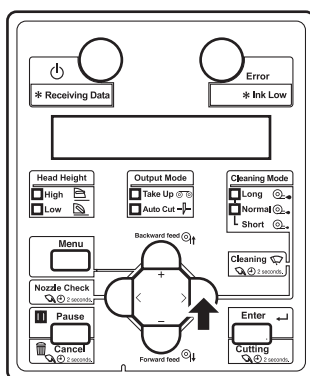

- “Set1: UserType” is displayed on the operation panel.
- c. Press the [+] key or [-] key to select “Set17: CR Maintenance”.

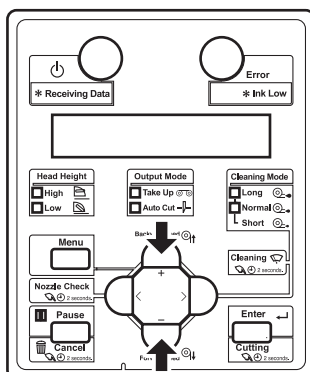

- d. Press the [Enter] key on the operation panel.

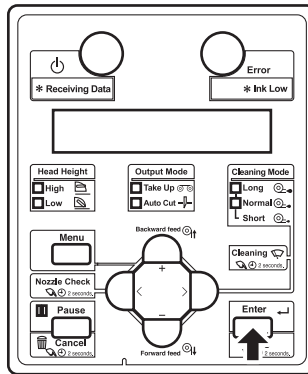

- “CR Maine.: Start” is displayed on the operation panel.
- The display enters the CR Maintenance menu.

5.1.15 CR Maintenance menu

3. Press the [Enter] key on the operation panel.

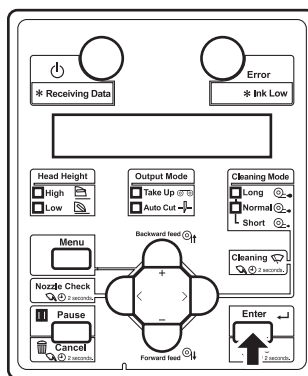

- Maintenance starts.
- The print head moves to the left.
- “CR Maintenance: End” is displayed on the operation panel.

4. Open the front cover.

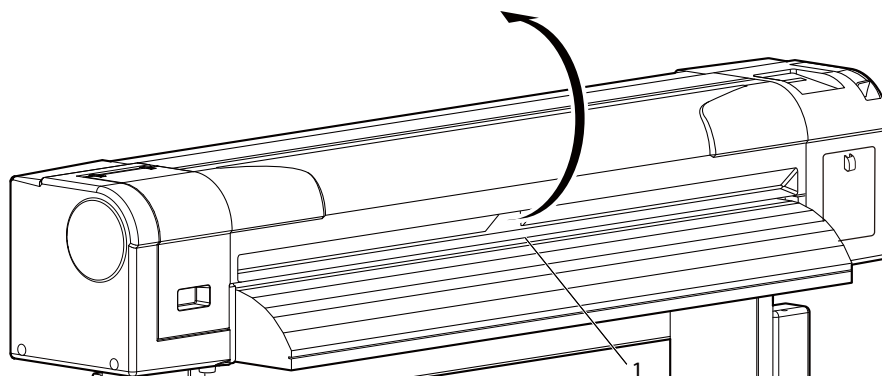

No.	Name
1	Front cover

5. Remove the maintenance cover R.

- Turn the knob to left until it clicks.
- Open the maintenance cover R while sliding the knob down.
- Remove the maintenance cover R.

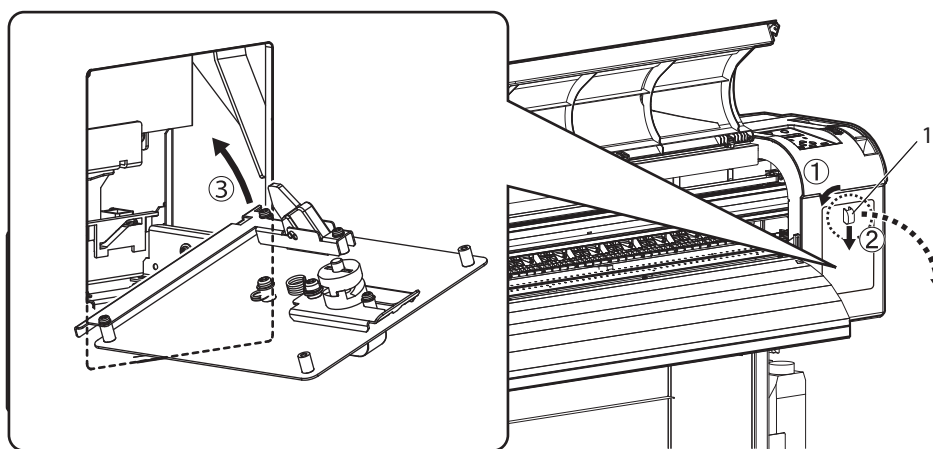

No.	Name
1	Maintenance cover R

6. Use the cleaning stick to clean around the rubber part of the capping unit to remove the ink deposits and dust.

CAUTION

- **When cleaning around the capping unit,**
 - **Use a dry cleaning stick. A damp stick can cause damage to the print head.**
 - **Do not touch the tip of a cleaning stick with fingers. Skin oil will damage the print head.**
 - **Do not reuse a cleaning stick. Dust on the stick will damage the print head.**

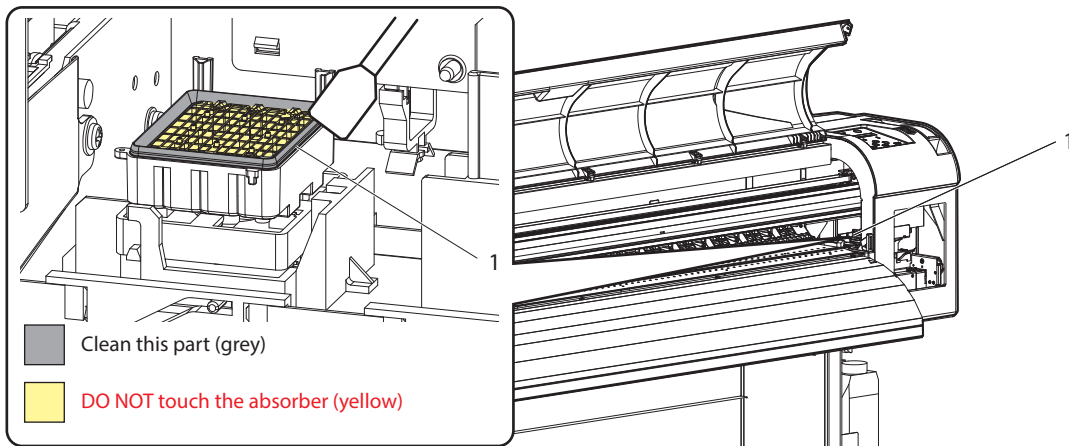

No.	Name
1	Around the capping unit

7. Close the maintenance cover R.

- Attach the bottom of the maintenance cover R to the printer.
- While turning the knob to left and sliding it down, close the upper side of the cover.
- Turn the knob back to the original position to lock the upper side of the cover.

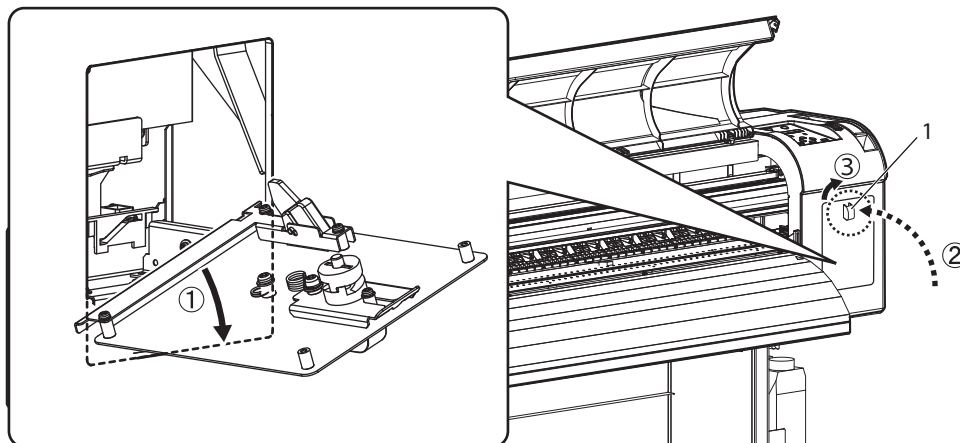

No.	Name
1	Maintenance cover R

8. Close the front cover.

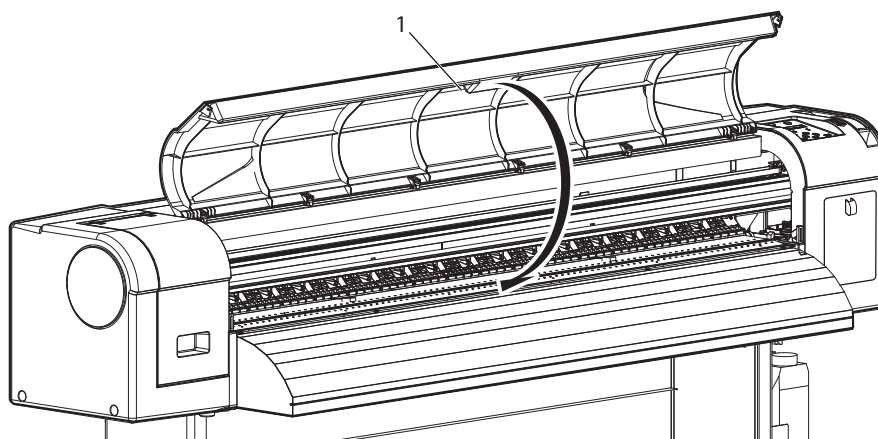

No.	Name
1	Front cover

9. Press the [Enter] key on the operation panel.

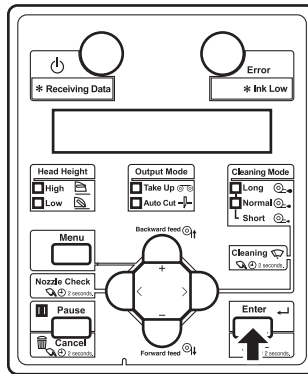

- The print head returns to its original position.
- “CR Maine.: Start” is displayed on the operation panel.

10. Press the [Menu] key on the operation panel.

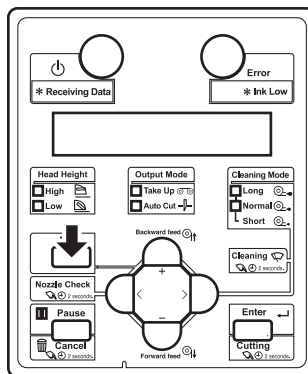

- "Ready to Print" is displayed.
- Cleaning around the print head is complete.

6.2.6 Cleaning around the print head

This section describes how to clean around the print head.

(1) When to clean

When foreign substances such as dust or ink clump that can cause missing dots or ink leakage is attached around the print head.

(2) Cleaning procedures

Follow the procedure below to clean around the print head.

NOTE

- Before cleaning around the print head, read this procedure thoroughly to fully understand it, and clean promptly and correctly.
- While cleaning around the capping unit, with the cap removed from the print head, therefore cleaning must be done before the print head dries.
This operation should be done within 15 minutes.
If the operation lasts over 15 minutes, follow the Steps 8 and 9 to stop the operation and perform head cleaning, then resume cleaning.
 [6.2.3 Head cleaning](#)
- Use the cleaning stick to clean around the print head.
For details of the cleaning stick, refer to “[8.3 Options/Supply list](#)”.

1. If the printer is turned ON, make sure the following.
 - Printing or other operations are not in progress.
 - "Ready to Print" is displayed on the operation panel.

2. Go to the CR Maintenance menu on the operation panel.
 - a. Press the [Menu] key on the operation panel.

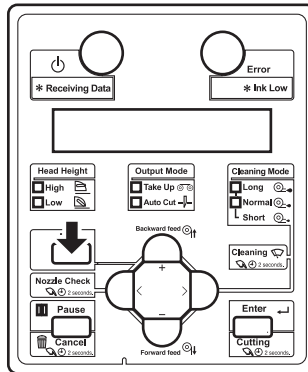

- “Menu1: Setup>” is displayed on the operation panel.
 - The operation panel shifts to the Setup menu display.
- b. Press the [>] key on the operation panel.

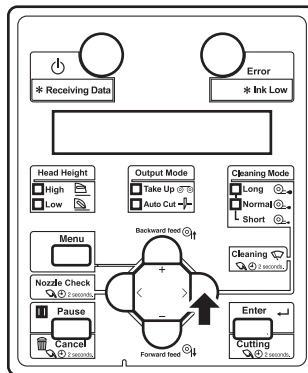

- “Set1: UserType” is displayed on the operation panel.
- c. Press the [+] key or [-] key to select “Set17: CR Maintenance”.

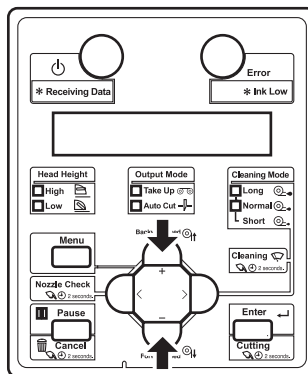

d. Press the [Enter] key on the operation panel.

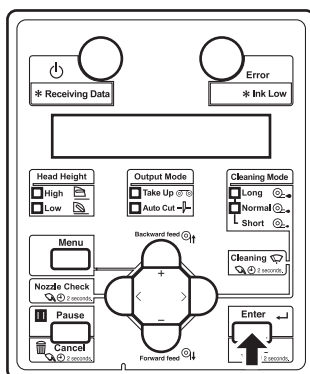

- “CR Maine.: Start” is displayed on the operation panel.
- The display enters the CR Maintenance menu.

 **5.1.15 CR Maintenance menu**

3. Press the [Enter] key on the operation panel.

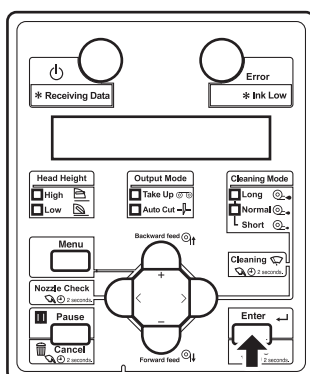

- Maintenance starts.
- The print head moves to the left.
- “CR Maintenance: End” is displayed on the operation panel.

4. Open the maintenance cover L.

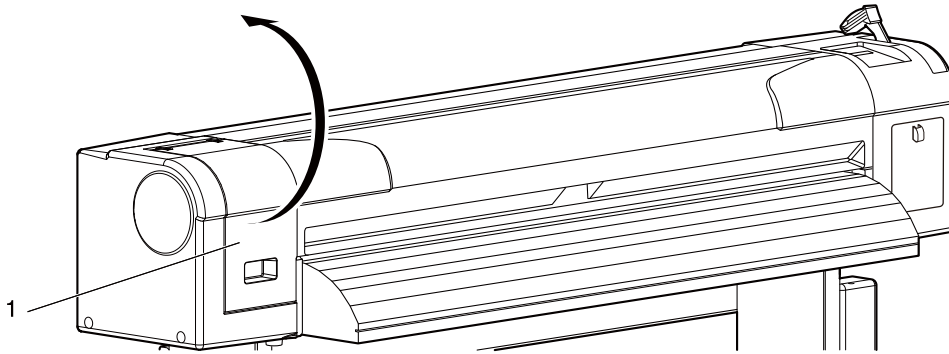

No.	Name
1	Maintenance cover L

5. Move the print head section by hand to where the circumference of the Print head is visible.

CAUTION

- Do not press the Print head section strongly. Doing so may cause damage or poor print results.

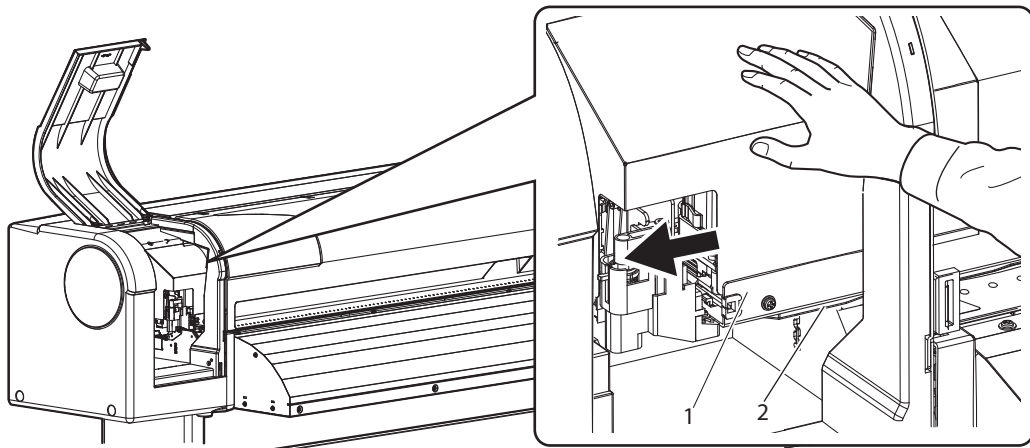

No.	Name
1	Print head section
2	Circumference of the Print head

6. Use a penlight, etc to check if any foreign substance, such as dust or ink clump, is attached to the following places.

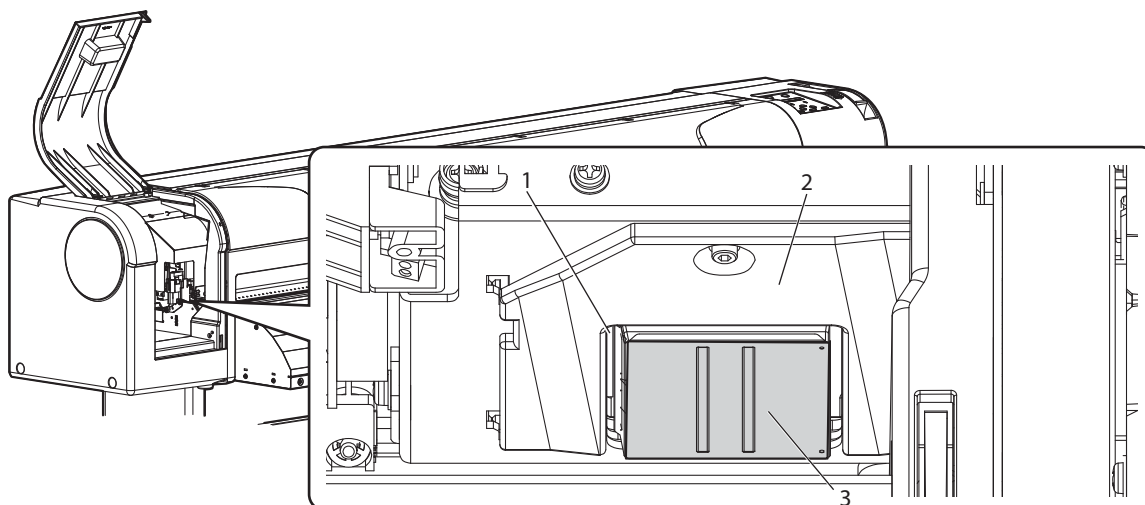

No.	Name
1	Around the print head
2	Head guide
3	Nozzles

7. When some foreign substance such as dust or ink clump is attached, use the cleaning stick to remove it.

CAUTION

- **When cleaning around the print head,**
 - **do not touch the nozzles of the print head.**
Doing so may damage the print head.
 - **Do not touch the tip of the cleaning stick.**
The oil from your hands will cause damage to the print head.
 - **Never use wet cleaning sticks.**
Doing so may damage the print head.
 - **Do not reuse the cleaning stick.**
Dust on the stick may damage the print head.

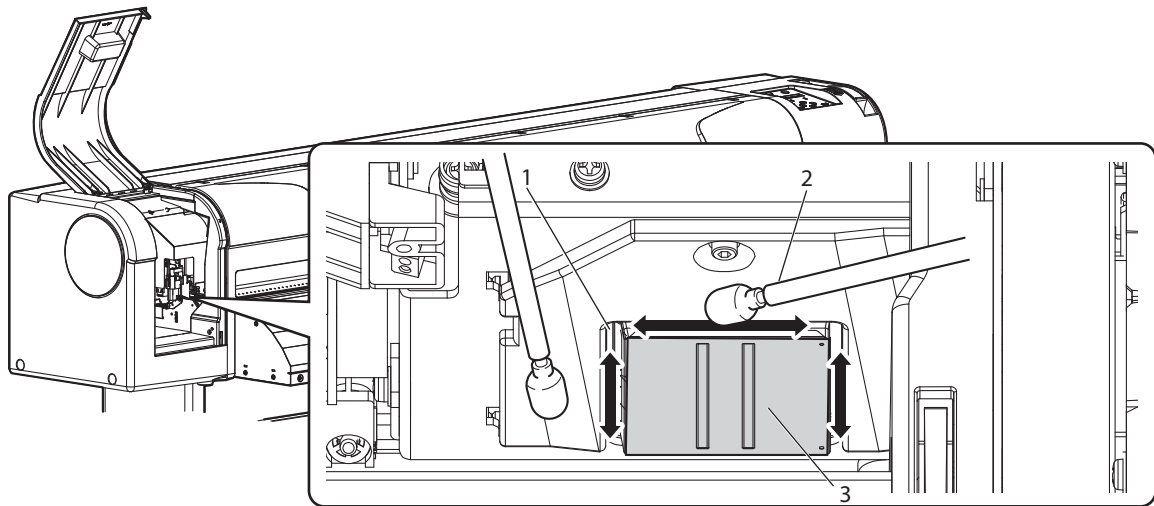

No.	Name
1	Around the print head
2	Head guide
3	Nozzles

8. Close the maintenance cover L.

- Close the cover firmly until it is locked.

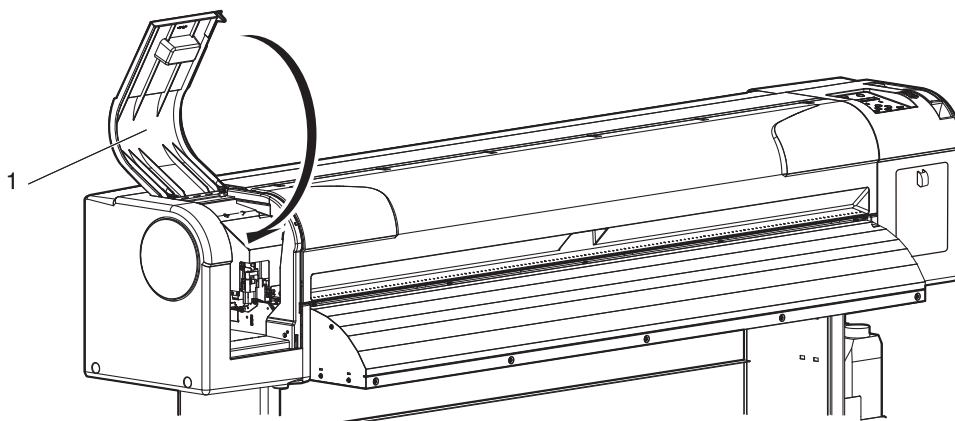

No.	Name
1	Maintenance cover L

9. Press the [Enter] key on the operation panel.

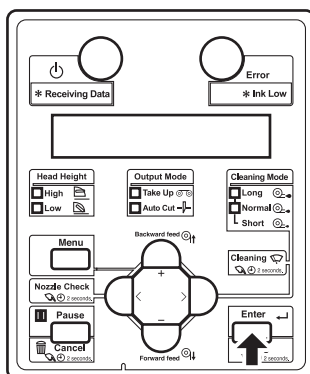

- The print head returns to its original position.
- “CR Maine.: Start” is displayed on the operation panel.

10. Press the [Menu] key on the operation panel.

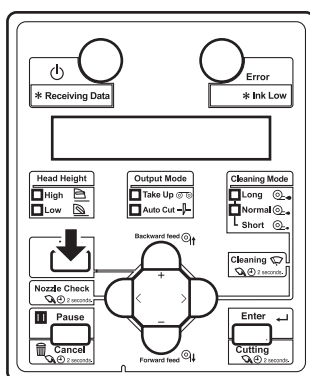

- "Ready to Print" is displayed on the operation panel.
- Cleaning around the print head is complete.

6.2.7 Cleaning the color sensor

This section describes how to clean the color sensor.

(1) When to clean

If you repeatedly failed to perform an auto print quality calibration (Adjust Print).

(2) Cleaning procedures

Follow the procedure below to clean the color sensor.

NOTE

- Before cleaning the color sensor, read this procedure thoroughly to fully understand it, and clean promptly and correctly.
 - While cleaning around the capping unit, with the cap removed from the print head, therefore cleaning must be done before the print head dries.
This operation should be done within 15 minutes.
If the operation lasts over 15 minutes, follow the Steps 8 and 9 to stop the operation and perform head cleaning, then resume cleaning.
 [6.2.3 Head cleaning](#)
 - Use the cleaning stick to clean the color sensor.
For details of the cleaning stick, refer to “[8.3 Options/Supply list](#)”.
-

1. If the printer is turned ON, make sure the following.
 - Printing or other operations are not in progress.
 - "Ready to Print" is displayed on the operation panel.

2. Go to the CR Maintenance menu on the operation panel.
 - a. Press the [Menu] key on the operation panel.

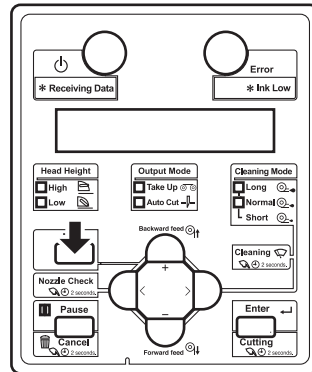

- “Menu1: Setup>” is displayed on the operation panel.
 - The operation panel shifts to the Setup menu display.
- b. Press the [>] key on the operation panel.

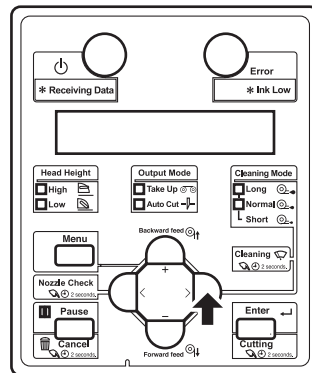

- “Set1: UserType” is displayed on the operation panel.
- c. Press the [+] key or [-] key to select “Set17: CR Maintenance”.

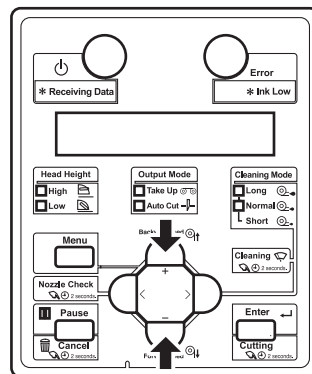

- d. Press the [Enter] key on the operation panel.

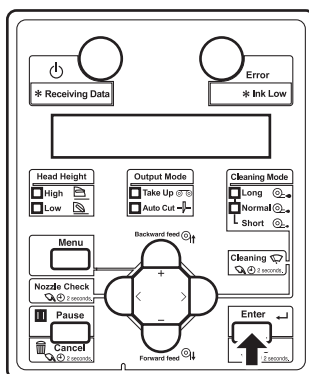

- “CR Maine.: Start” is displayed on the operation panel.
- The display enters the CR Maintenance menu.

5.1.15 CR Maintenance menu

3. Press the [Enter] key on the operation panel.

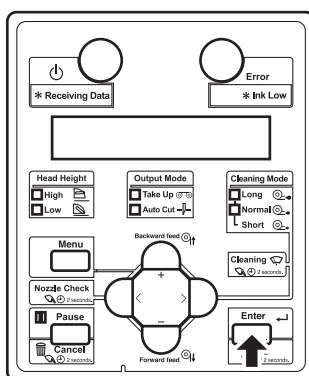

- Maintenance starts.
- The print head moves to the left.
- “CR Maintenance: End” is displayed on the operation panel.

4. Open the maintenance cover L.

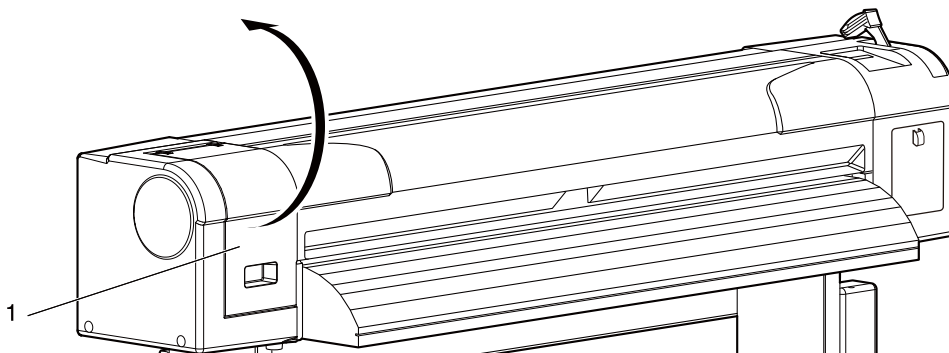

No.	Name
1	Maintenance cover L

5. Move the print head section by hand to where the circumference of the color sensor is visible.

CAUTION

- Do not press the Print head section strongly. Doing so may cause damage or poor print results.

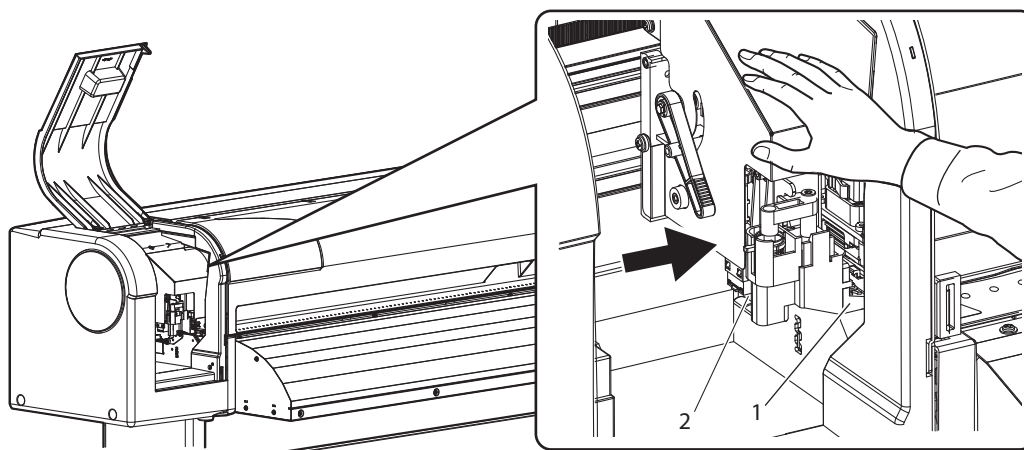

No.	Name
1	Print head section
2	Color sensor

6. Use a penlight, etc to check if any foreign substance, such as dust or ink clump, is attached to the following places.

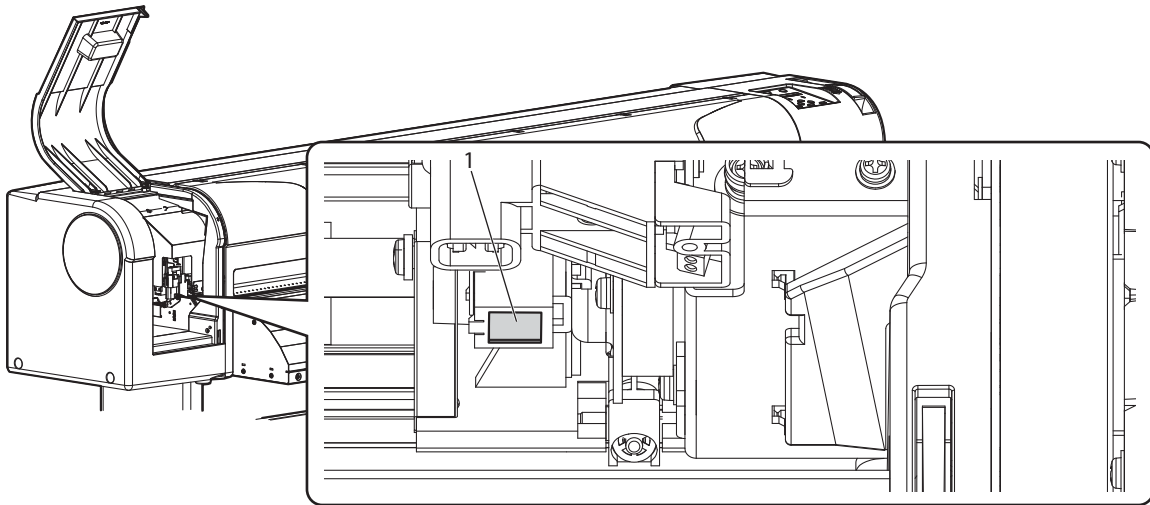

No.	Name
1	Color sensor

7. Using a cleaning stick slightly dampened with ethanol, gently clean the glass on the color sensor located at the bottom of the carriage to remove ink and dust.

CAUTION

- **When cleaning the color sensor,**
 - **Do not touch the nozzles of the print head.**
Doing so may damage the print head.
 - **Do not touch the tip of the cleaning stick.**
The oil from your hands will cause damage to the print head.
 - **Never use wet cleaning sticks.**
Doing so may damage the print head.
 - **Do not reuse the cleaning stick.**
Dust on the stick may damage the print head.
 - **Do not push the glass on the color sensor too hard with a cleaning stick.**
This will damage the glass.

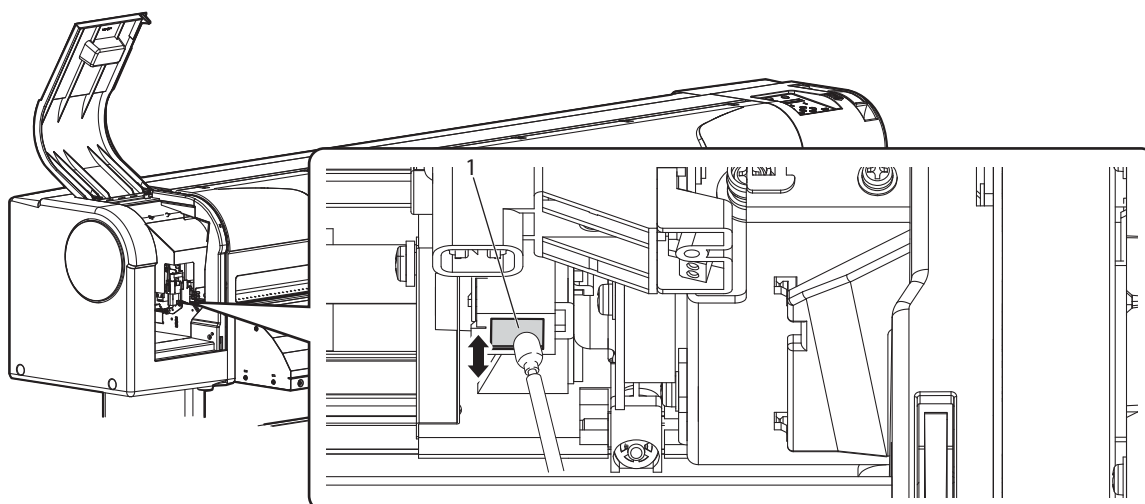

No.	Name
1	Color sensor

8. Close the maintenance cover L.
 - Close the cover firmly until it is locked.

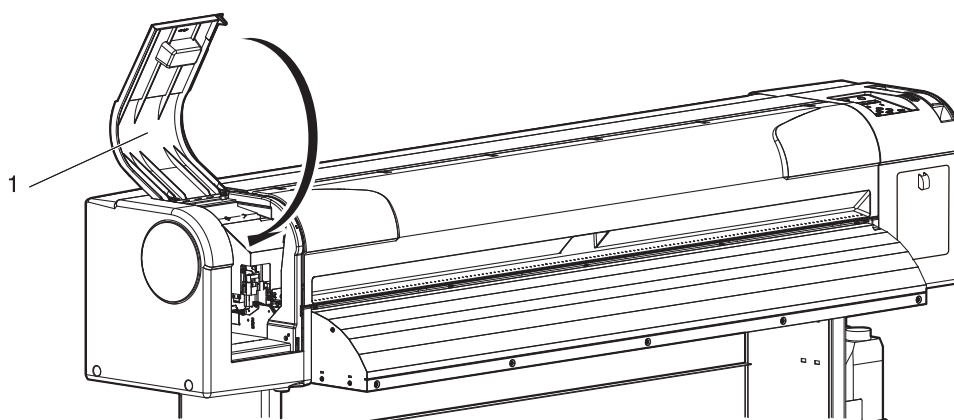

No.	Name
1	Maintenance cover L

9. Press the [Enter] key on the operation panel.

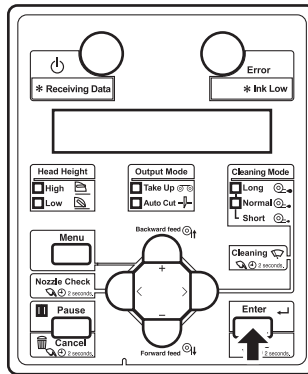

- The print head returns to its original position.
- “CR Maine.: Start” is displayed on the operation panel.

10. Press the [Menu] key on the operation panel.

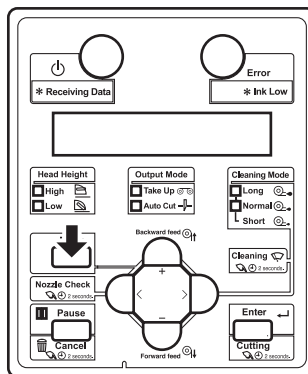

- "Ready to Print" is displayed.
- Cleaning around the print head is complete.

6.3 Disposal of waste fluids

The timing and method for the disposal of waste fluid are described below.

(1) Disposal timing

Dispose of waste fluids in the following cases:

- a. When the waste fluid tank is more than half full.
- b. When “Waste Ink Tank Full” is displayed on the operation panel.

(2) Disposal method

Follow the procedure below to dispose of waste fluid.



- **Waste ink collected from this product is classified as industrial waste. Dispose of waste ink according to the local waste disposal regulations.**



- **Wear protective equipment (gloves, goggles or eye protection, protective mask, protective clothing) when handling ink. Avoid contact with skin or eyes.**
 - **If in eyes or on skin, wash with water immediately.**
 - **Otherwise slight irritation or bloodshot eyes may occur. If irritation is present, seek medical advice/ attention immediately.**

1. Prepare an empty container to collect waste fluid from the tank.
2. Use waste paper to cover the floor under the waste fluid tank.

- Open the waste fluid valve, and drain the waste fluid to the container.

NOTE

- When draining the waste fluid to the empty container, the waste fluid may spatter. Make sure to put the container close to the waste fluid valve.

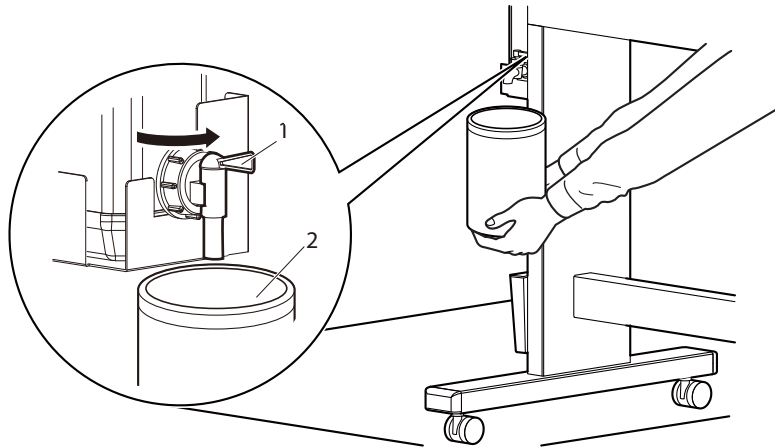

No.	Name
1	Waste fluid valve
2	Empty container

- After emptying the waste fluid tank, close the waste fluid valve securely.

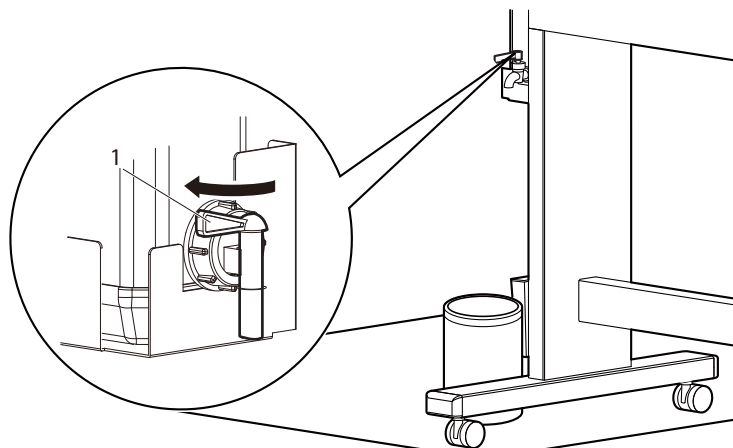

No.	Name
1	Waste fluid valve

- Wipe off the opening of the waste fluid valve with a cloth.
- Dispose of the waste fluid as an industrial waste product.
 - Disposal of waste fluids is completed.

6.4 Moving or transporting the printer

This section describes how to move or transport the printer.

6.4.1 Moving the printer

This section describes how to move the printer.

CAUTION

- **Keep the printer level while moving it.**
- **Do not tilt the printer, prop it against a wall or turn it upside down.**
The ink inside the printer may leak.
MUTOH cannot guarantee that the printer can run properly.

(1) Preparation before moving

When using the dedicated stands, follow the procedure below to move the printer.

1. Dispose of waste fluid.
 [6.3 Disposal of waste fluids](#)
2. Make sure that the printer is turned OFF.
3. Make sure that two wing bolts, securing the stand to the printer, and the hex socket bolts on the stand are not loose.
4. Make sure that the print head is located on the right edge.
5. Bundle the CR belts located in the center of the printer and clip them with the CR belt clip to fix them.

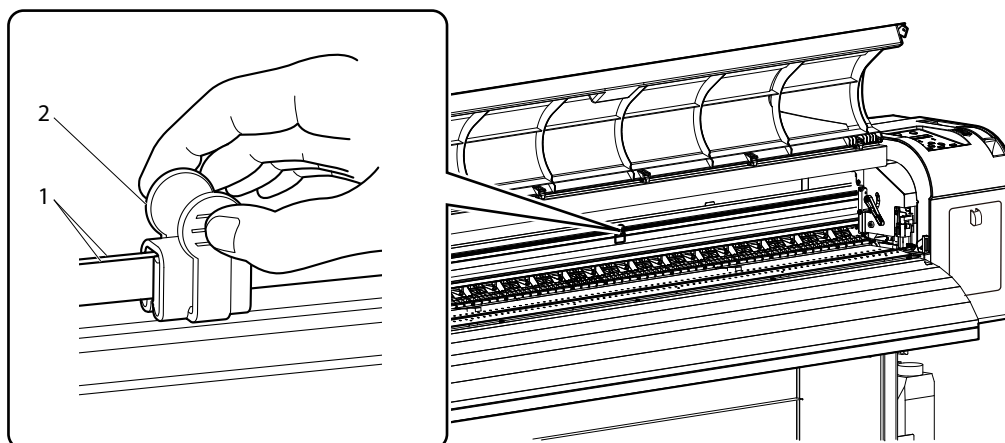

No.	Name
1	CR belts
2	CR belt clip

6. Remove the scroller.
7. Remove all the cables, such as the power cord.
8. Unlock the casters to move it.

NOTE

- The casters of the stand are designed to move the printer for short distance on a flat indoor floor. When moving the printer outdoors or where there are big bumps, remove the stand from the printer before moving.

 Installation manual

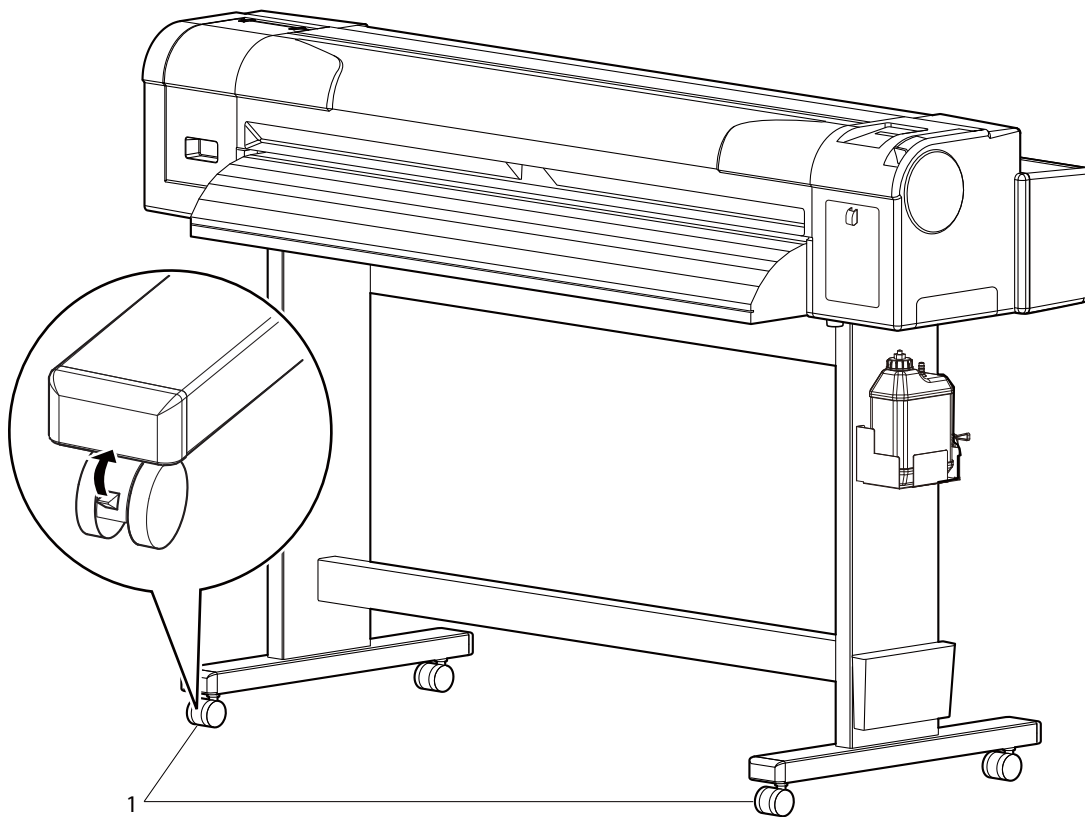

No.	Name
1	Casters

(2) Reinstalling

After moving the printer, follow the procedure below to set it ready for use.

1. Select a suitable place for installation.
☞ Installation manual
2. Move and install the printer to the location.
3. When the printer is mounted on the stand, make sure that two wing bolts, securing the stand to the printer, and the hex socket bolts on the stand are not loose.
4. Connect all the cables including power cord.
☞ [3.1 Power cord connection](#)
☞ [3.7 Connecting the printer to PC](#)
5. Run a nozzle check and make sure that there is no clogging in the print head.
☞ [3.5.1 Nozzle check](#)
☞ [3.5.2 Nozzle check F](#)
6. Perform Alignment.
☞ [3.6 Adjust Print](#)

6.4.2 Transporting the printer

When transporting the printer, make sure to pack it in the same condition as purchased, using protective and packing materials to protect the printer from vibration and shocks.

NOTE

- When transporting the printer, consult your MUTOH dealer you purchased this printer.
-

6.5 Long Storage and Initial Ink Charging

This section provides the cleaning procedure for long storage and initial ink charging steps next time when you use the printer.

6.5.1 Long-term storage

When you may not be able to run a weekly cleaning on the printer that is in sleep mode:

Perform "Longstore" and then power off the printer. It allows you to store the printer for up to one month (30 days).

1. Dispose of waste fluid.
[☞ 6.3 Disposal of waste fluids](#)
2. If the printer is turned ON, make sure the following.
 - Printing or other operations are not in progress.
 - "Ready to Print" is displayed on the operation panel.
3. Go to the Longstore menu on the operation panel.
 - a. Press the [Menu] key on the operation panel.

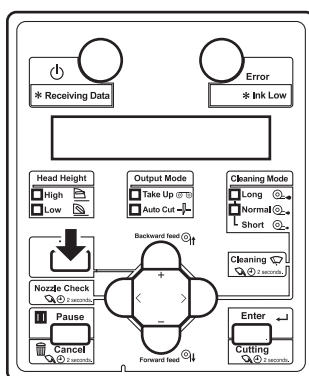

- "Menu1: Setup>" is displayed on the operation panel.
- The operation panel shifts to the Setup menu display.

b. Press the [>] key on the operation panel.

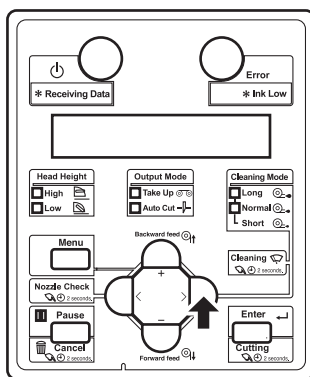

- “Set1: UserType” is displayed on the operation panel.

c. Press the [+] key or [-] key to select “Set16: Longstore”.

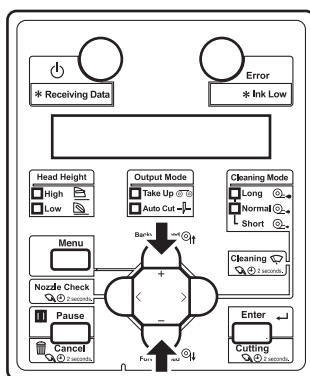

d. Press the [Enter] key on the operation panel.

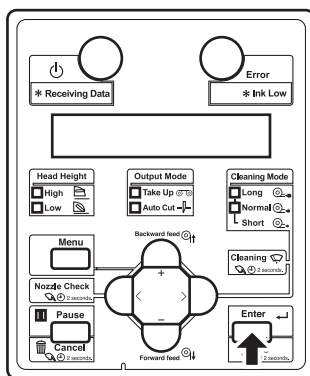

- “Longstore: Start” is displayed on the operation panel.
- The display enters the Longstore menu.

[5.1.14 Longstore menu](#)

4. Press the [Enter] key on the operation panel.

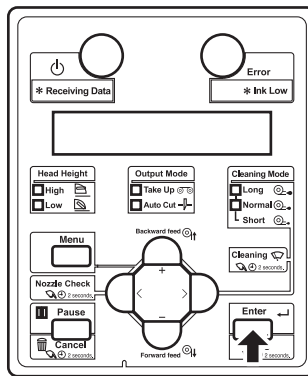

- “Remove Cartridges” is displayed on the operation panel.

5. Remove all ink cartridges or high capacity ink pack adapters from the slot.

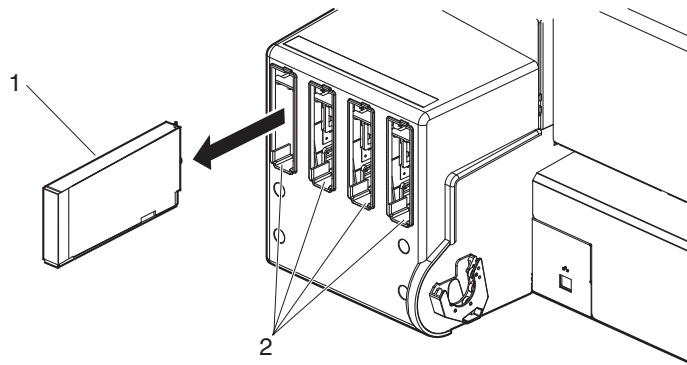

No.	Name
1	Ink cartridge
2	Ink cartridge slots

- “Discharging” is displayed on the operation panel and ink discharging begins.
- When the discharge is complete, “Insert CleaningCart.” is displayed on the operation panel.

6. Load the cleaning cartridges into the ink cartridge slots.

- Keep ▲ mark of the cleaning cartridge facing up and insert into the slot.
- Insert the cleaning cartridge all the way to the end of the slot.

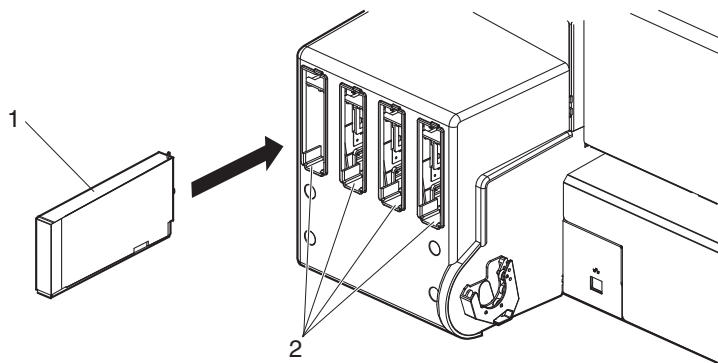

No.	Name
1	Cleaning cartridge
2	Ink cartridge slots

- When all cleaning cartridges are installed, “Busy-Washing” is displayed on the operation panel, and the printer starts charging the cleaning fluid.
- When the cleaning fluid has been charged, “Remove Cartridges” is displayed on the operation panel.

7. Remove all cleaning cartridges.

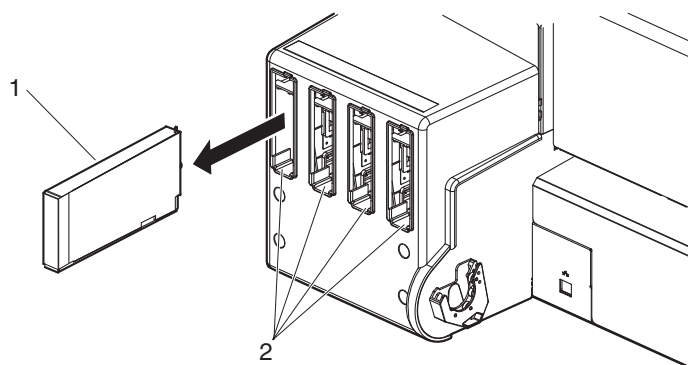

No.	Name
1	Cleaning cartridge
2	Ink cartridge slots

- “Busy-Washing” is displayed on the operation panel and the printer starts head cleaning.
- When head cleaning is complete, “[KCMY] Discharged” is displayed on the operation panel.

8. Press the [Power] key on the operation panel to turn OFF the printer.

- The Power lamp on the operation panel is turned off.

6.5.2 Performing initial charging after head cleaning

When powering on the printer after the long storage, follow these steps to perform initial ink charging.

1. Press the [Power] key on the operation panel to turn ON the printer.
 - Power lamp on the operation panel turns on (blue).

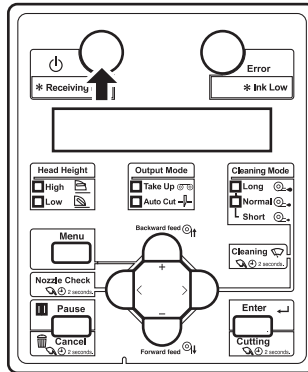

- The printer starts the initializing operation.
 - After the initial operation is complete, “Start Ink Charge –> E” is displayed on the operation panel.
2. Press the [Enter] key on the operation panel.

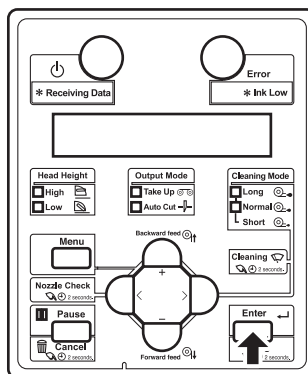

- “Insert InkCartridges” is displayed on the operation panel.
- When “Remove Cartridges” is displayed on the operation panel, remove all cartridges.

6.5.2.1 Installing 220 ml ink cartridges

1. Take out the new ink cartridge from the package.

NOTE

Be sure to use new ink cartridges. If a used cartridge does not have enough ink, it will run out during the initial ink charging and will consume more ink.

2. Agitate the ink cartridges.
 - Hold the ink cartridge facing the ink plug up and wait for 3 seconds.
 - Next invert the cartridge and wait for 3 seconds.
 - Repeat that 3 times.

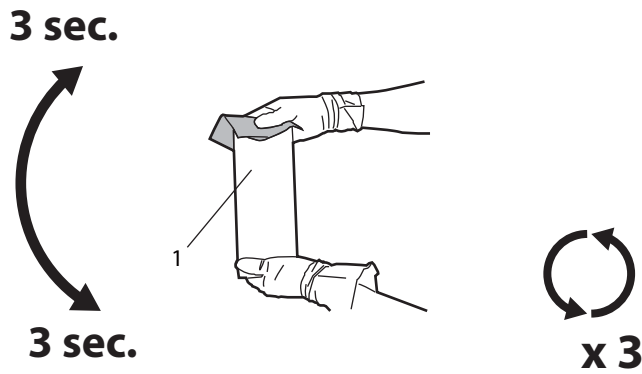

No.	Name
1	Ink cartridge

3. Insert the ink cartridges into their correct cartridge slots.

- Make sure that the ink cartridges are inserted into the correct slots. Match the mark in front of the slot and the color of the ink before inserting the ink cartridge.
- Keep ▲ mark of the ink cartridge facing up and insert into the slot.
- Insert the ink cartridge all the way to the end of the slot.

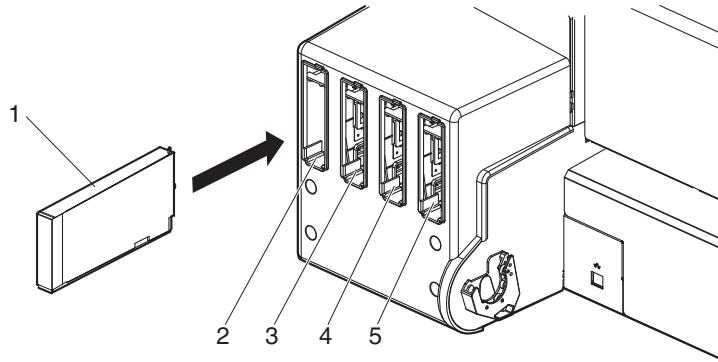

No.	Name
1	Ink cartridge
2	Ink cartridge slot K
3	Ink cartridge slot C
4	Ink cartridge slot M
5	Ink cartridge slot Y

- “Ink Refill **%” is displayed on the operation panel and initial ink charge starts.
- Initial ink charge takes about 13 minutes. Ink charging operation and pause operation are repeated during the initial ink charge.
- When “100%” is displayed, the initial ink charge is complete.

CAUTION

- **Do not perform the following operations during ink charging. If charging is interrupted, ink will be lost when charging is resumed.**
 - **Do not turn OFF the printer.**
 - **Do not unplug the power cord.**
 - **Do not open the front cover.**
 - **Do not open the maintenance cover.**
 - **Do not push the media loading lever towards the back.**

- After the initial ink charge is complete, “Media End” is displayed on the operation panel.

NOTE

- If the printer performs the nozzle check printing immediately after initial ink charge is complete, the following results may occur.
- Printed lines become blurred.
- The data is partially not printed.

In such cases, follow “**6.2.3 Head cleaning**” and perform “Little Charge”. Then, check the printing result.

If there is no improvement in the print result even after performing “Little Charge”, leave the printer unused for an hour or more. Then, perform “Little Charge” again and check the print result.

If there is still no improvement, contact your local MUTOH dealer.

6.5.2.2 Installing high capacity pack adapters (option)

1. Take out the new ink bag from the package.

NOTE

Be sure to use new ink bags. If a used bag does not have enough ink, it will run out during the initial ink charging and will consume more ink.

2. Install the ink bag and a smart chip card to the high capacity pack adapter.
3. Agitate the ink bag.
 - To avoid removing the ink bag from the high-capacity pack adapter, use one hand to hold the top of the ink bag. Rotate the plug of the ink bag vertically and hold for 3 seconds.
 - Then, invert the ink bag with the adapter and hold for 3 seconds.
 - Repeat that 3 times.

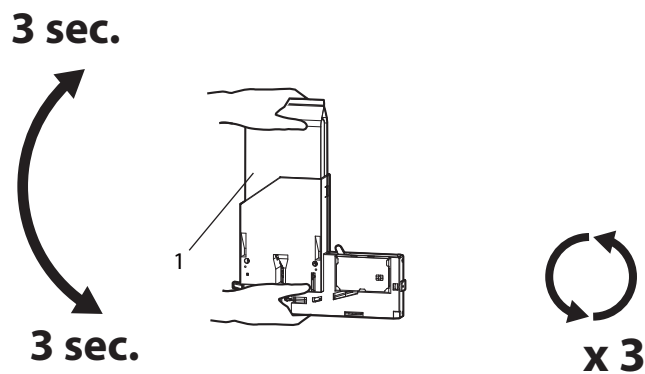

No.	Name
1	Ink bag

4. Insert the High capacity ink pack adapters into Ink cartridge slots.

NOTE

- Do not insert the high capacity pack adapter into the ink cartridge slot without a cleaning fluid bag attached.
The information of the remaining amount will be overwritten and the cleaning fluid bag will not be usable.

- Insert the high capacity pack adapter all the way to the end of the slot.

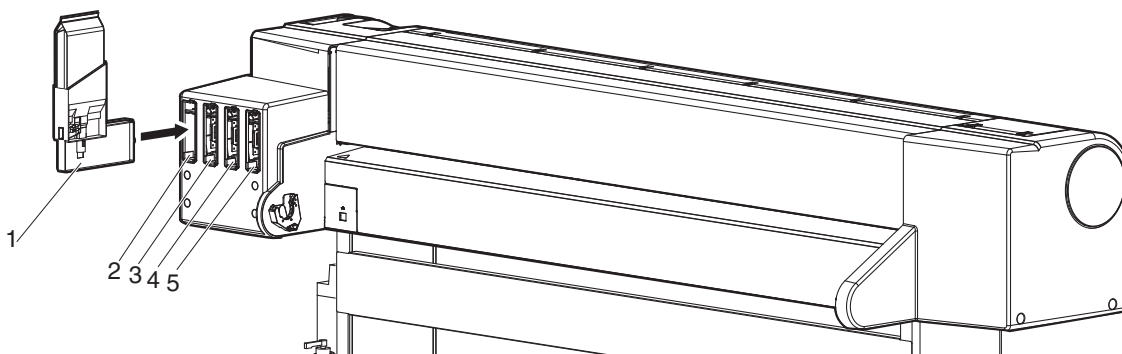

No.	Name
1	High capacity pack adapter
2	Ink cartridge slot K
3	Ink cartridge slot C
4	Ink cartridge slot M
5	Ink cartridge slot Y

- When a high capacity pack adapter is installed, “Ink Refill **%” is displayed on the operation panel and ink charging starts.
- Initial charging takes about 13 minutes.
Ink charging operation and pause operation are repeated during the ink charging.
- When “100%” is displayed, the ink charging is complete.

 CAUTION

- **Do not perform the following operations during ink charging. If charging is interrupted, ink will be lost when charging is resumed.**
 - **Do not turn OFF the power of the printer.**
 - **Do not unplug the power cord of the printer.**
 - **Do not open the front cover.**
 - **Do not open the maintenance cover.**
 - **Do not push the media loading lever towards the back.**

- After the ink charging is complete, “Media End” is displayed on the operation panel.

NOTE

- If the printer perform the nozzle check printing immediately after initial ink charging is complete, the following results may occur.
- Printed lines become blurred.
- The data is partially not printed.

In such cases, follow “[6.2.3 Head cleaning](#)” and perform “Little Charge”. Then, check the printing result.

If there is no improvement in the print result even after performing “Little Charge”, leave the printer unused for an hour or more. Then, perform “Little Charge” again and check the print result.

If there is still no improvement, contact your local MUTOH dealer.

7 Troubleshooting

This chapter describes possible troubles during the use of this product and countermeasures.

If the error not included in any items of this section occurs, contact your local MUTOH dealer.

NOTE







- If you want to receive product warranty, prepare the warranty certificate.
If the warranty certificate is not presented, the repair will not be covered by the warranty even if within the warranty period.
If you have signed a maintenance service contract, prepare that or a similar document.
-

7.1 Malfunctions and failures



This section describes undisplayed malfunctions and failures of the printer, possible causes and countermeasures.

7.1.1 Problems in installation and introduction

(1) Cannot perform the initial ink charge









No.	Possible cause	Remedy	Reference
1	Is the front cover open or media loading lever raised?	Close the front cover, or pull the media loading lever towards the front.	 3.4 Loading media
2	Is the maintenance cover open?	Close the maintenance cover.	 6.1.4 Replacing the cleaning wiper  6.2.4 Cleaning the cleaning wiper  6.2.5 Cleaning around the capping unit  6.2.6 Cleaning around the print head  6.2.7 Cleaning the color sensor
3	Are all four color ink cartridges (or high-capacity ink pack adapters) fully inserted?	Fully insert all four color ink cartridges (or high-capacity ink pack adapters).	 6.1.1 Replacing ink

(2) Ink does not come out after initial ink charge









No.	Possible cause	Remedy	Reference
1	Is the ink cartridge cold and frozen?	Leave the ink bag at room temperature for at least three hours, and perform cleaning several times.	 6.2.3 Head cleaning
2	Is the power turned OFF during initial ink charge?	Turn the power ON again and continue initial ink charge.	 3.3 Installing ink
3	Occasionally, normal printing cannot be performed after initial ink charge.	Perform cleaning several times, and check it every time.	 6.2.3 Head cleaning

7.1.2 Cannot print at all

(1) Does not work at all after power activation

No.	Possible cause	Remedy	Reference
1	Is the power cord connected to the plug?	Connect the power cord.	 3.1 Power cord connection
2	Does the AC power supply provide the specified voltage?	Connect the cable to another outlet.	 3.1 Power cord connection
3	Is the front cover open or media loading lever raised?	Close the front cover. Pull the media loading lever towards the front.	 3.4 Loading media
4	Is the maintenance cover open?	Close the maintenance cover.	 6.1.4 Replacing the cleaning wiper  6.2.4 Cleaning the cleaning wiper  6.2.5 Cleaning around the capping unit  6.2.6 Cleaning around the print head  6.2.7 Cleaning the color sensor

(2) Does not work after loading the media

No.	Possible cause	Remedy	Reference
1	Is the front cover open or media loading lever raised?	Close the front cover. Pull the media loading lever towards the front.	 3.4 Loading media
2	Is the maintenance cover open?	Close the maintenance cover.	 6.1.4 Replacing the cleaning wiper  6.2.4 Cleaning the cleaning wiper  6.2.5 Cleaning around the capping unit  6.2.6 Cleaning around the print head  6.2.7 Cleaning the color sensor
3	Is the media loaded at an angle?	Load the media straight.	 3.4 Loading media
4	Is the ink cartridge inserted?	Insert the ink cartridge.	 3.3 Installing ink

No.	Possible cause	Remedy	Reference
5	Is the printer being used in an environment other than the one specified, such as in direct sunlight?	Only use the printer in an environment that is specified for use.	☞ Installation manual

(3) When data is sent from the computer, an error occurs at the printer and nothing is printed

No.	Possible cause	Remedy	Reference
1	Is the type of printer selected correctly at the computer?	Check that the printer type settings on the computer side and printer side are the same.	☞ 3.7 Connecting the printer to PC
2	Are the interface requirements and command mode the same on the computer side and printer side?		

(4) Cannot use the computer online using LAN







No.	Possible cause	Remedy	Reference
1	Is the network interface cable connected correctly?	Confirm the types of the cross and straight cables, and connect the network interface cable correctly.	☞ 3.7.3 Connecting a network interface cable
2	Are the network settings configured correctly?	Configure the network settings correctly.	☞ 5.1.17 IP Address menu to 5.1.19 Gateway menu
3	Match the printer's network settings with the computer side environment.	Match this product's network settings with the computer side environment.	☞ 3.7.1 System requirements
4	Does the Power lamp on the operation panel turn on after sending printing data from the computer?	If the Power lamp does not turn on, contact the computer manufacturer.	—

7.1.3 Media-related troubleshooting

(1) The media slips or is torn during initialization

NOTE





- If the media is jammed or torn, remove it according to [7.3 The media has jammed](#).

No.	Possible cause	Remedy	Reference
1	Is the loading position of the media correct?	Set the media correctly.	 3.4 Loading media
2	Is the scroller set correctly?	Set the scroller correctly.	 3.4.1 Loading roll media
3	Are there any foreign materials such as paper attached to the pressurizing roller?	Clean the pressurizing roller.	 6.2.2 Cleaning the inside of the printer
4	Is the printer being used in an environment other than the one specified, such as in direct sunlight?	Only use the printer in an environment that is specified for use.	 Installation manual
5	Are you using folded, torn or rolled media?	Replace the media.	 4.2.2 Cautions on handling media
6	Does the media bend?	Set the Vacuum Fan menu.	 4.2.1 Media type  5.1.1.1.5 Vacuum Fan menu





(2) The media is crumpled during initialization

NOTE





- If the media is jammed or torn, remove it according to [7.3 The media has jammed](#).

No.	Possible cause	Remedy	Reference
1	Is the loading position of the media correct?	Set the media correctly.	 3.4 Loading media
2	Is the media loaded at an angle?	Set the media straight.	 3.4 Loading media
3	Are there any foreign materials such as paper attached to the pressurizing roller?	Clean the pressurizing roller.	 6.2.2 Cleaning the inside of the printer
4	Is the printer used in an environment other than the one specified, such as near an air conditioner?	Only use the printer in an environment that is specified for use.	 Installation manual
5	Are you using folded, torn or rolled media?	Replace the media.	 4.2.2 Cautions on handling media



(3) The wrong media size is set during initialization

No.	Possible cause	Remedy	Reference
1	Is the media loaded at an angle?	Set the media straight.	 3.4 Loading media
2	When the media is set, does it curl upward?	Straighten the media or set a new media.	 3.4 Loading media
3	Is the printer used in an environment other than the one specified, such as near an air conditioner?	Only use the printer in an environment that is specified for use.	 Installation manual
4	Are you using media that has been printed on already?	Use a new media.	 4.2.1 Media type

(4) Media jams frequently occur

No.	Possible cause	Remedy	Reference
1	Is the media used in an environment other than the one specified?	Use the media in a dedicated environment.	 4.2.2 Cautions on handling media
2	Are you using the old media?	Replace it with new media.	 6.1.2 Replacing Roll Media
3	Are you using the folded or wrinkled media?		
4	Does the media bend?	Set the Vacuum Fan menu.	 4.2.1 Media type  5.1.1.1.5 Vacuum Fan menu



(5) The media veers during printing

No.	Possible cause	Remedy	Reference
1	Is the loading position of the media correct?	Set the media correctly.	 3.4 Loading media
2	Is the scroller set correctly?	Set the scroller correctly.	 3.4.1 Loading roll media



7.1.4 Printing-related troubleshooting

(1) Printing is partially stained or incomplete





No.	Possible cause	Remedy	Reference
1	Does the media include moisture?	Replace it with new media.	 6.1.2 Replacing Roll Media
2	Are you using the folded or wrinkled media?		

No.	Possible cause	Remedy	Reference
3	Does the media bend?	Set the Vacuum Fan menu.	 4.2.1 Media type  5.1.1.1.5 Vacuum Fan menu





(2) The printing position is incorrect (some parts of the media cannot be printed on)

No.	Possible cause	Remedy	Reference
1	Is the loading position of the media correct?	Set the media correctly.	 3.4 Loading media
2	Did you set up the origin and print position?	Cancel or reset the settings of the origin and print position.	 5 Panel setup menu



(3) Printing is blurred

No.	Possible cause	Remedy	Reference
1	Is the media printed on the printing surface?	Confirm the printing surface of the media and set it correctly.	 3.4 Loading media
2	Did you perform Alignment?	Perform Alignment.	 3.6 Adjust Print
3	Did you perform Media feed adjustment?	Perform Media feed adjustment.	 4.2.6 Media feed adjustment
4	Is the head height set to High or Middle?	Return the head height to "Low".	 4.2.5 Printhead Height



(4) White or black lines appear on printed media

No.	Possible cause	Remedy	Reference
1	Is the scroller set correctly?	Set the scroller correctly.	 3.4.1 Loading roll media
2	Is the nozzle in good condition?	Perform Head cleaning.	 6.2.3 Head cleaning
3	Did you perform Alignment?	Perform Alignment.	 3.6 Adjust Print
4	Did you perform Media feed adjustment?	Perform Media feed adjustment.	 4.2.6 Media feed adjustment
5	Is the head height set to High or Middle?	Return the head height to "Low".	 4.2.5 Printhead Height

(5) Printing lines are not straight

No.	Possible cause	Remedy	Reference
1	Is the ink cartridge within the validity period?	Use a new ink cartridge.	 6.1.1 Replacing ink
2	Did you perform Alignment?	Perform Alignment.	 3.6 Adjust Print
3	Did you perform Media feed adjustment?	Perform Media feed adjustment.	 4.2.6 Media feed adjustment



(6) Printing lines are duplicated or patchy

No.	Possible cause	Remedy	Reference
1	Is the nozzle in good condition?	Perform Head cleaning.	 6.2.3 Head cleaning
2	Is the head height set to High or Middle?	Return the head height to “Low”.	 4.2.5 Printhead Height

(7) Print defects still occur after head cleaning.

No.	Possible cause	Remedy	Reference
1	Do you use the printer in the recommended printing environment?	If the humidity in the work area is below 40%, clogged nozzles may not be recovered by head cleaning. Make sure to use your printer in the recommended printing environment.	 8.1.1 Printer specifications > Recommended printing condition

(8) Media or platen gets dirty with ink after head cleaning.











No.	Possible cause	Remedy	Reference
1	Is the cleaning wiper cleaned regularly?	If a head cleaning is performed with a dirty cleaning wiper, the ink dirt may splash on the media or platen. Clean the wiper at least once a week.	 6.2.4 Cleaning the cleaning wiper
2	Is a cleaning wiper replaced regularly?	If a head cleaning is performed with a worn cleaning wiper, the ink dirt may splash on the media or platen. Replace with a new wiper at least once a year.	 6.1.4 Replacing the cleaning wiper



7.2 Error messages

This section describes messages displayed during normal printer operation or when errors occur, and solutions to the messages.

7.2.1 Status messages

When the product is operating correctly, each operation status is displayed on the operation panel as below.

No.	Display	Description	Reference
1	Ready to Print	Standby (Media is loaded).	—
2	Media End	Standby (Media is not loaded).	—
3	Receiving	Receiving data.	—
4	Analyzing data	Analyzing data.	—
5	Printing	Under printing.	—
6	PrintRestart -> Enter	Pausing printing. Press the [Enter] key.	—
7	Cleaning **%	Cleaning the head. Please wait a while.	 6.2.3 Head cleaning
8	Ink Refill **%	Charging the ink. Please wait a while.	 3.3 Installing ink
9	Moving Origin Pos.	The print head is moving to the original printing position in the Origin menu. Please wait a while.	 5.1.8 Origin menu
10	Confirm Position ->E	The print head is moving to the original printing position in the Origin menu. Press the [Enter] key.	 5.1.8 Origin menu
11	Head Cleaning	Cleaning Head. Wait for a moment.	 5.1.14 Longstore menu
12	Remove Cartridges	Performs head cleaning. Remove cartridges.	 5.1.14 Longstore menu
13	** Initialing **	Initializing the setting in the Initialization menu. Please wait a while.	 5.1.16 Initialization menu
14	Power Off	Turning the printer off. Please wait a while. Do not unplug the power cord till the operation panel is turned off.	 3.2.2 Turning the power OFF
15	Insert CleaningCart.	Washing the head. Install the cleaning cartridge.	 3.3 Installing ink
16	Insert InkCartridges	Charging the ink. Insert the ink cartridge.	 3.3 Installing ink















No.	Display	Description	Reference
17	User: Type ** OK?	Initializing the media.	 3.4.4 Specifying the User Type Setting
18	Media Initial	Please wait a while. (** represents the setup media type)	
19	No Media	The media is not loaded. Load the media.	 3.4 Loading media
20	Media Initial - Off	The printer is unable to display the "Roll Length Manage" menu because Media Initial is set to "Off".	 5.1.4 Media Initial menu













7.2.2 Message type error display and remedies

Message type errors are displayed when certain failures occur during printer operation.

If a message type error occurs, the printer may display the following error messages on the operation panel and stop operation.

If the printer stops operating, solve the error so that the printer restarts.

No.	Display	Description	Remedy	Reference
1	Cover Open	Front cover is open.	Close the front cover.	 3.4 Loading media
2	Maint. CoverL Open	Maintenance cover L is open.	Close Maintenance cover L.	 2.1 Names of parts and functions
3	Maint. CoverR Open	Maintenance cover R is open.	Close Maintenance cover R.	 2.1 Names of parts and functions
4	Lever Up	The media loading lever is pushed towards the back.	Pull the media loading lever towards the front.	 2.1 Names of parts and functions
5	Load Media	Media is not loaded.	Load a roll media in the printer.	 3.4 Loading media
6	Undefined Media	Media detection has failed. (Stops operation)	Reload the media.	 3.4 Loading media
7	Media Slant	Media is skewed. (Stops operation)	Reload the media.	 3.4 Loading media
8	Media Cut Error	The printer was unable to cut media. (Stops operation)	Reload the media.	 3.4 Loading media
9	Outside Print Area	The printer is unable to print because there is not enough printable width on the media. Adjust printable width by changing CR origin and side margin (left and right side margin) settings.	Printable width needed varies depending on the types of test print. Adjust the following settings to secure enough width.  5.1.1.1.3 Adjust Print menu (at least 550 mm)  5.1.1.1.4 Dist.Adj menu (at least 400 mm)  5.9 Roll Length Manage menu (at least 400 mm)	 5.1.3 Side Margin menu , 5.1.5 Media Width menu , 5.1.8 Origin menu
10	Roll Length - Off	The printer is unable to print because the "Roll Length" setting is set to "Off".	Specify the "Roll Length" settings and then select Print or Simple Print.	 5.9.4 Roll Length menu
11	Roll Remain Error	The remaining roll paper count has become 0. (Stops operation)	Load a new roll media.	 6.1.2 Replacing Roll Media
12	Roll Near End: *m	The remaining roll paper count is almost 0. The remaining roll paper is *m.	Prepare a new roll media.	 6.1.2 Replacing Roll Media

No.	Display	Description	Remedy	Reference
13	End Of Roll	Roll media has run out. (Stops operation)	Load a new roll media.	 6.1.2 Replacing Roll Media
14	Change Head Gap Low	The head height on the printer does not match with the one specified on the print data.	Change the height of the printer head.	 4.2.5.1 When raising the print head, 4.2.5.2 When returning the print head to the original position
15	Change Head Gap Mid			
16	Change Head Gap High			
17	[****] Ink Low	The remaining amount of ink is low. (Continues operation)	Replace with a new S/C card and ink cartridge.	 6.1.1 Replacing ink
18	[****] Ink End	Ink has run out. (Stops operation)	Replace with a new S/C card and ink cartridge.	 6.1.1 Replacing ink
19	[****] Check Ink	Printer cannot identify the ink cartridge or ink bag correctly.	Insert the ink cartridge or ink bag again.	 6.1.1 Replacing ink
20	[****] S/C ReadErr	The printer has failed to read the smart chip.	Insert the ink cartridge again. If the printer is still unable to read it, install a new ink cartridge.	 6.1.1 Replacing ink
21	[***] S/C Recog. E	An ink cartridge that needs smartchip recovery may have been installed.	Remove the ink cartridge and reload it. If the printer is still unable to read it, install a new ink cartridge.	 7.4.1 When the message “[***] S/C Recog. E” appears
22	[**] Check Color ->E	An ink cartridge that needs smartchip recovery may have been installed.	Check that the ink color of the cartridge inserted is correct. <ul style="list-style-type: none"> • In case of wrong color insertion, load a correct ink color cartridge. • If color is correct, press the [Enter] key. The printer will perform smart chip recovery and will continue to print. 	 7.4.2 When the message “[**] Check Color ->E” appears
23	[****] S/C Col.Err	The ink cartridge is inserted in the wrong slot.	Insert the ink cartridge into the correct cartridge slot.	 6.1.1 Replacing ink
24	[*] S/C Ink Err	The ink cannot be used for this printer.	Contact your local MUTOH dealer.	 6.1.1 Replacing ink
25	[*] S/C CodeErr	The ink cartridge inserted is not a proper one.	Contact your local MUTOH dealer.	—
26	[*] Broken Chip	The smart chip has been broken.	Replace with a new ink cartridge.	 6.1.1 Replacing ink
27	Full WasteInkTank	The waste fluid tank is full. (Stops operation)	Dispose of waste fluid.	 6.3 Disposal of waste fluids
28	Life Times [Pump]	The pump motor is nearing the end of its life. (Continues operation)	Contact your local MUTOH dealer.	—

No.	Display	Description	Remedy	Reference
29	Life Times [CR Motor]	The CR motor is nearing the end of its life. (Continues operation)	Contact your local MUTOH dealer.	—
30	Life Times [PF Motor]	The PF motor is nearing the end of its life. (Continues operation)	Contact your local MUTOH dealer.	—
31	[****] Change plug	The adapter plug of the optional high-capacity ink pack adapter must be replaced.	Replace with a new adapter plug.	 “3.2 Replacing Adapter’s plug” of High-capacity pack adapter manual.

NOTE

- [****] in an error message identifies where an error occurred.

7.2.3 Error requiring restart

An error requiring restart is displayed if a fatal operational failure such as the following occurs.

- When an obstacle that prevents printing occurs
- When a problem occurs with the electrical circuit (PCB, motor, sensor, etc.) of the printer
- When a failure in the printer control program occurs

If an error requiring restart occurs, the printer stops operating after performing the following operations.



1. The drive power automatically shuts down.
2. All lamps on the operation panel blink, and the buzzer rings continuously.
3. The error message is displayed on the operation panel.

Pressing any key on the operation panel stops the beeping.

For an error requiring restart, operation will return to normal after removing the cause of the error and restarting the printer.

If the same error continues to be displayed, contact the your local MUTOH dealer.

Be sure to tell us the code no. of the error message when you contact us.

No.	Display	Description	Remedy	Reference
1	E*** Error []	A problem that does not have a remedy has occurred.	<ol style="list-style-type: none"> 1. Remove obstacles such as paper scraps in the drive system. 2. Confirm that the replaced items are correctly attached. 3. Turn OFF the printer power, and turn it ON again after 10 seconds or longer. 	<p> 7.3 The media has jammed</p> <p> 6.1 Replacing consumable components</p>

NOTE

- “***” in the error message is the code no. that indicates what type of error occurred.
- The command code representing the error occurred may be indicated in [].
- For the settings on your PC side, refer to the Operating Manual attached with your PC.

7.3 The media has jammed

When the media jam occurred, follow the procedure below to remove it.

1. Turn OFF the power of the printer.
 ↳ [3.2.2 Turning the power OFF](#)
2. Open the front cover.

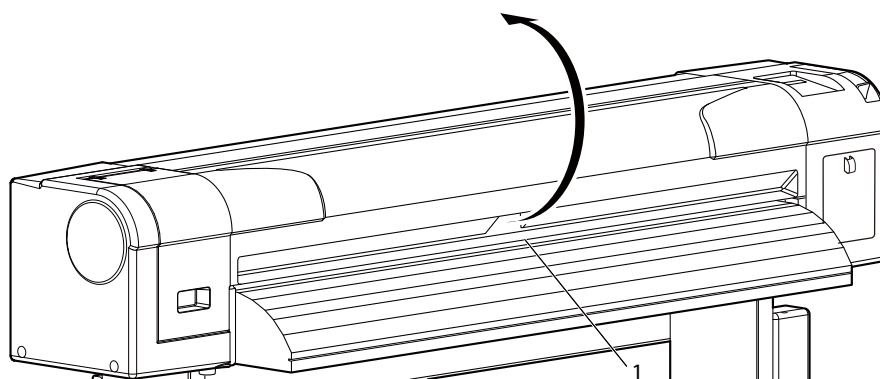

No.	Name
1	Front cover

3. Slide the print head carriage all the way to the right side.

NOTE

- When the head height is set to Low or Middle, switch it to High before moving the print head. Change the setting back to Low or Middle after moving the Head.
 ↳ [4.2.5.1 When raising the print head](#)
 ↳ [4.2.5.2 When returning the print head to the original position](#)

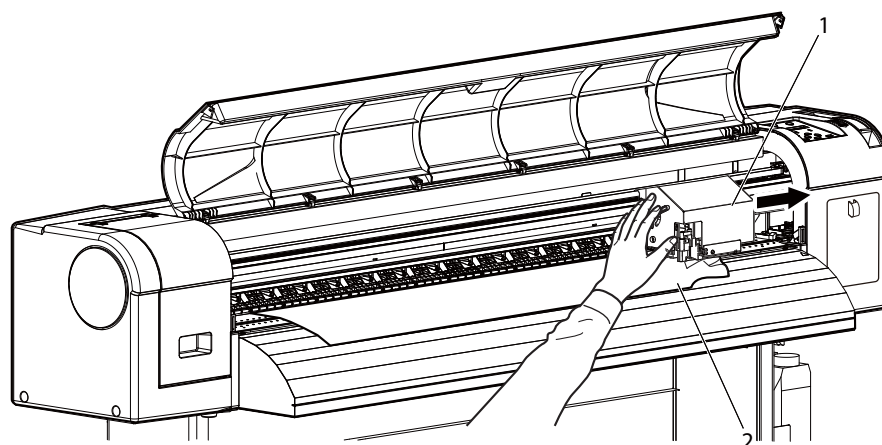

No.	Name
1	Print head carriage
2	Roll media

4. Push the media loading lever towards the back.

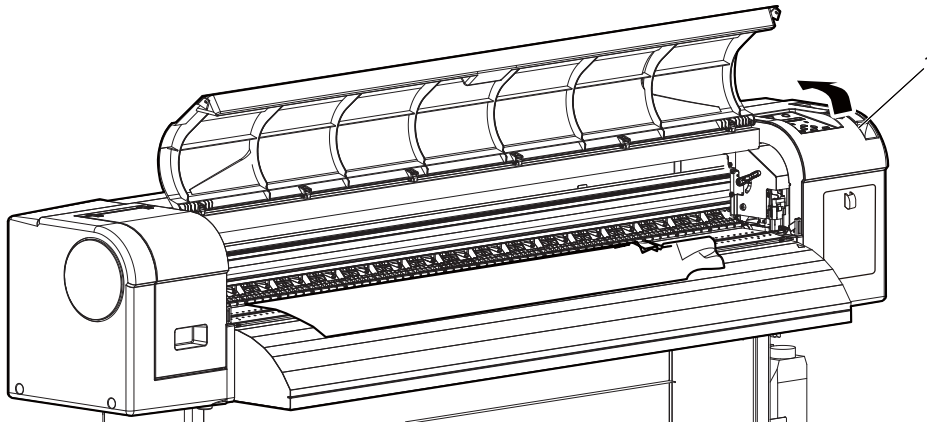

No.	Name
1	Media loading lever

5. Pull the media toward you and cut the torn part with a cutter.

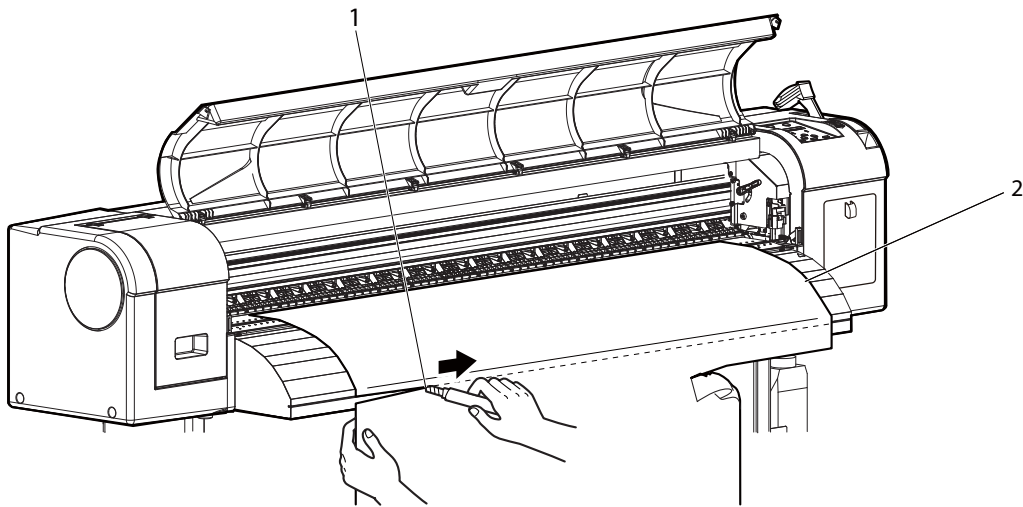

No.	Name
1	Razor blade
2	Roll media

6. Hold the both edges of the scroller to rewind the roll media by hands.

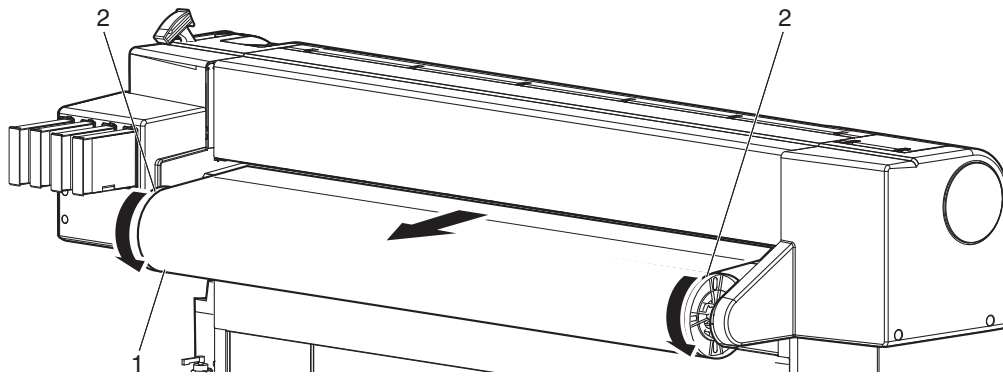

No.	Name
1	Roll media
2	Scroller

7. If a piece of paper remains inside the printer, remove them.

7.4 Smartchip Recovery

When the following message is prompted on the operation panel, a smartchip error such as broken chip may have occurred in the ink cartridge.

- [***] S/C Recog. E
- [**] Check Color ->E

Check that the correct color is inserted in the cartridge slot and perform smartchip recovery. This will allow you to continue to print.

To perform smartchip recovery, do one of the followings according to the message appeared.

7.4.1 When the message “[***] S/C Recog. E” appears

Remove the ink cartridge and reload it. If the printer is still unable to read it, install a new ink cartridge.

- If a message “[**] Check Color ->E” appears after the ink cartridge is reloaded, follow the section ["7.4.2 When the message “\[**\] Check Color ->E” appears"](#) to operate.

7.4.2 When the message “[**] Check Color ->E” appears

Check that the ink color of the cartridge inserted is correct.

- In case of wrong color insertion, load a correct ink color cartridge.
- If color is correct, press the [Enter] key. The printer will perform smart chip recovery and will continue to print.

NOTE

- During smartchip recovery execution, the ink cartridge being recovered blinks in the ink level indicator and ink status menu.

 [2.1.4.1 Ink level indicator](#), [5.5.1 Ink Status menu](#)

8 Appendix

This chapter describes specifications and included components with this printer.

8.1 Product specifications

8.1.1 Printer specifications

Items		Specification
Model name		XPJ-1341WR-P
Printing method		On-demand piezo drive system
Drive system		Firmware servo/DC motor drive
Media feed system		Multipoint pressurizing grid roller system
Media hold-down system		Pressurization roller down system by manual lever
Media feed/ejection	Roll media	Rear feed/Front ejection
Roll media outer diameter		150 mm or less
Roll media weight		19 kg or less
Maximum media width		1,371 mm
Minimum media width		500 mm
Maximum media thickness		0.3 mm (when the head height is Low) / 0.8 mm (when the head height is Middle) / 1.3 mm (when the head height is High)
Maximum printable width		1,361 mm
Print margin	Roll media	Top: 5 mm ^{*1,2} , Bottom: 5 mm (40 mm at the roll media end), Left: 5 to 25 mm, Right: 5 to 25 mm *1 15 mm (Immediately after media initialization, or when feeding the media backward) *2 40 mm (When Media Initial menu is set to "Top&Width", or after cutting the media)
Media cut system		Horizontal automatic cut system/manual cut system
Head height adjustment		Three adjustment options: Low/Middle/High
CPU		64-bit RISC CPU
Memory		256MB
Command		MH-RTL (RTL-PASS)
Interface		Network interface (Ethernet IEEE 802.3)
Ink	Supply system	Supplied through tubes from four-color independent cartridges
	Cartridges	Black, Cyan, Magenta, Yellow: 220 ml (1,000 ml when the optional high capacity pack adapter is used)

Items		Specification
Environmental condition	Operating condition	Temperatures: 20 °C to 32 °C Humidity: 40% to 60%, No condensation
	Recommended printing condition	Temperatures: 22 °C to 30 °C Humidity: 40% to 60%, No condensation
	Change rate	Temperature: within 2°C per hour Humidity: within 5 % per hour
	Storage condition (without ink filled)	Temperature: -20 °C to 60 °C Humidity: 20 % to 80 %, No condensation Storage life: six months
	Storage condition (with ink filled)	Temperature: -5 °C to 35 °C Humidity: 20 % to 80 %, No condensation Storage life: within 1 week* *In case stored in the temperature over 32 °C, the storage period should be within 4 days.
Power supply specifications	Power voltage	AC 100V to 120V ±10% AC 200V to 240V ±10%
	Frequency	50 Hz/60 Hz ± 1 Hz
	Current	AC 100V to 120V: 2.4 A or less AC 200V to 240V: 1.2 A or less
Power consumption	Power off	AC 100V to 120V: 0.5 W or less AC 200V to 240V: 1.0 W or less
	Sleep mode	14 W or less
	Standby	67 W or less
	Printing	190 W or less
Dimension	Height	1,218 mm (when mounting on the stand)
	Width	1,916 mm
	Depth	685 mm
Weight	Printer	approx. 61 kg
	Stand	approx. 20 kg

8.2 Interface specification

This section describes each type of interface specifications supported by this product.

8.2.1 Network interface specification

Items	Specification
Network type	Ethernet IEEE802.3
Network I/F	10BASE-T/100BASE-TX Automatic transfer type (RJ-45 Connector twist pair cable) MDI/MDI-X Automatic transfer
Corresponding protocol	TCP/IP

8.3 Options/Supply list

For more information about the options and the supply items, contact your local MUTOH dealer.

9 Setup menu diagram

For details of the Setup menu configuration diagram, refer to the followings.

NOTE

- For details of each setup item, refer to followings:
 - Setup menu diagram (Ready to Print):
☞ ["5 Panel setup menu"](#)
 - Setup menu diagram (Receiving / Converting / Printing):
☞ [4.4.6 Changing and confirming settings while printing](#)
 - The < > parts in each list are factory default settings (initial values).
-

Setup menu diagram (Ready to Print) (1/4)

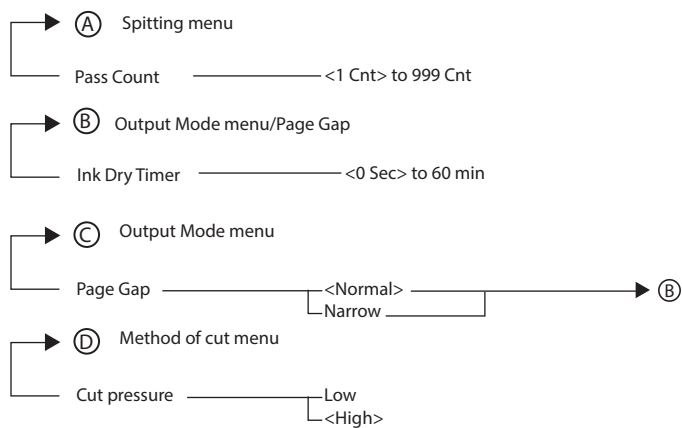
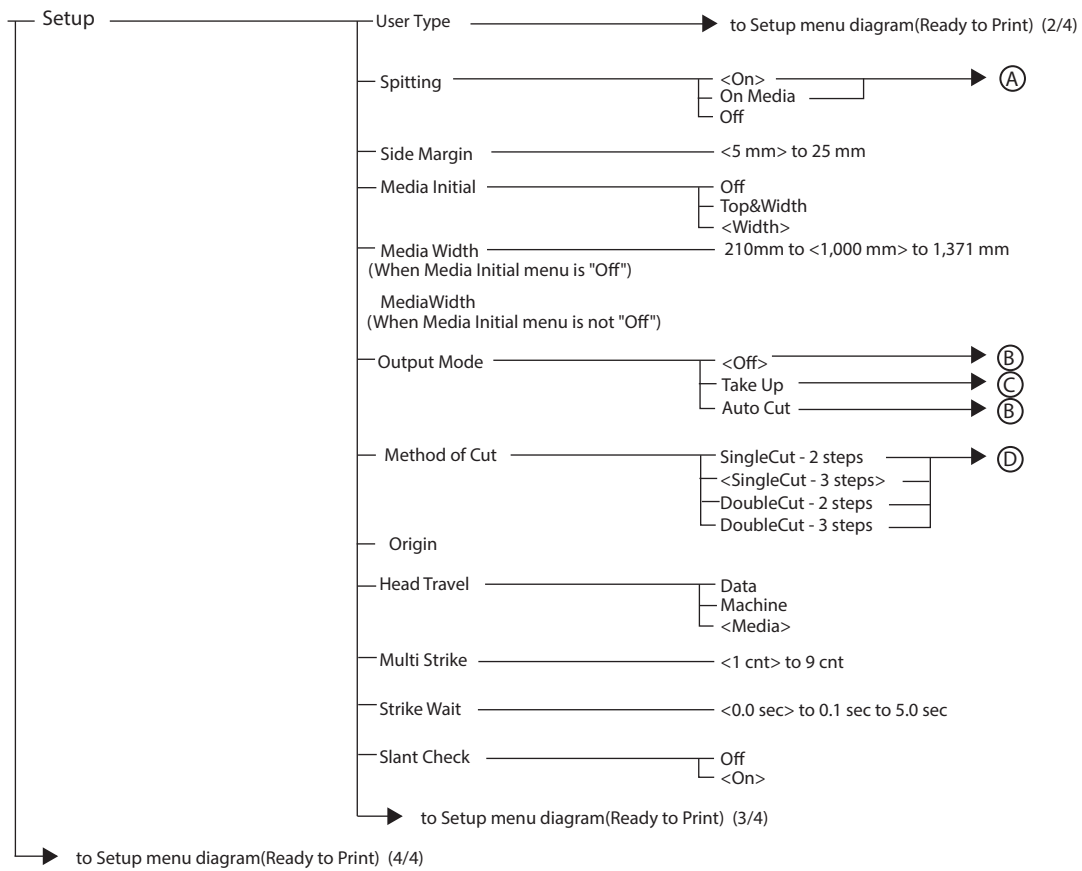

Setup menu diagram (Ready to Print) (2/4)

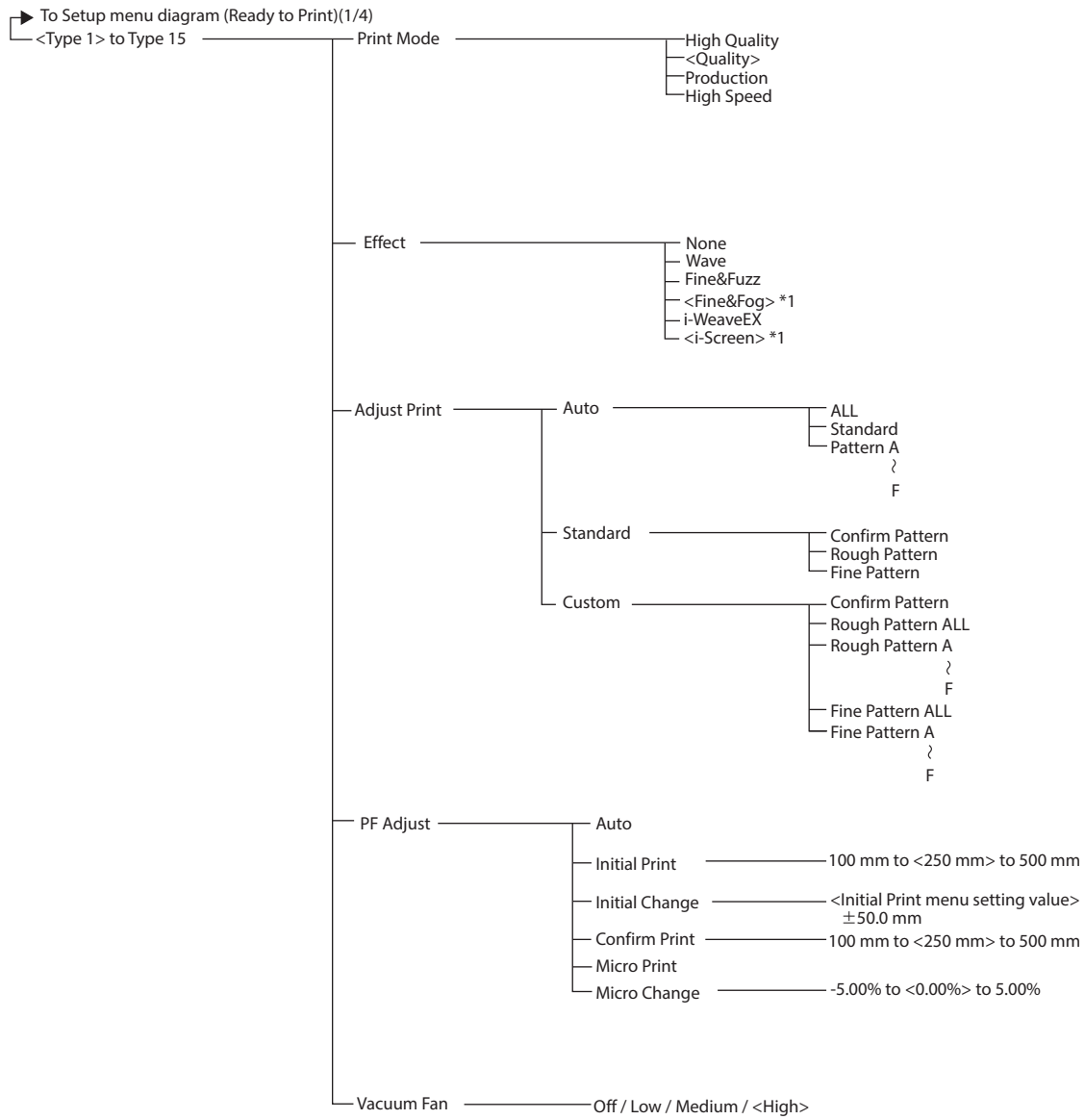

*1: The default value depending on print mode.

Print Mode	Effect Default Value
High Quality	i-Screen
Quality	i-Screen
Production	i-Screen
High Speed	Fine&Fog

Setup menu diagram (Ready to Print) (3/4)

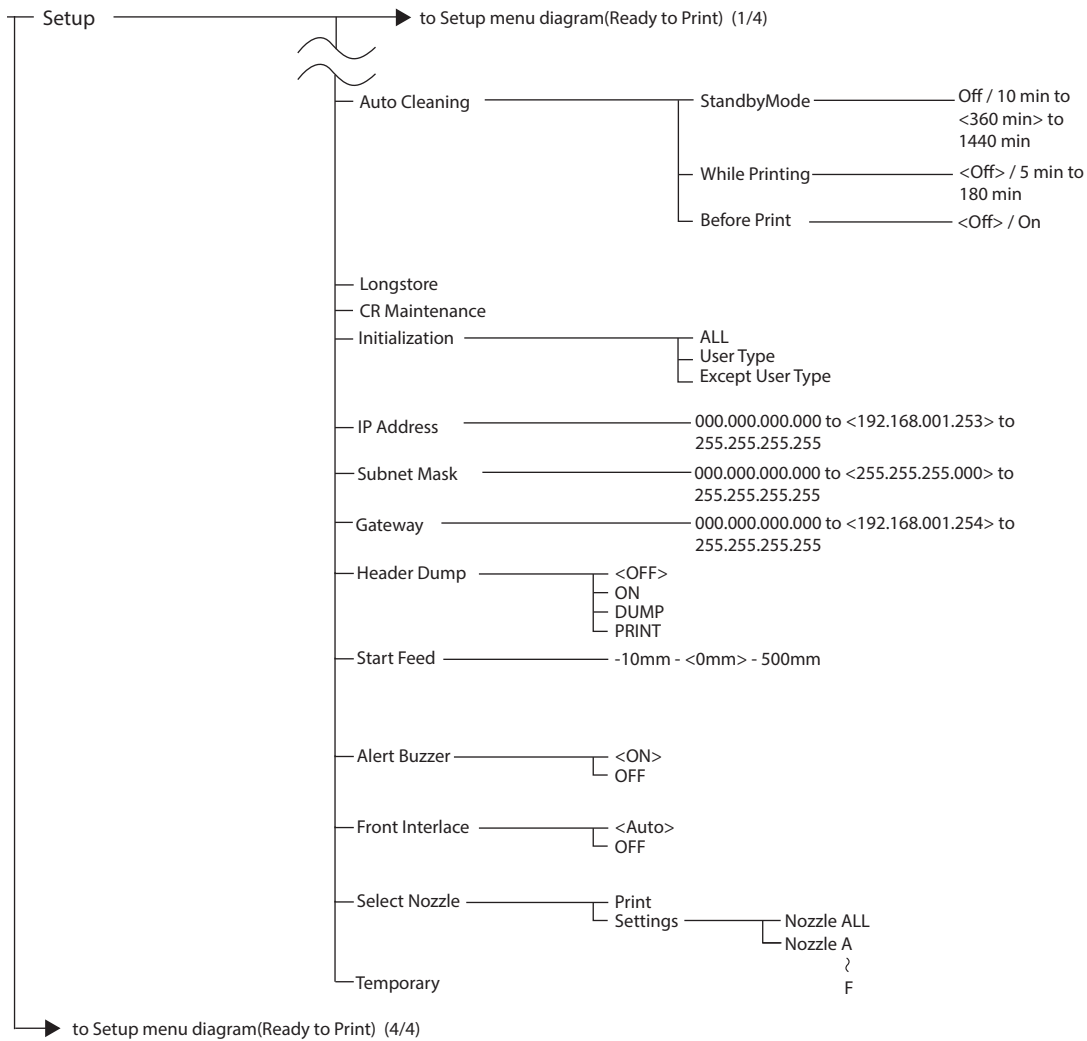

Setup menu diagram (Ready to Print) (4/4)

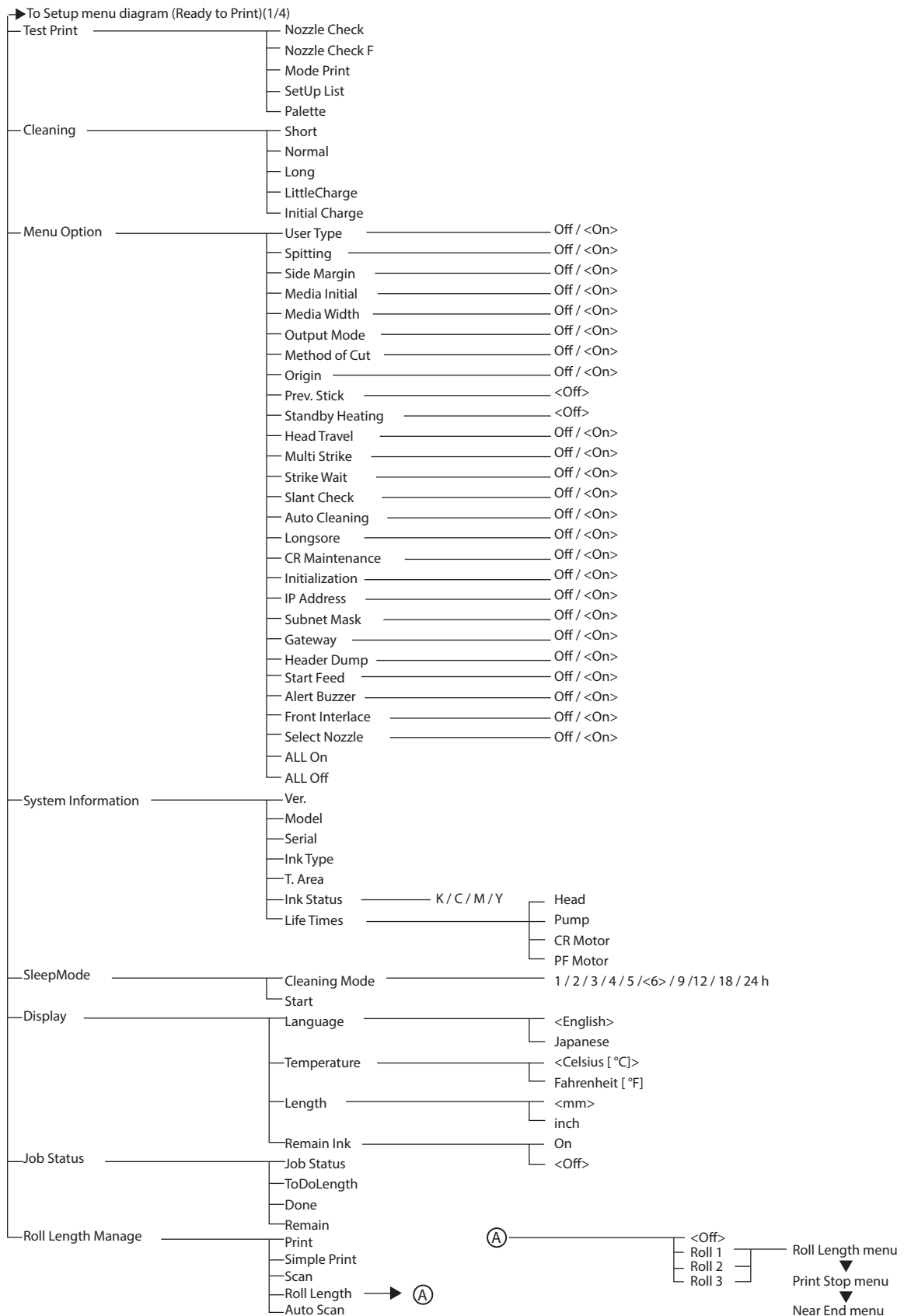

Setup menu diagram (Receiving / Converting / Printing)

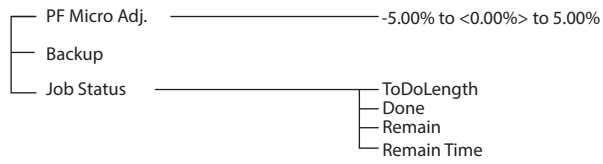

Revision History

General Information

Date	Version	Manual code	Supported Firmware
2022.2	00	XPJ1341WRPE-A-00	V.1.03
2023.3	01	XPJ1341WRPE-A-01	V.1.06 or later

MUTOH